

414

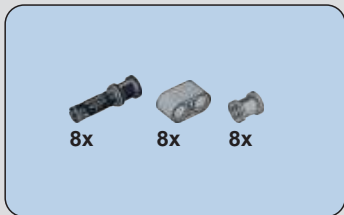

415

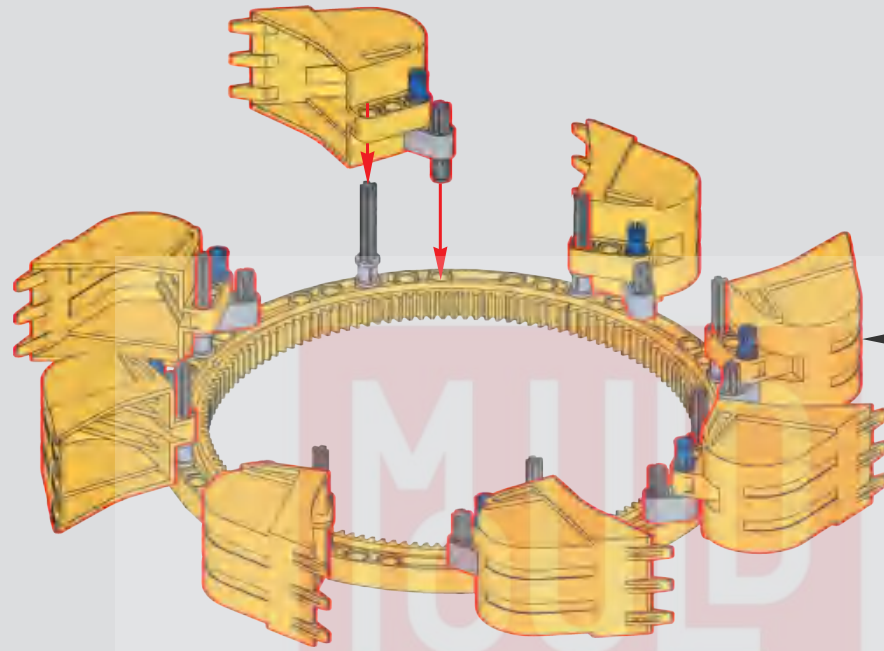
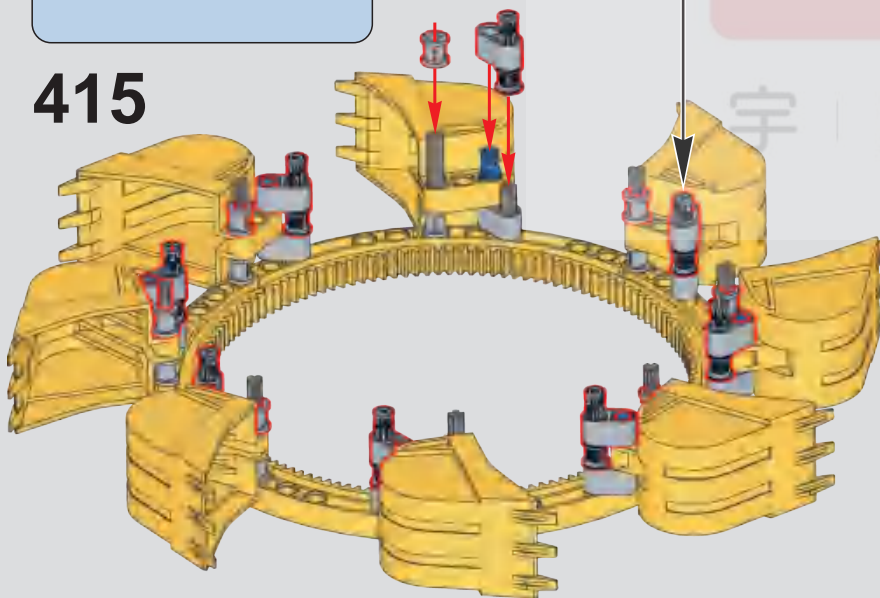

416

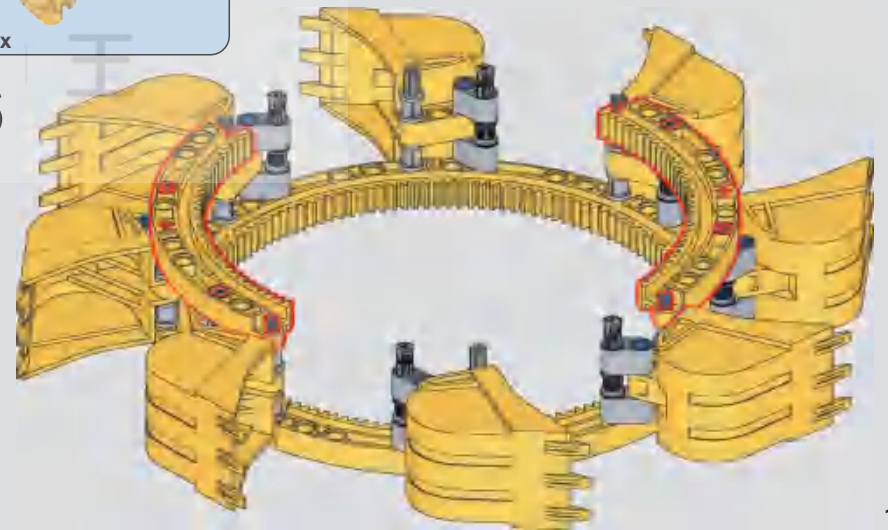

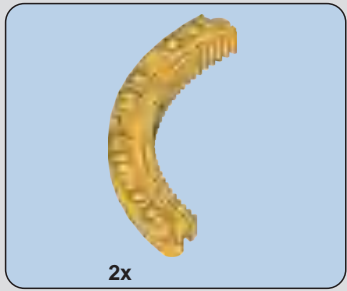

417

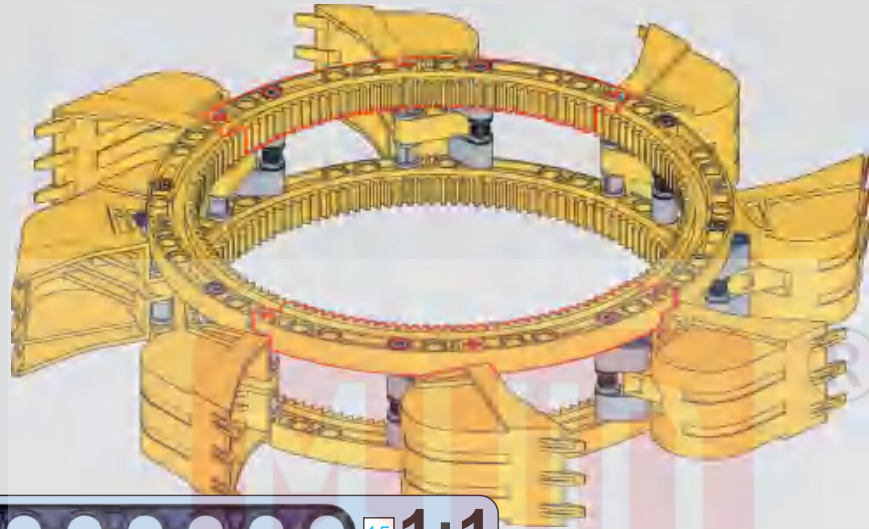

418

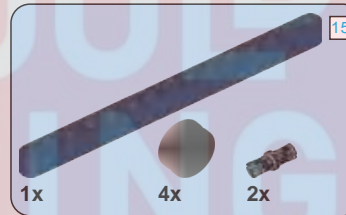

419

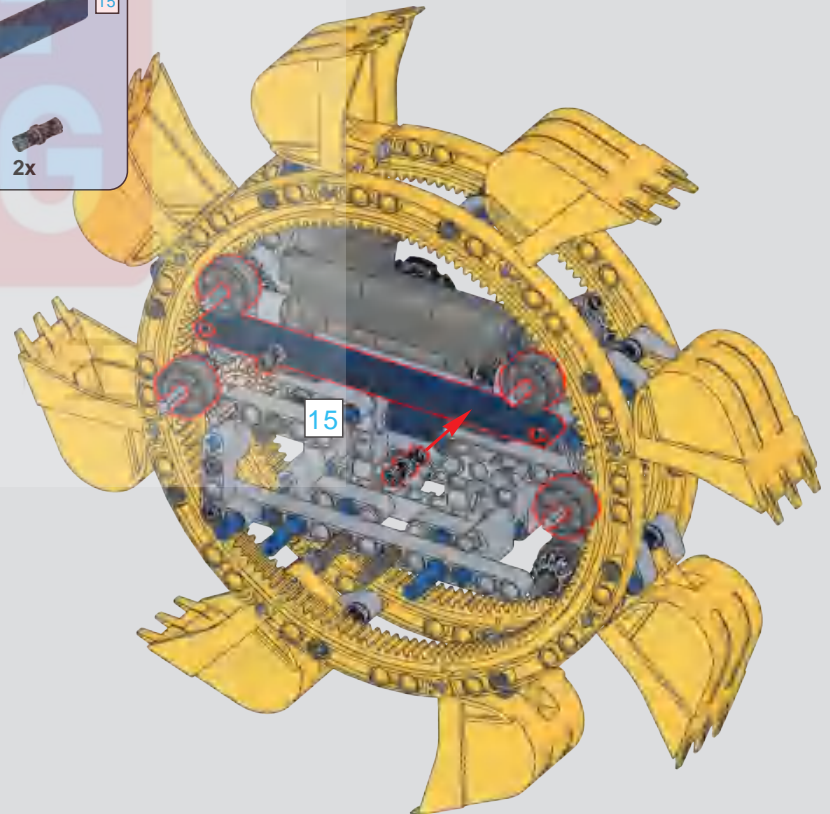

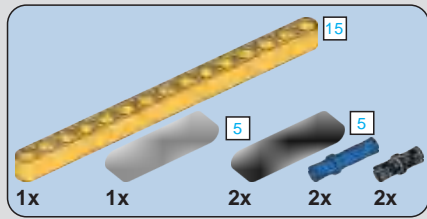

420

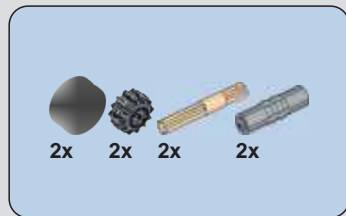
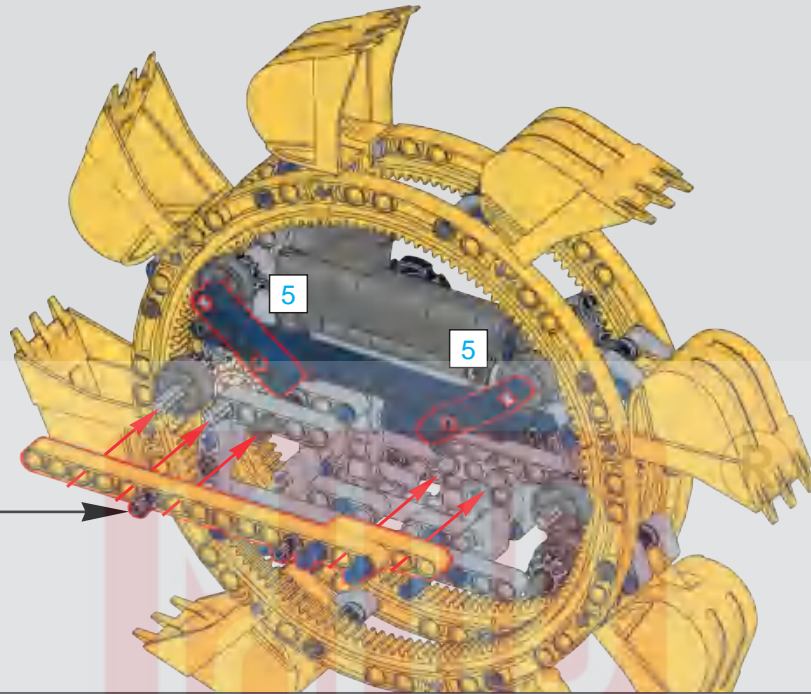
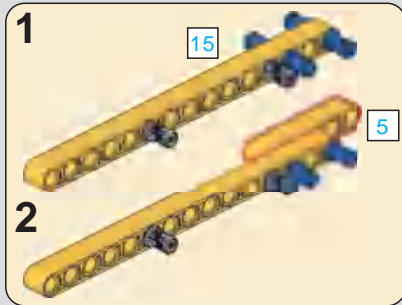

421

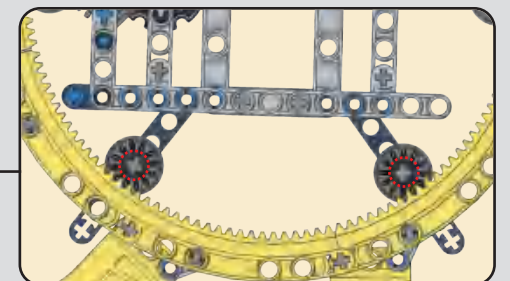
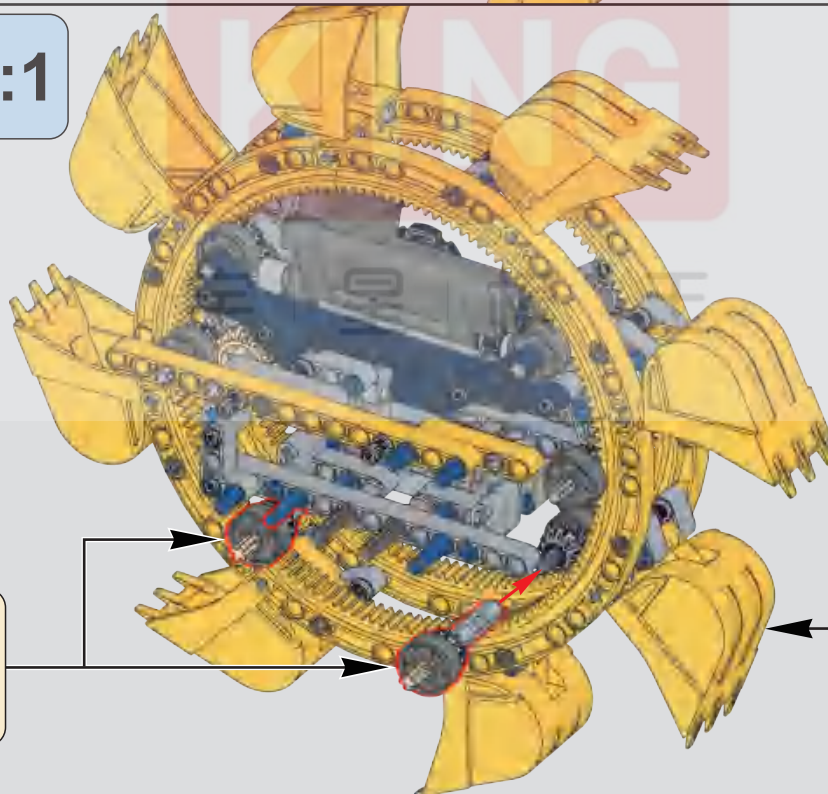
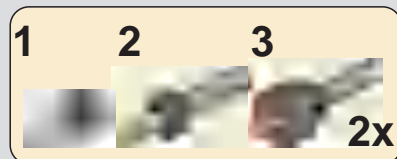

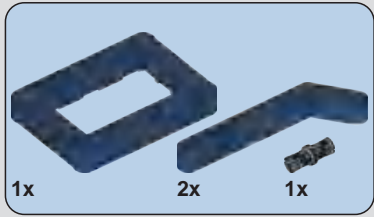

422

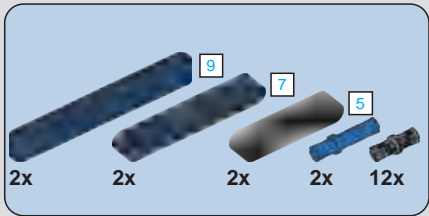
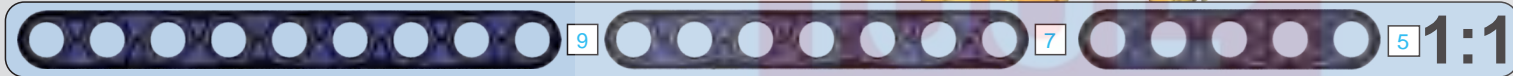
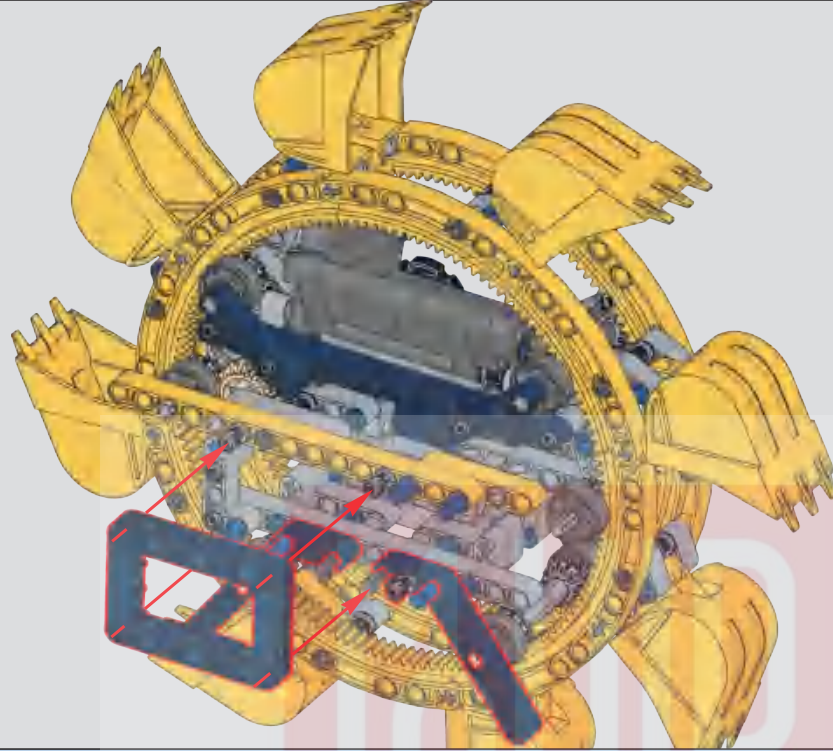

423

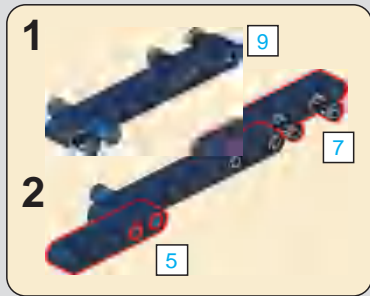

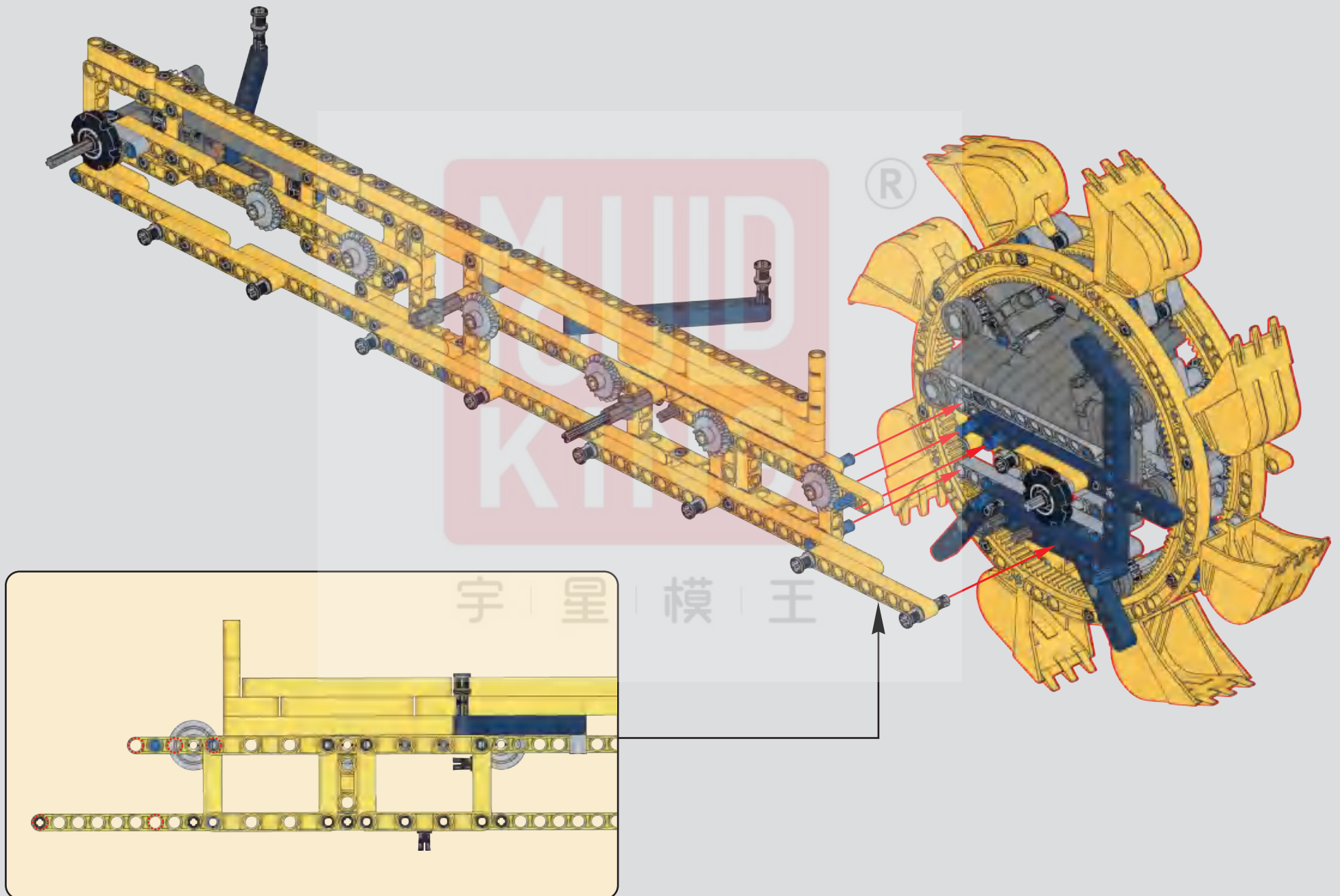

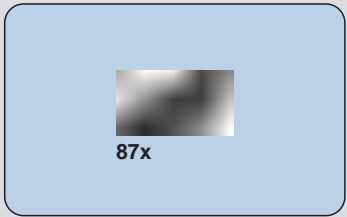

425

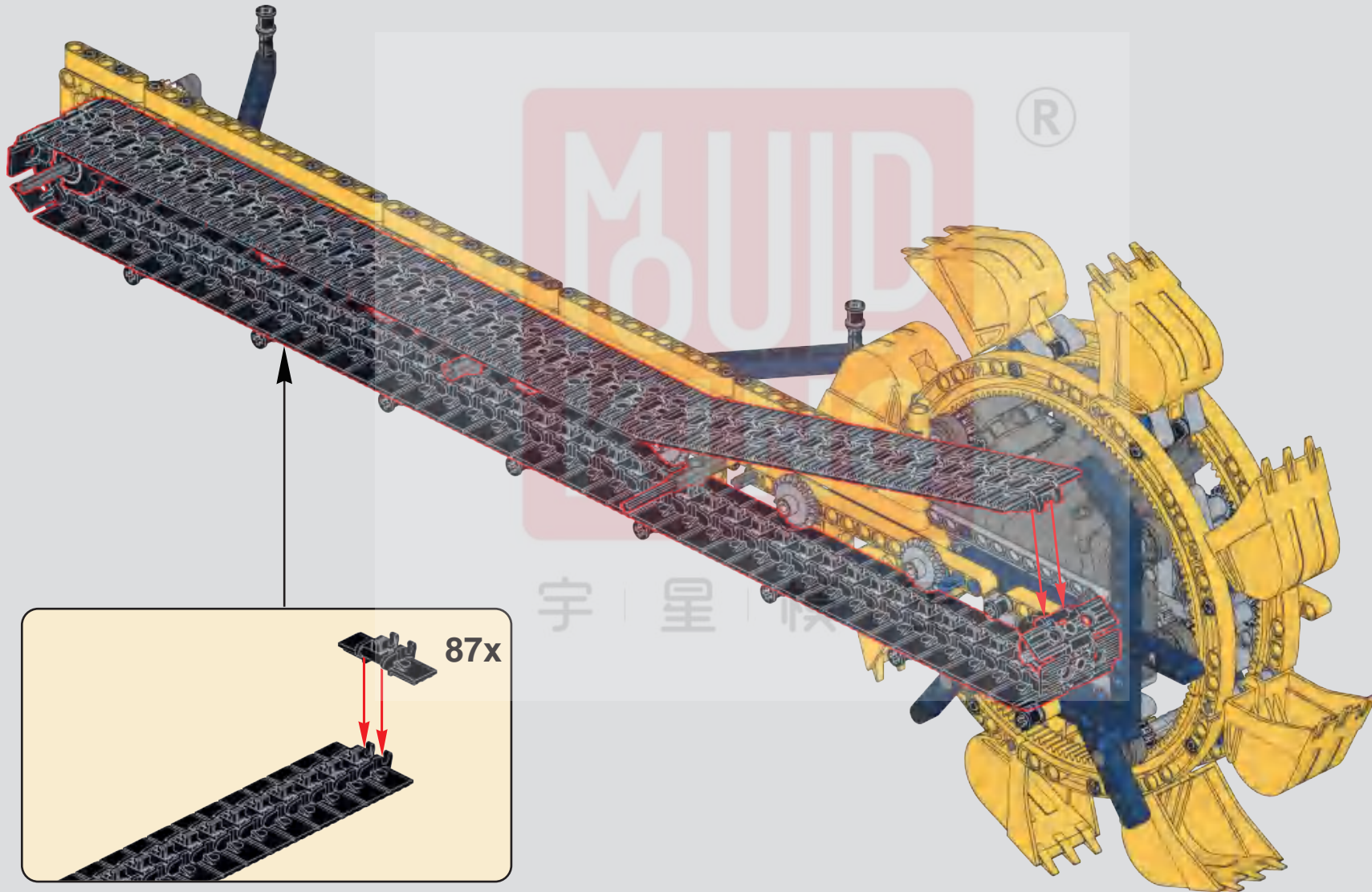

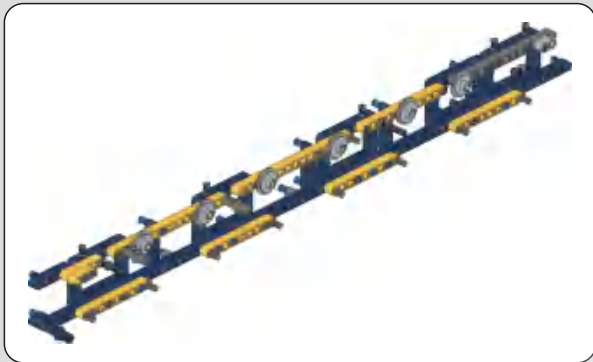

426



427

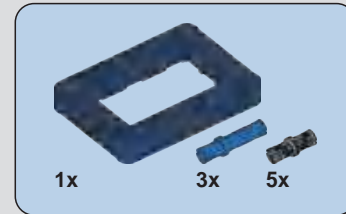

428

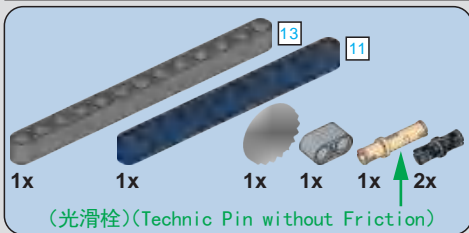
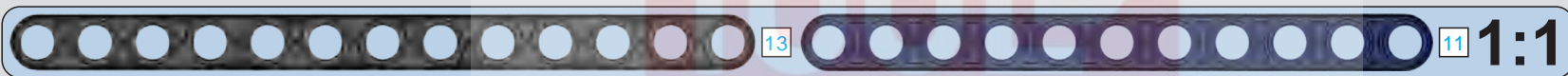
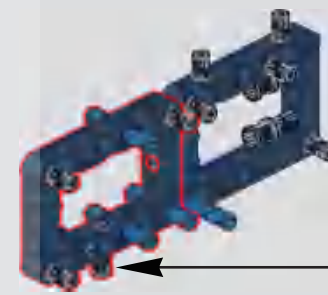

429

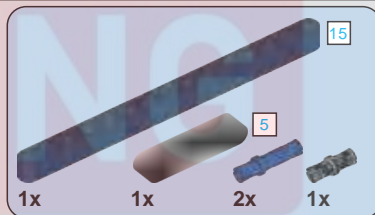

430

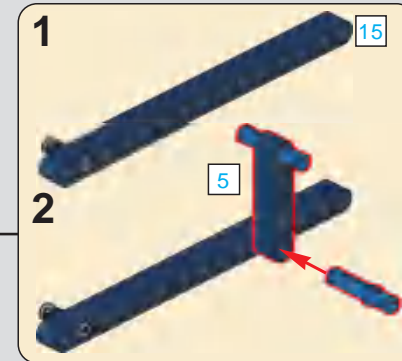
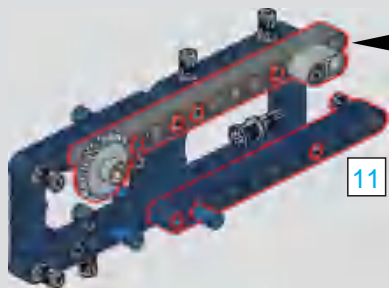

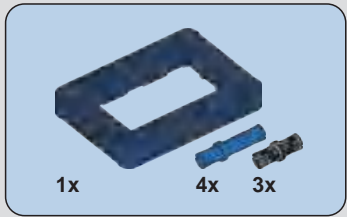

431

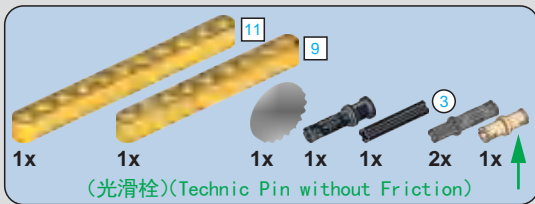
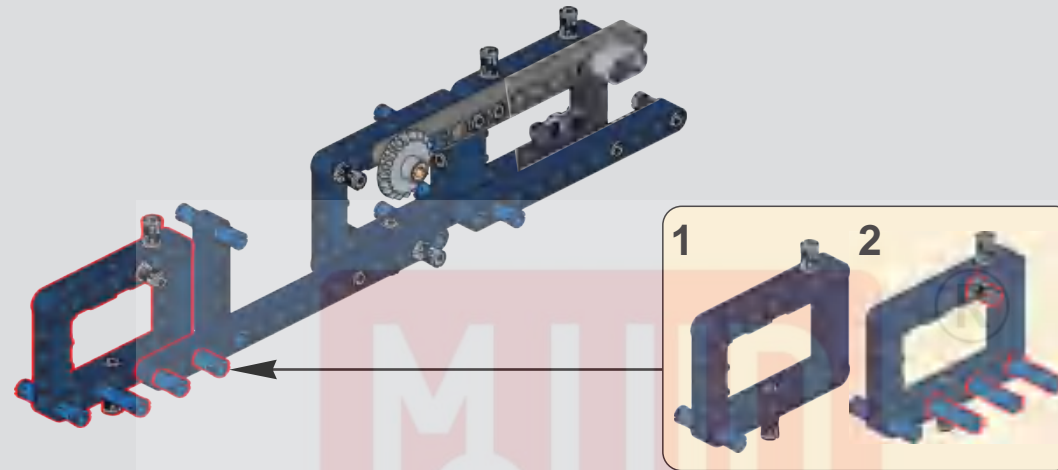

432

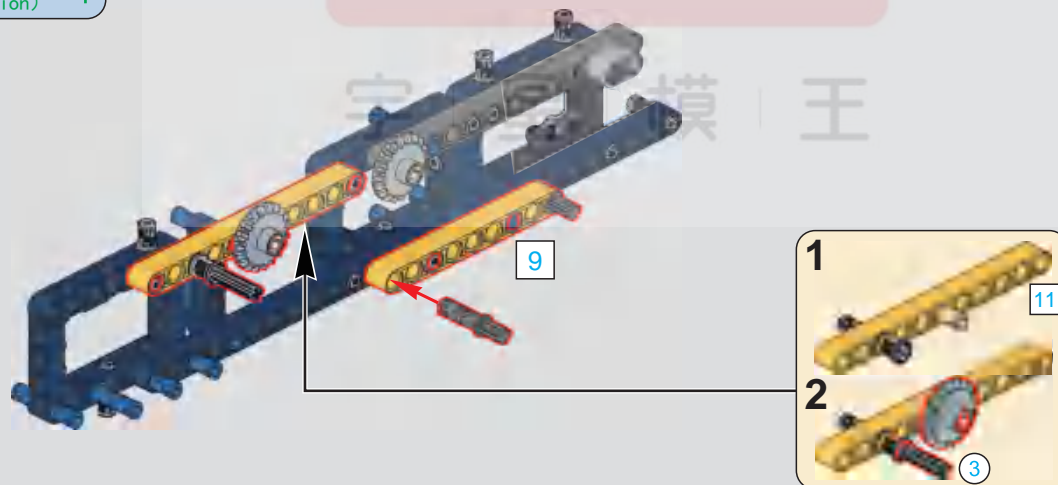

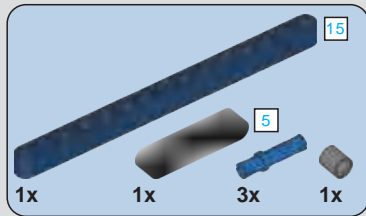

433

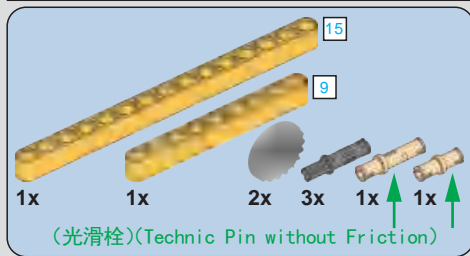
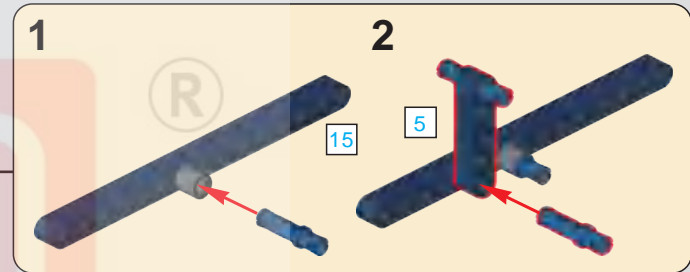
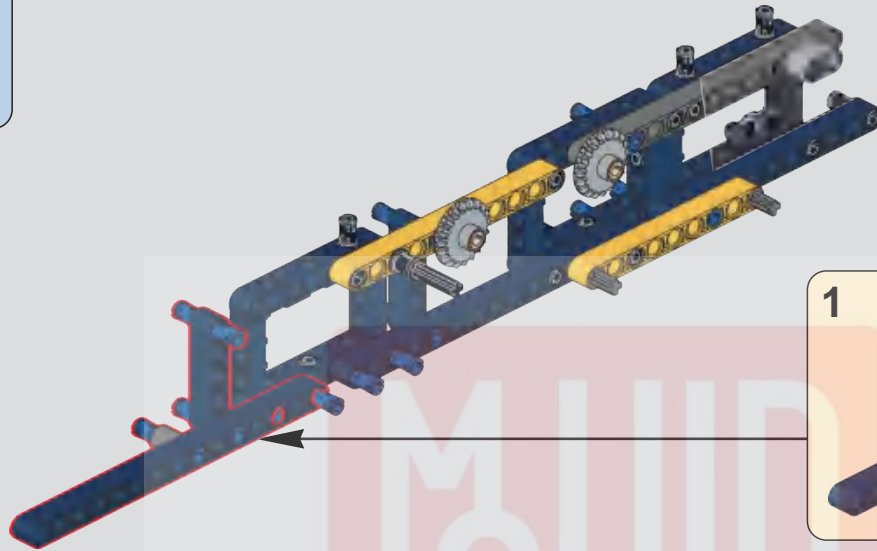

434

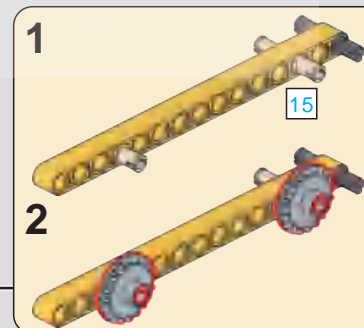

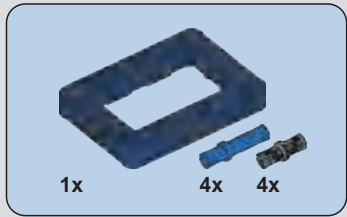

435

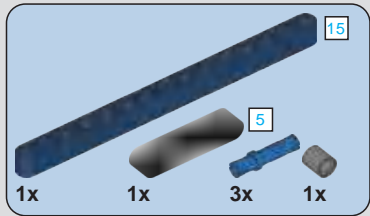

436

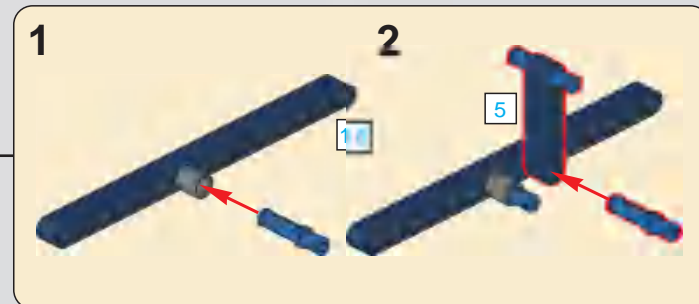
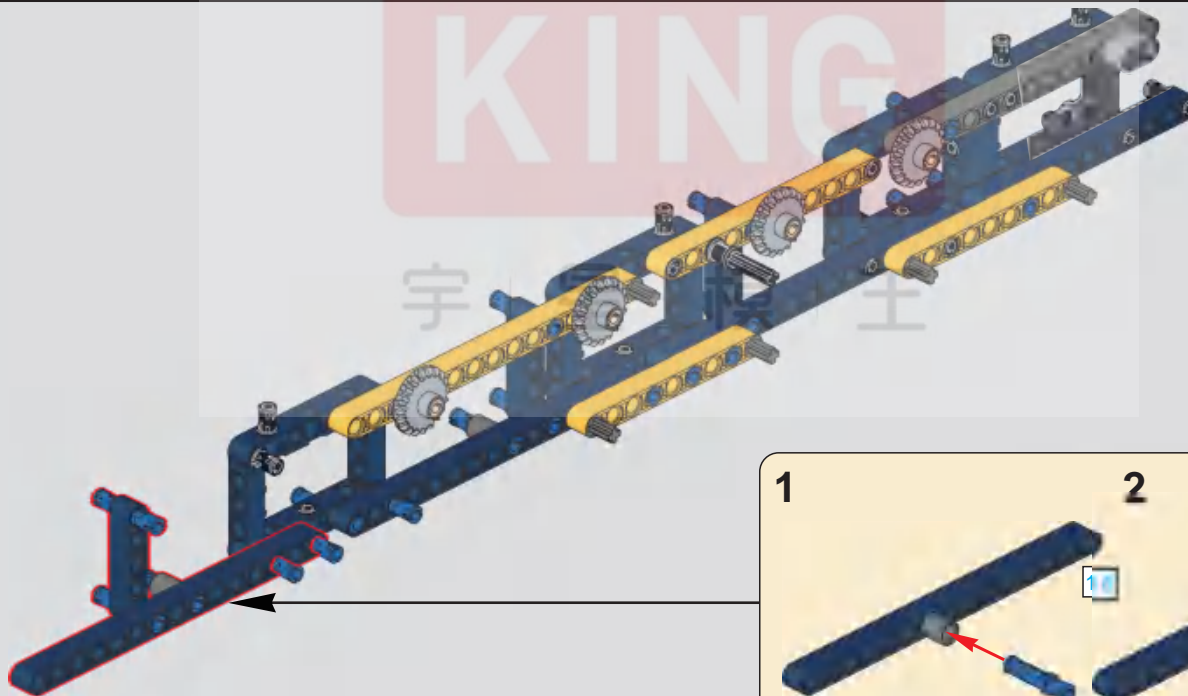

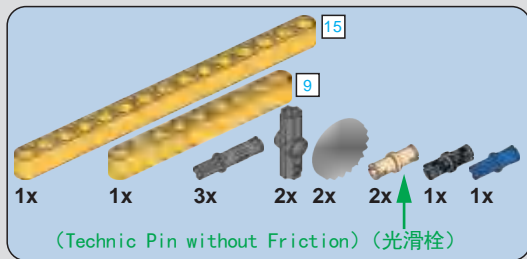

437

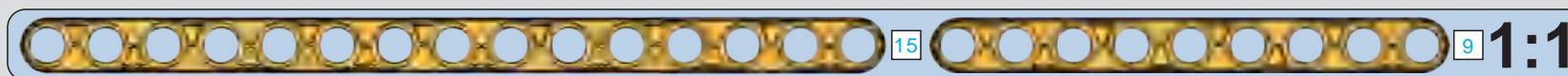
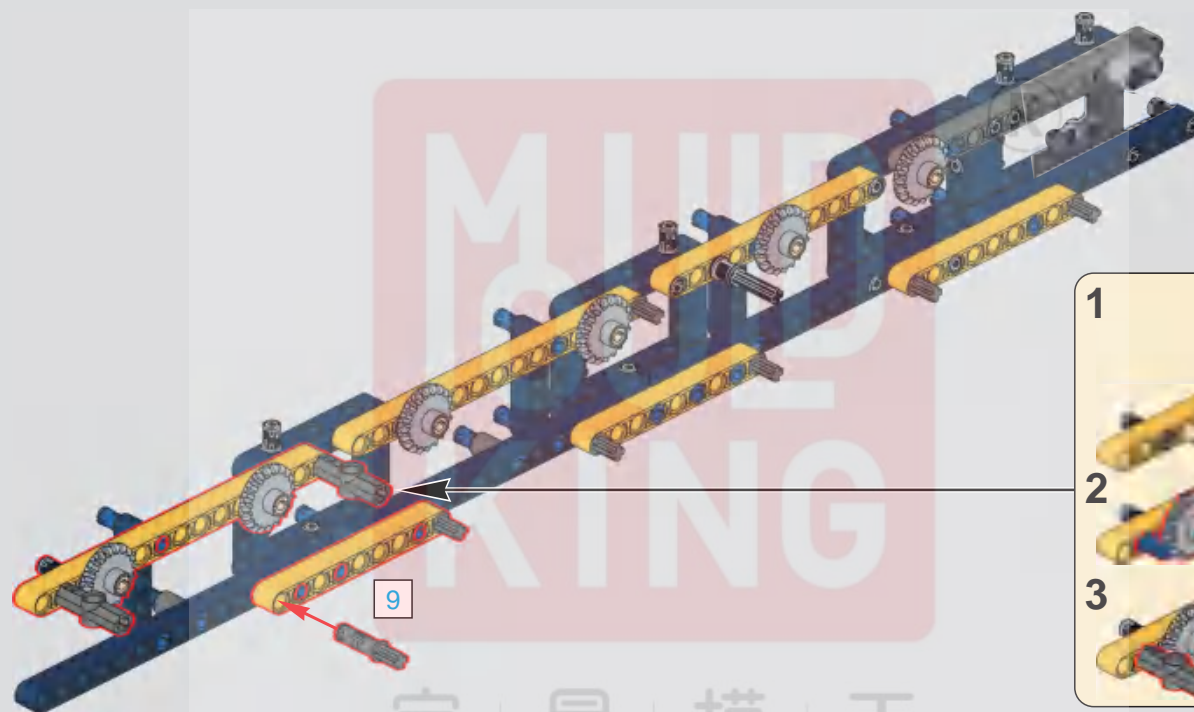

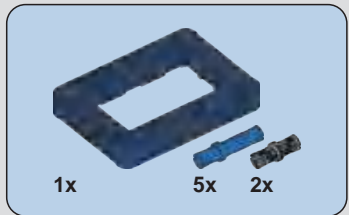

438

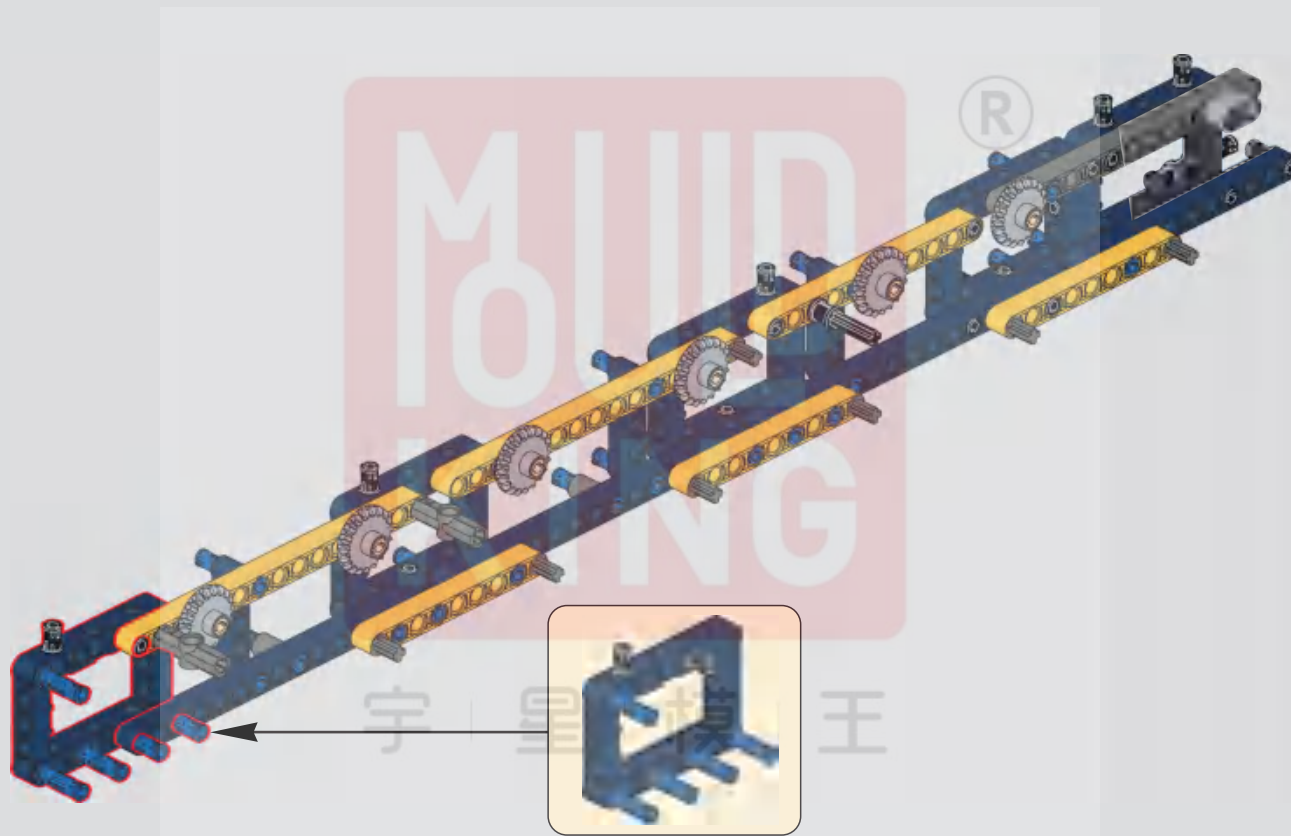

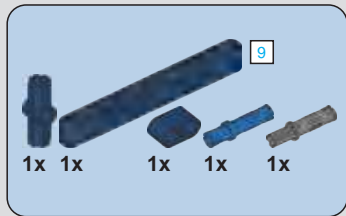

439



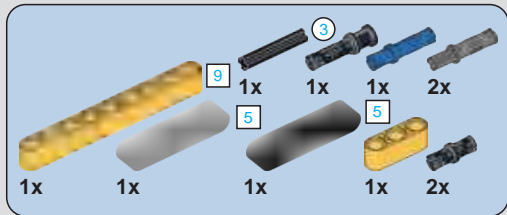

440

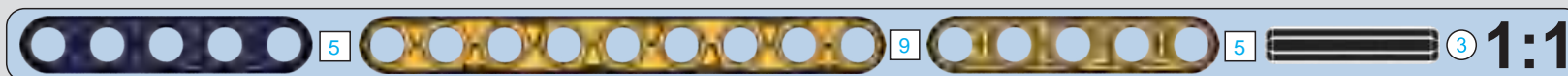
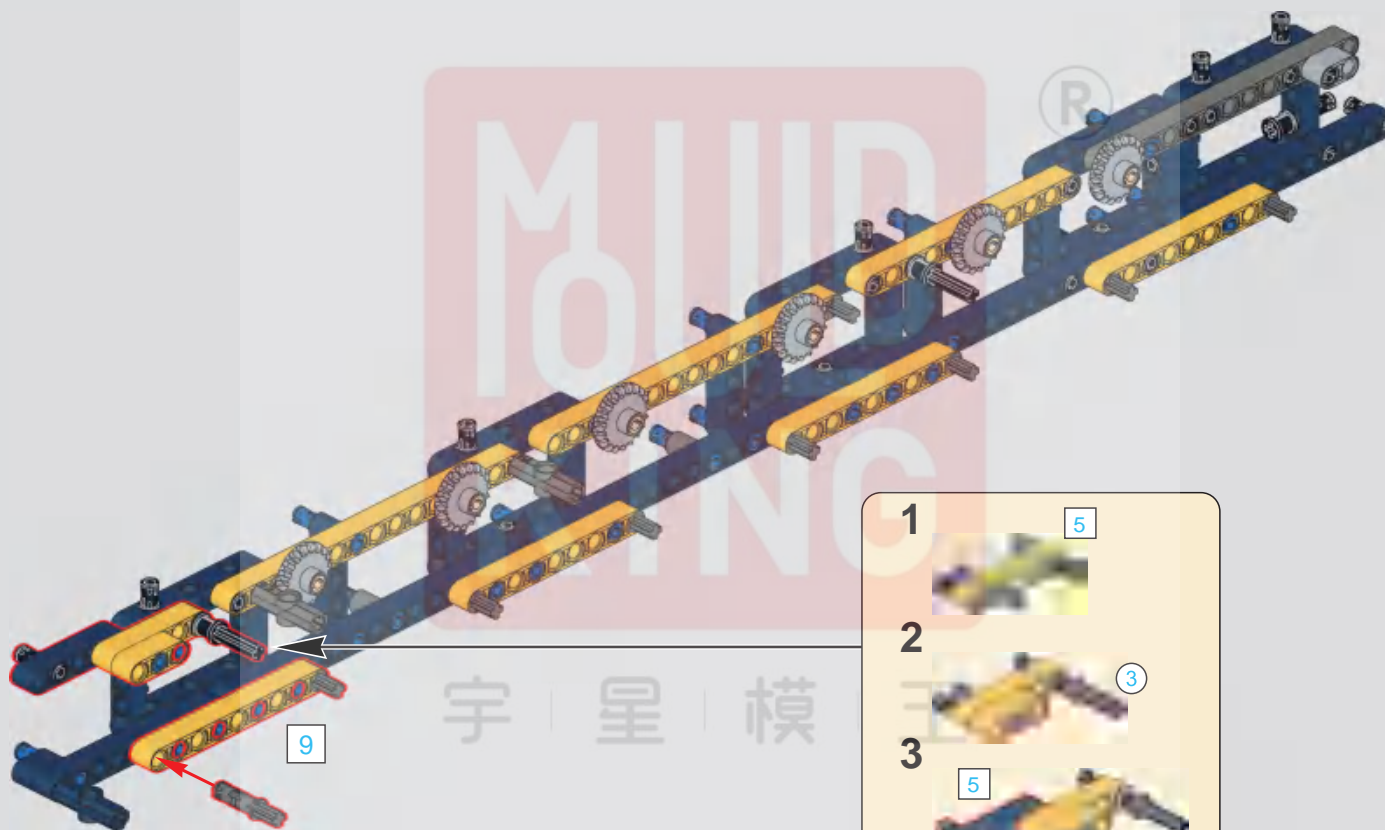

441



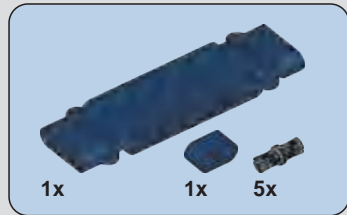
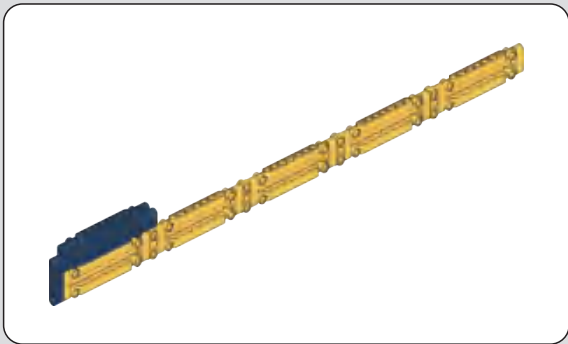

442

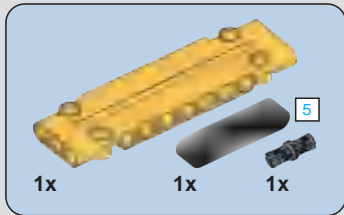

443

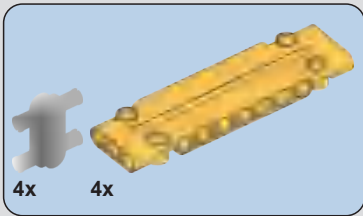

444

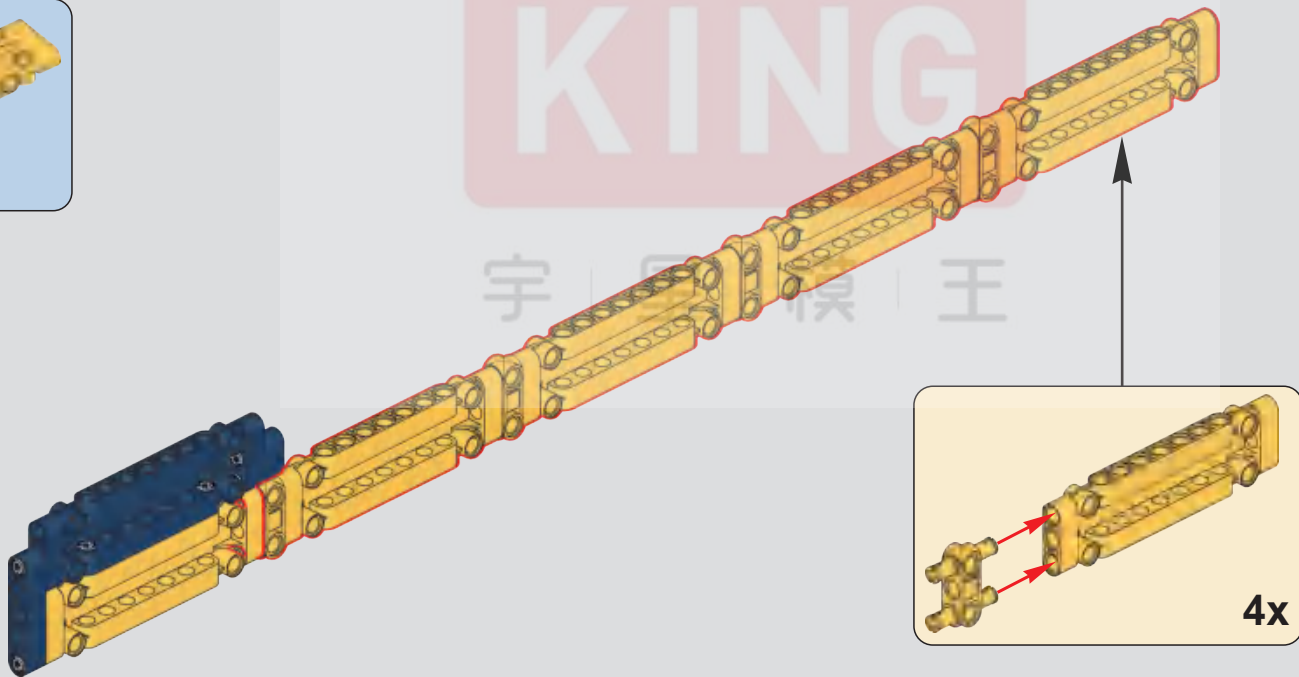

BUILD
KING
宇 模 王

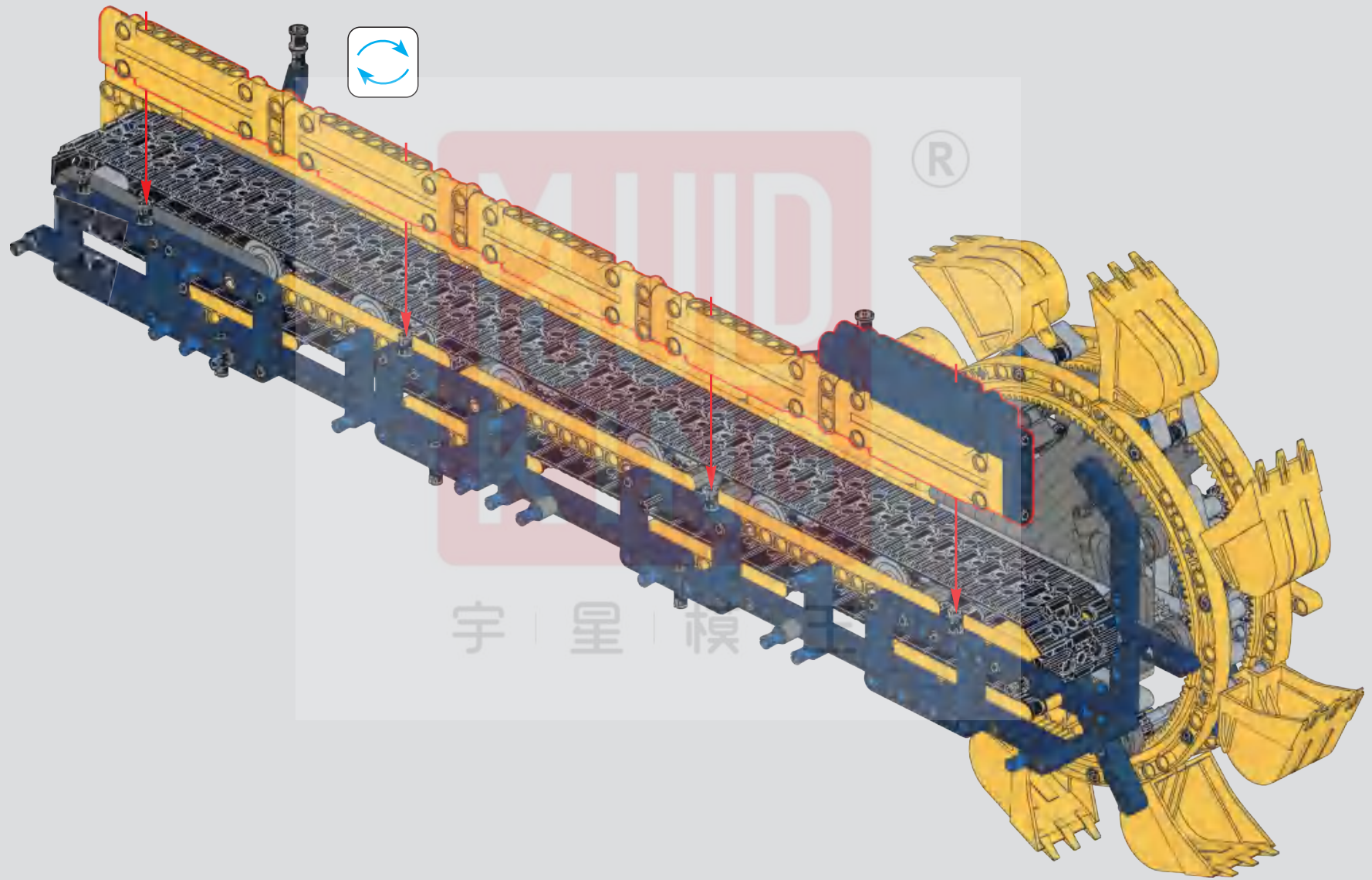

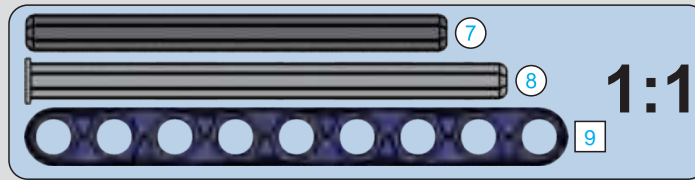
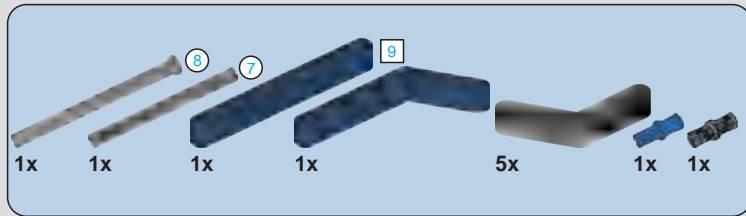

446

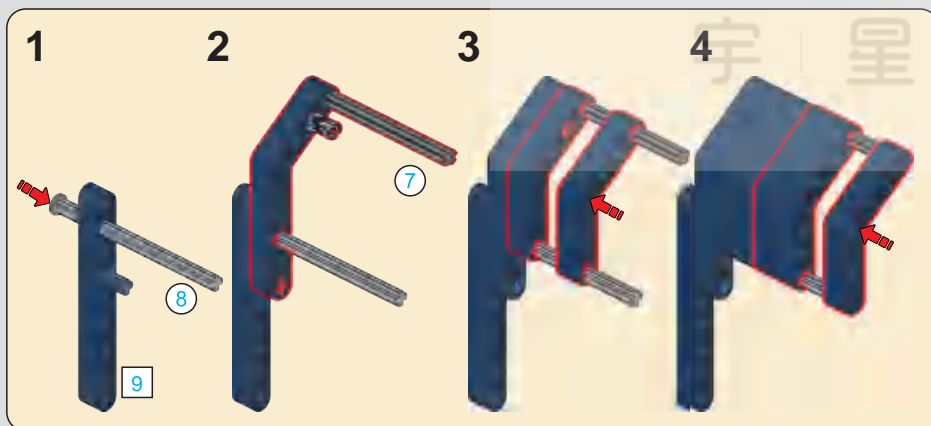
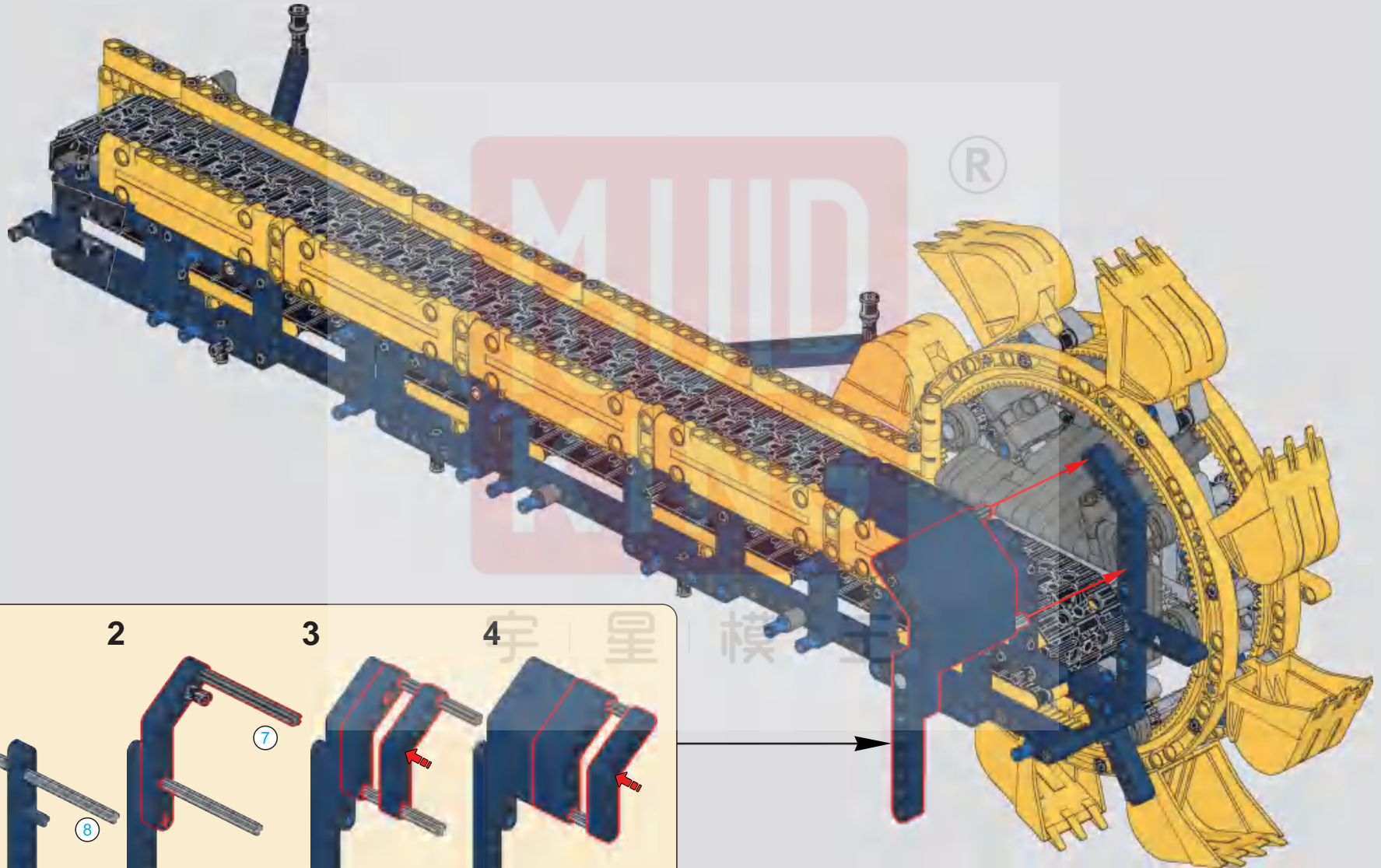

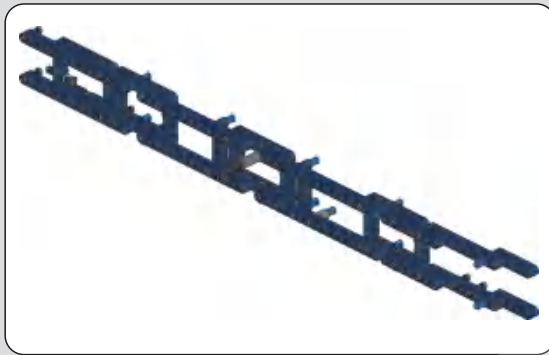

447

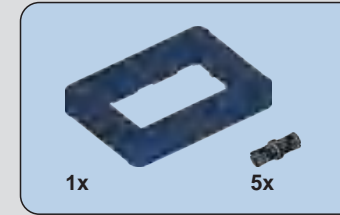

448

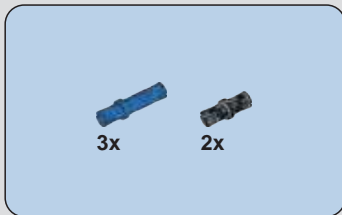
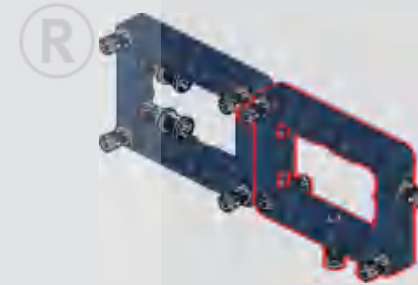

449



450

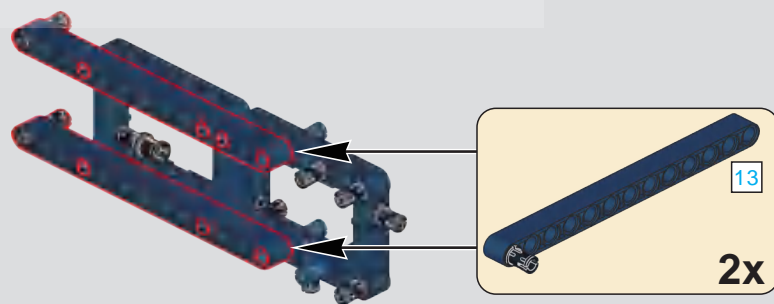
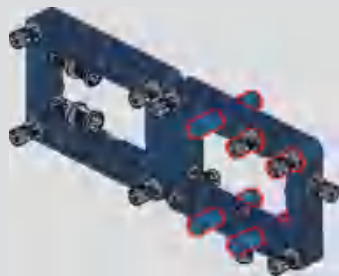

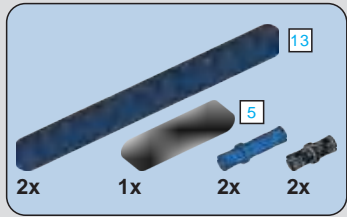

451

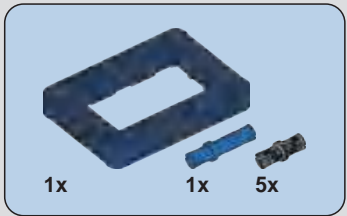
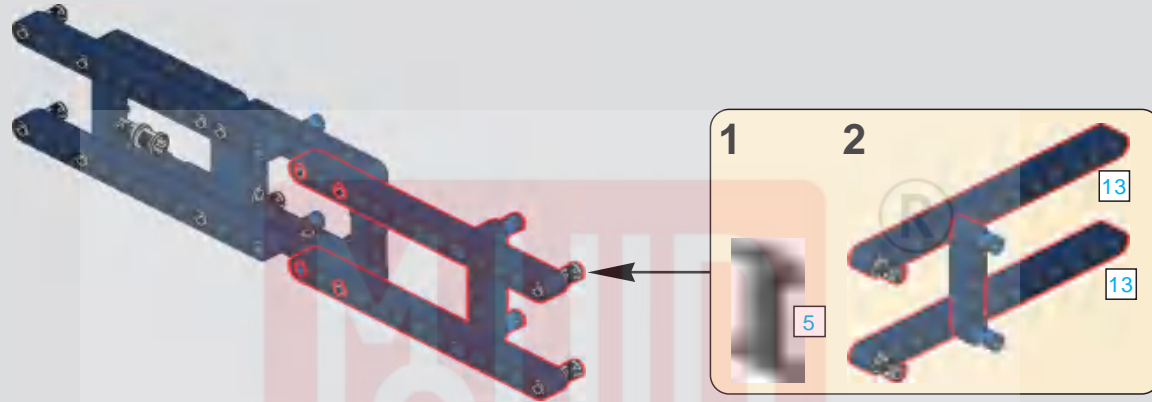

452

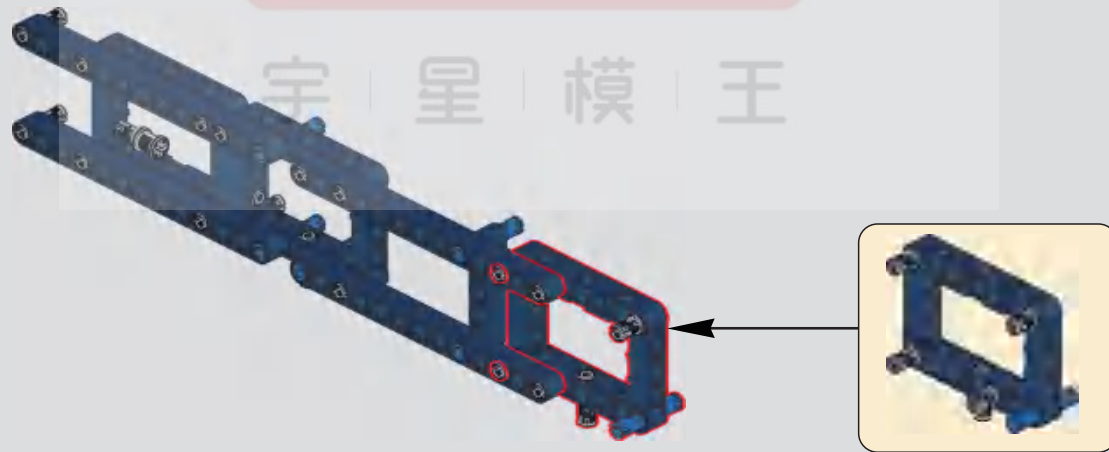

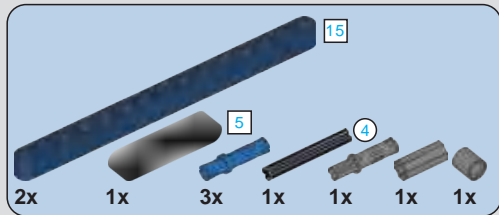

453

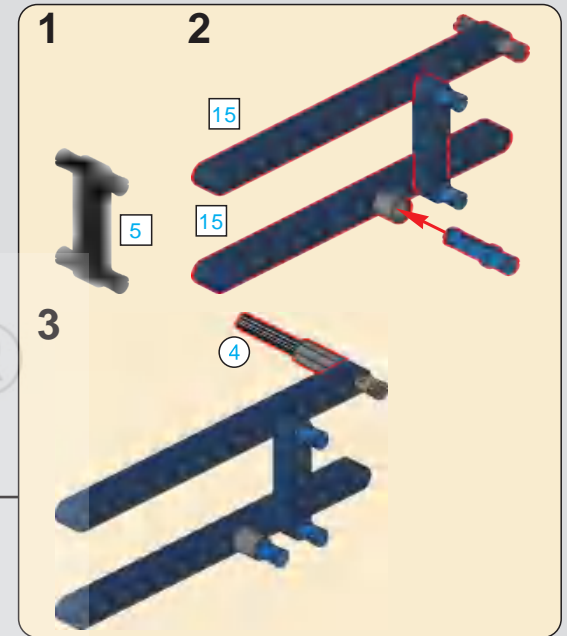
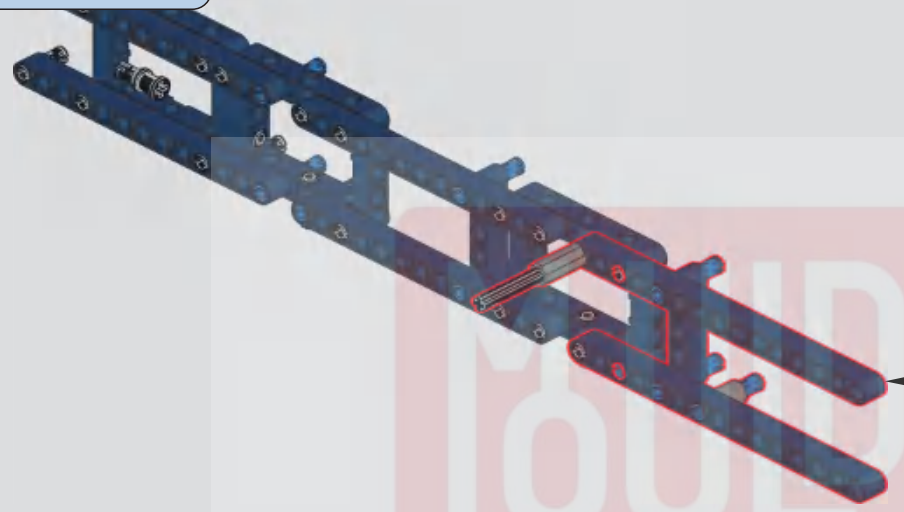

454

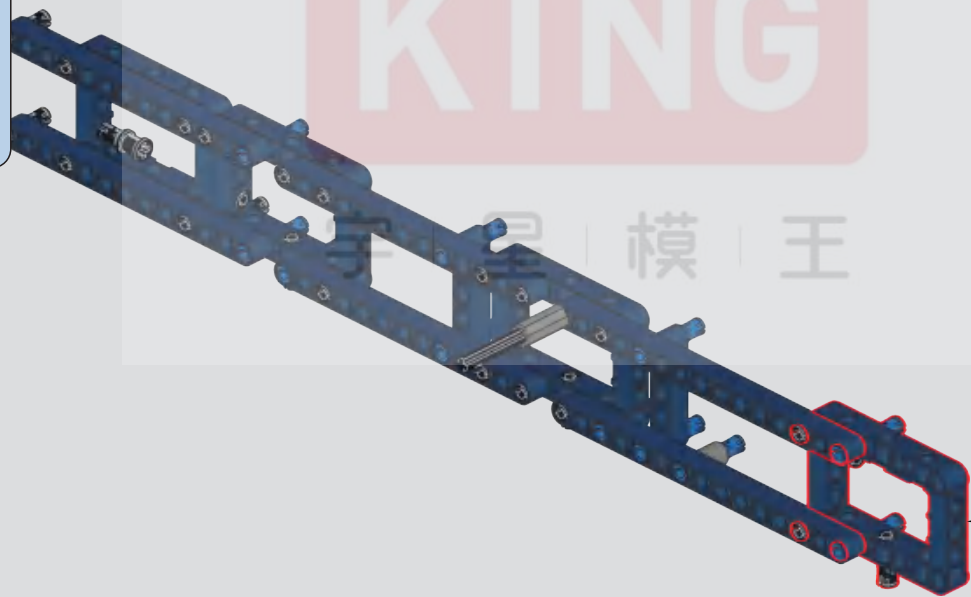



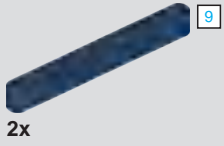

2x

456





457



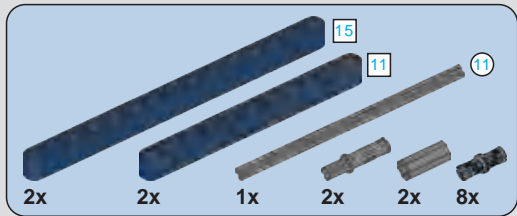

458

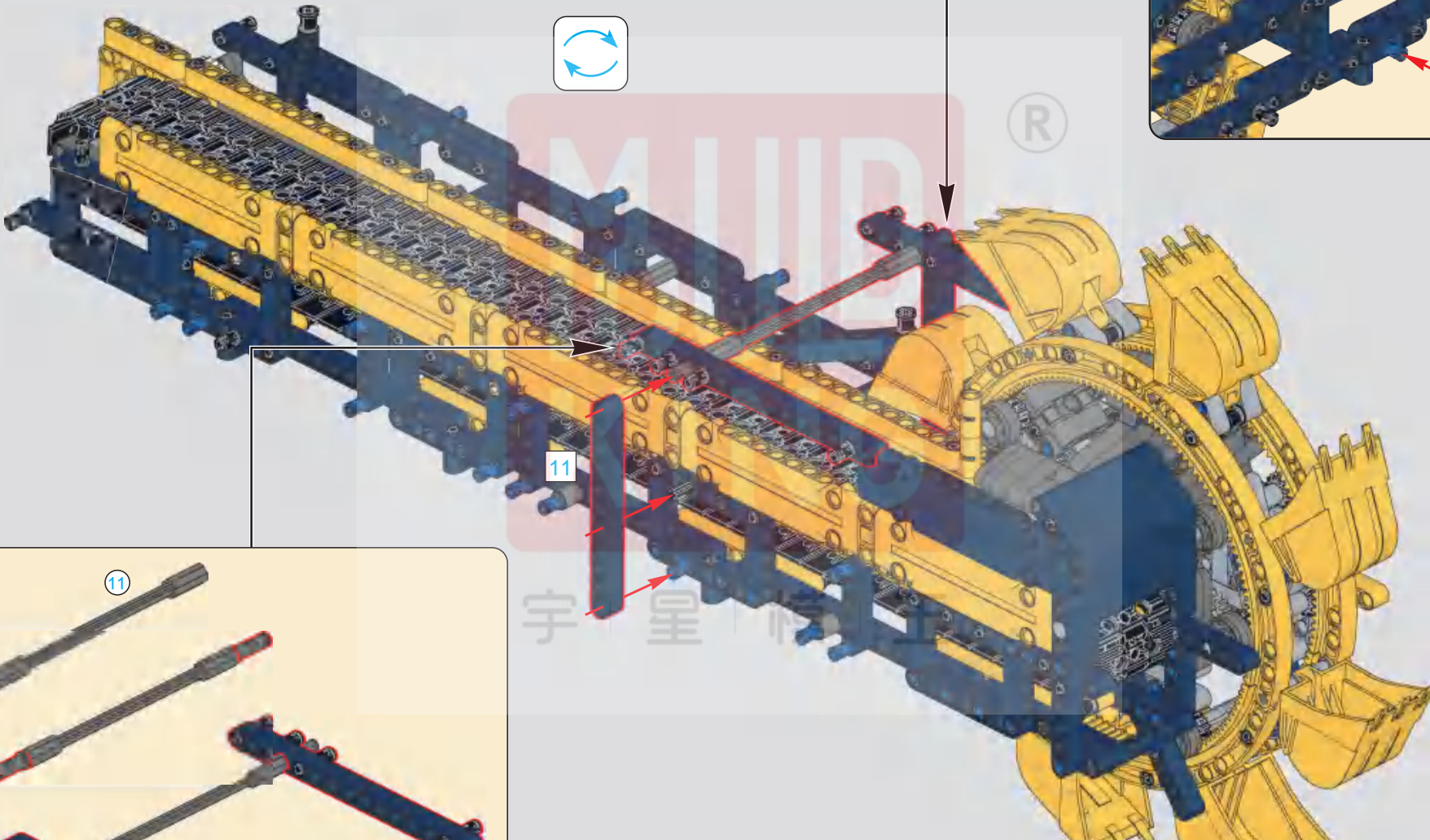
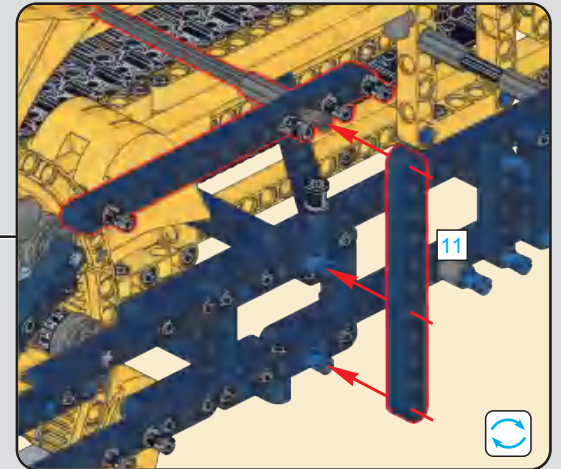



459

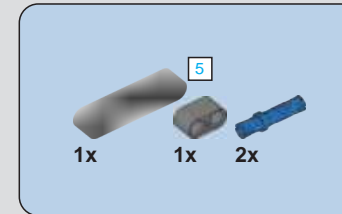

460

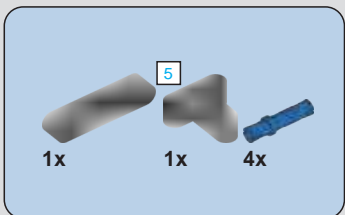
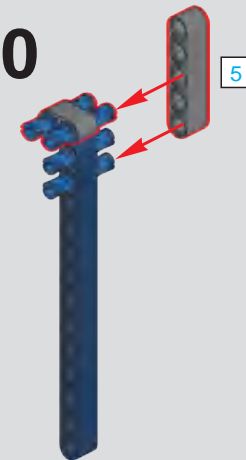

461

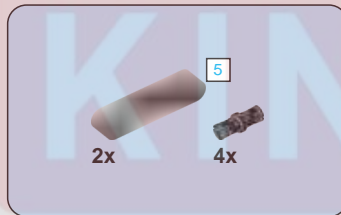
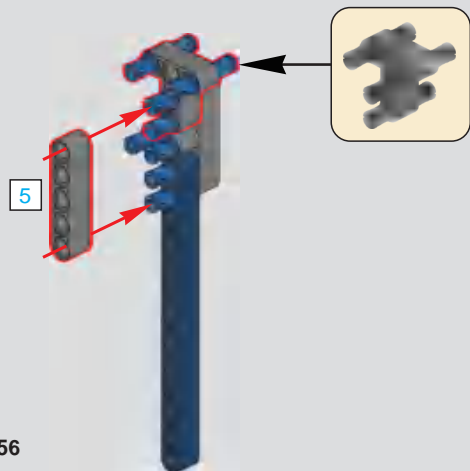

462

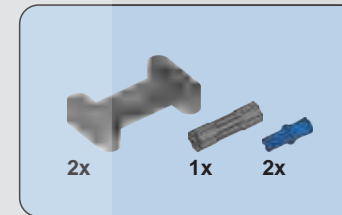

463

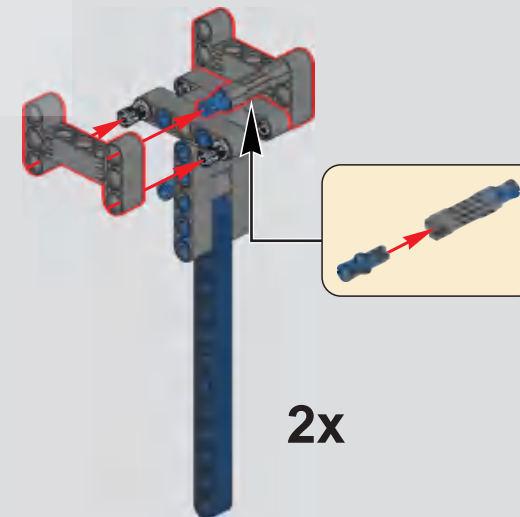

464

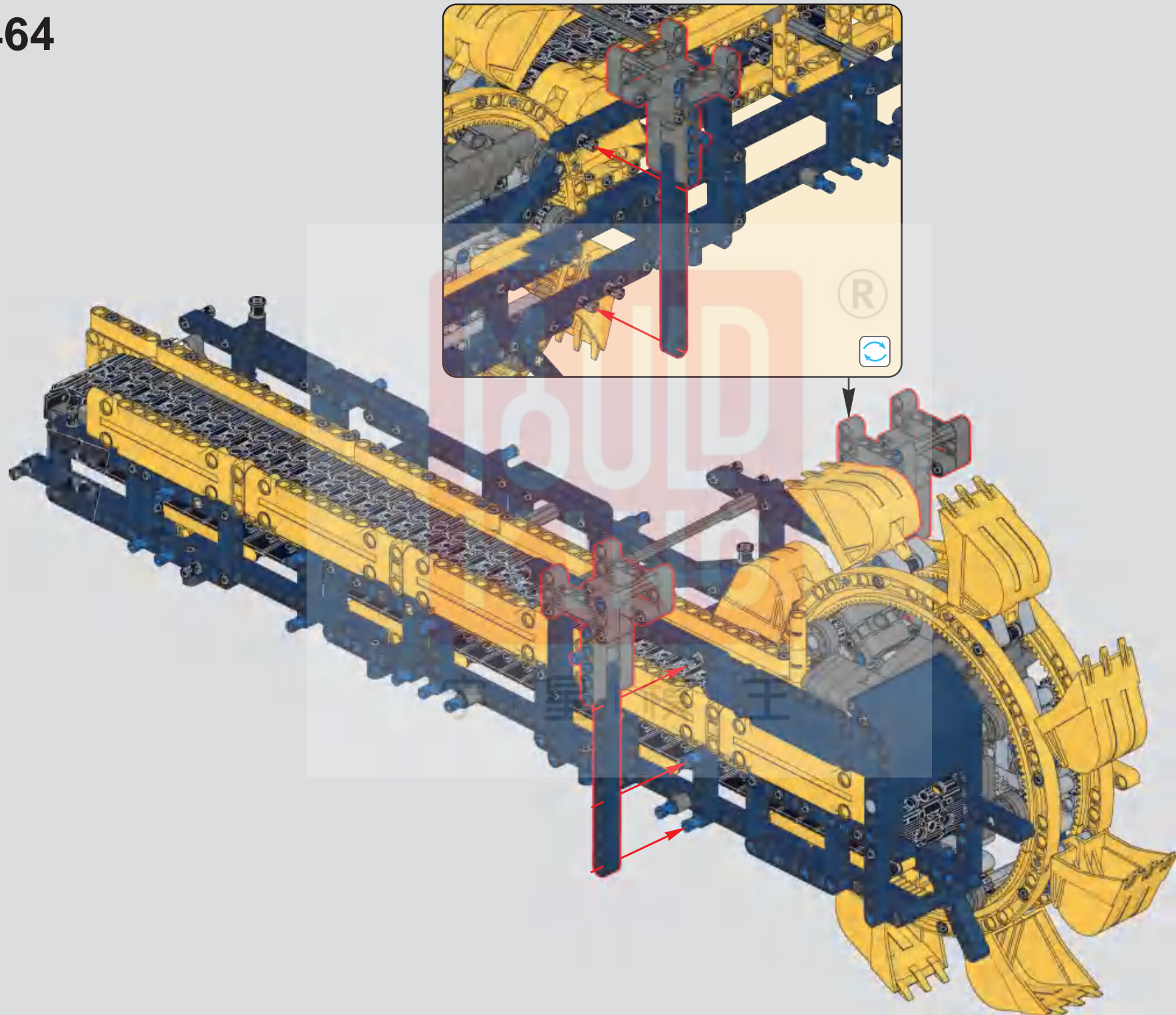



465

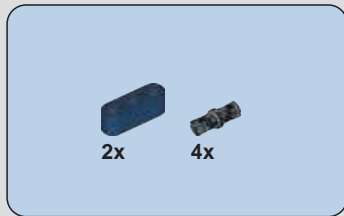

466

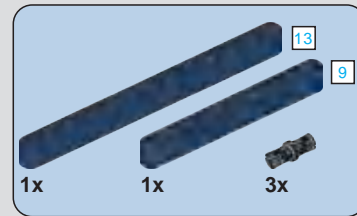

467

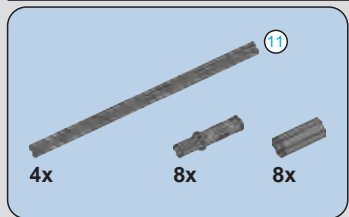
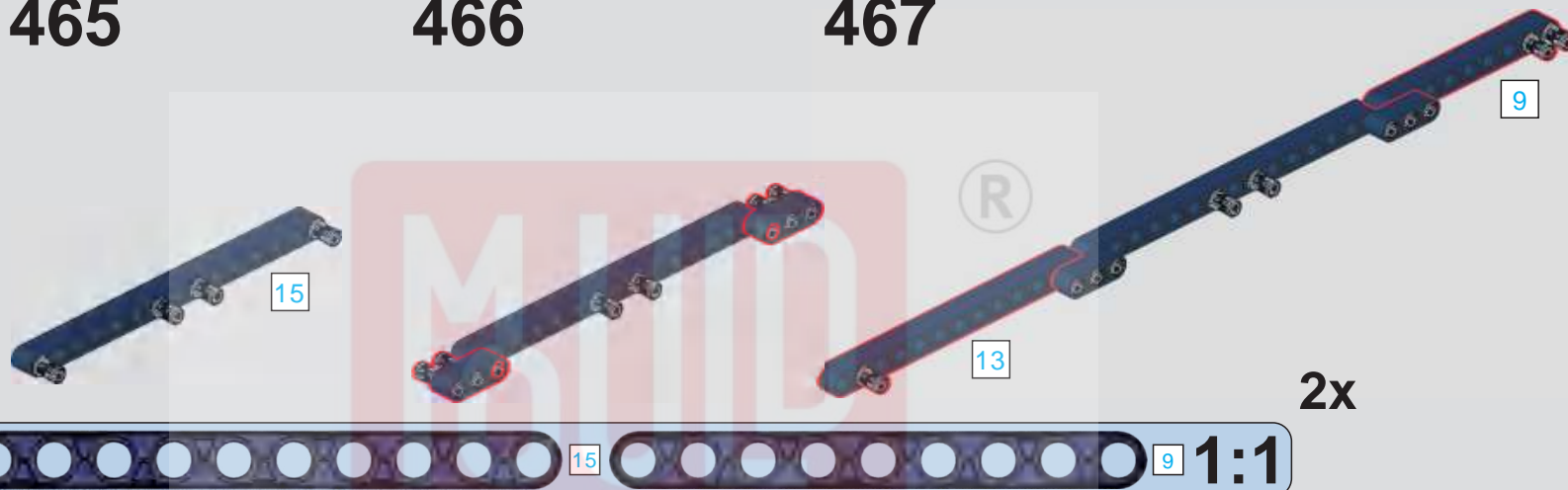

468

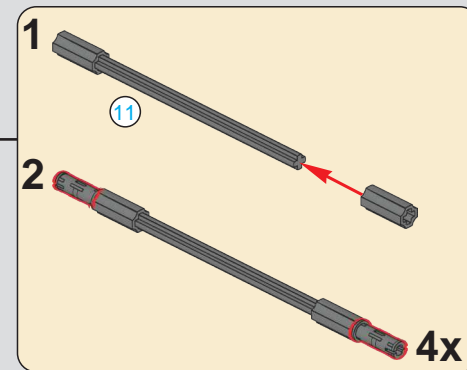

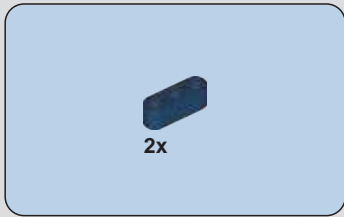

469

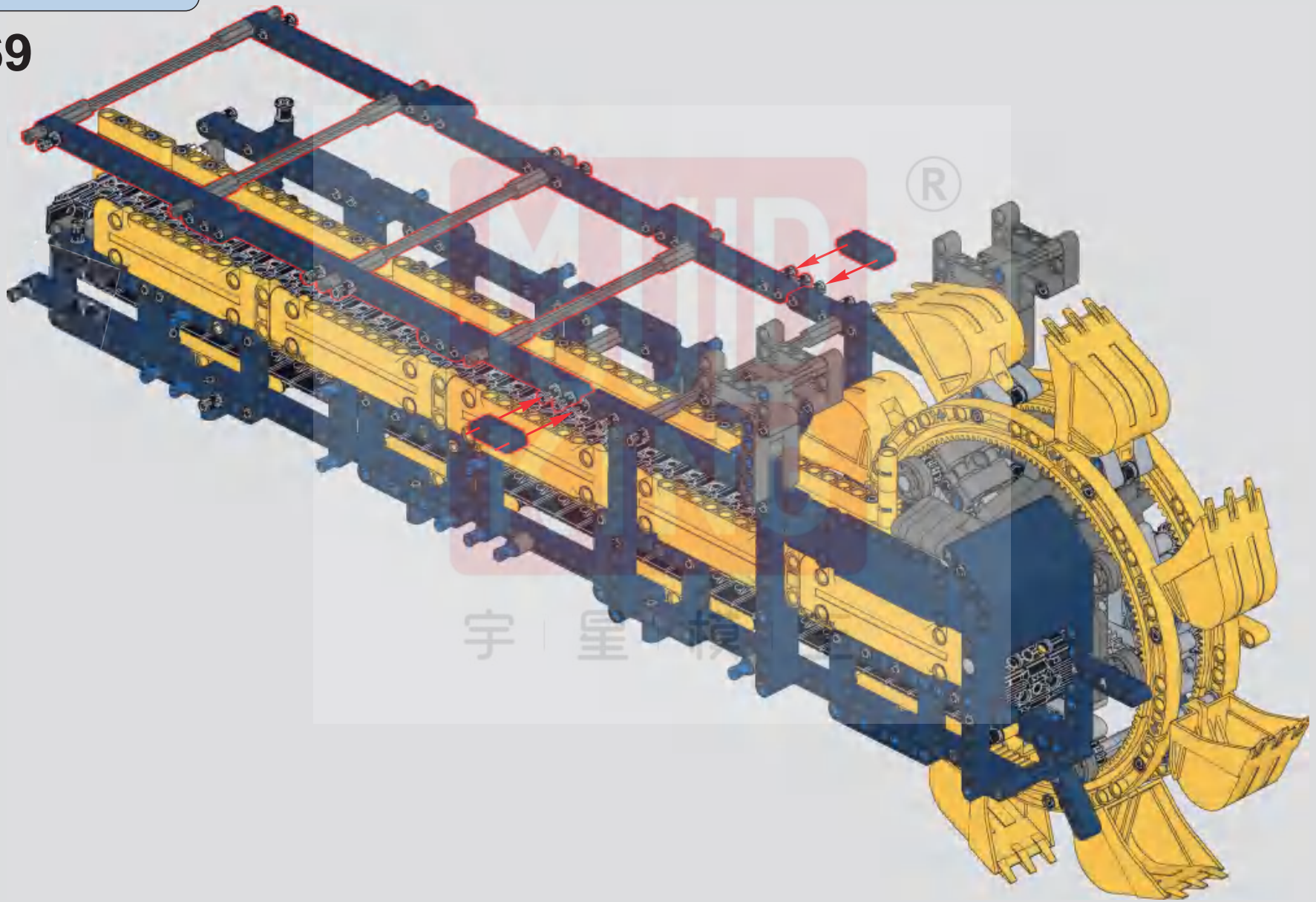



470

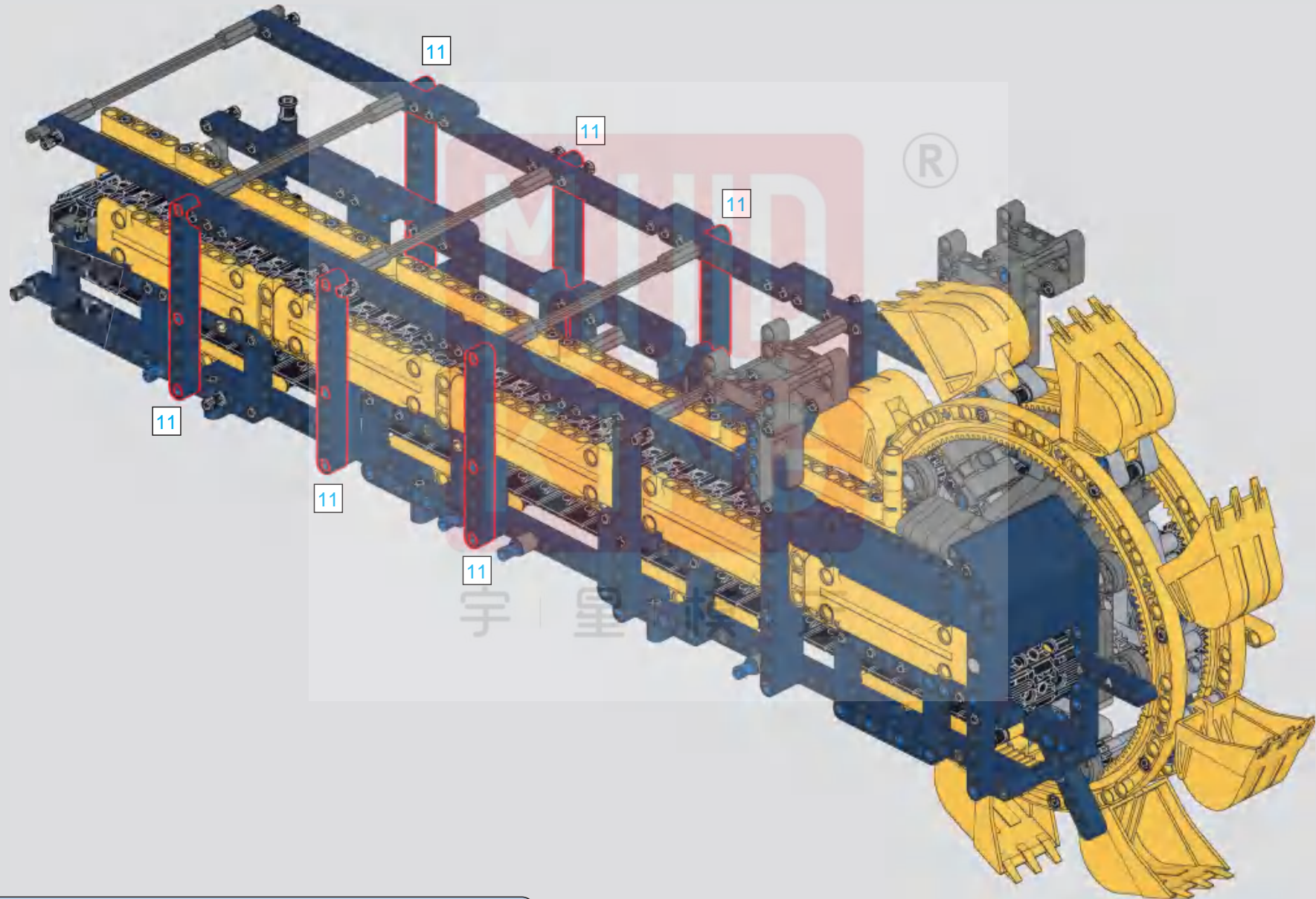

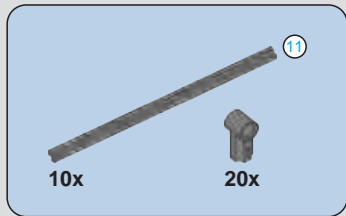

471

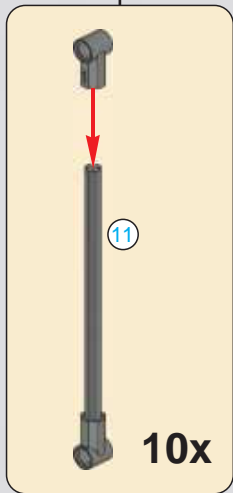
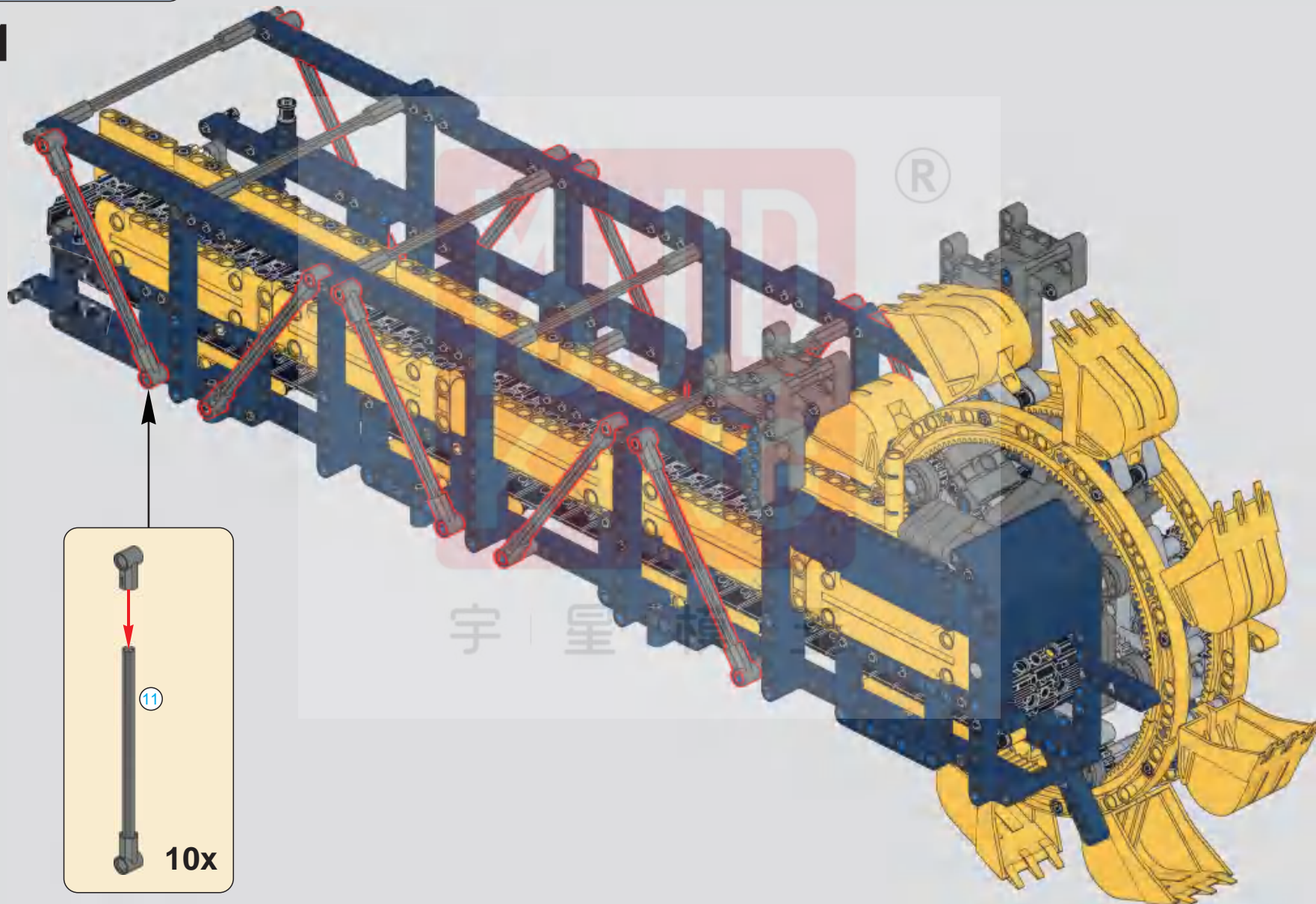

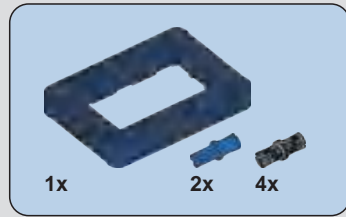

472

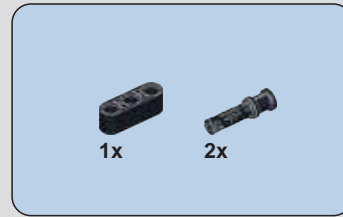

473

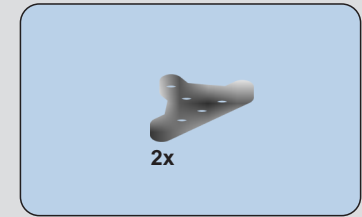

474

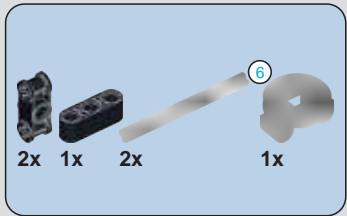
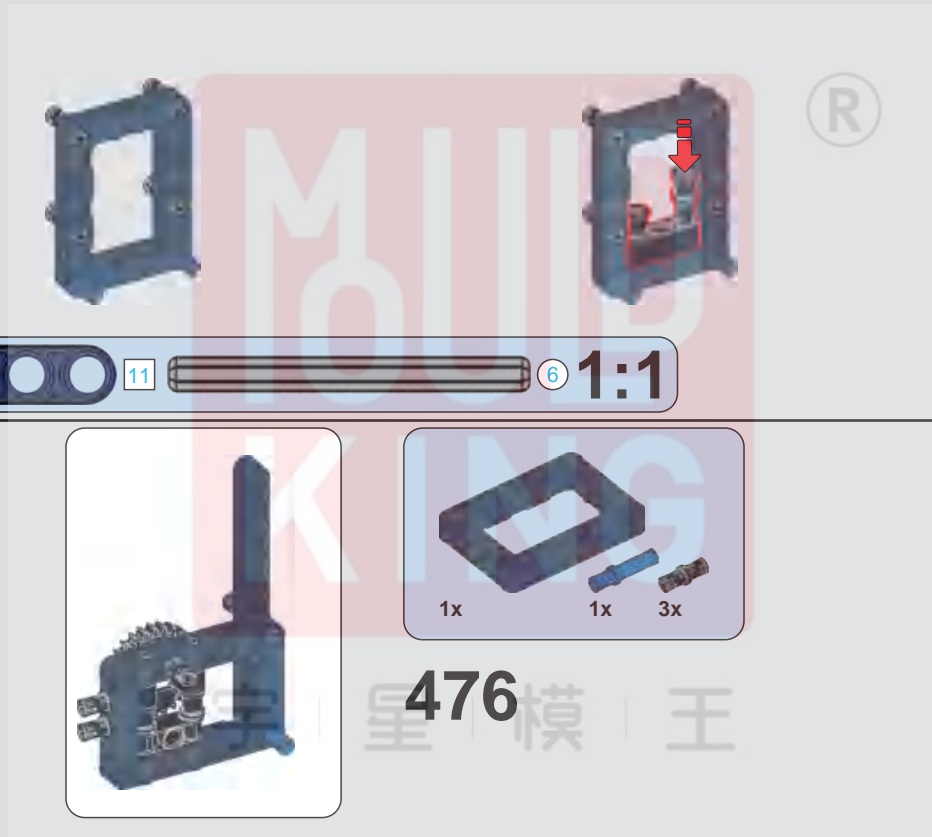

475

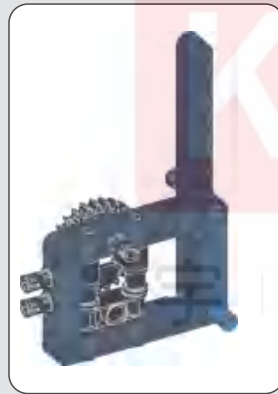

476

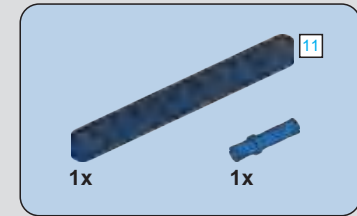
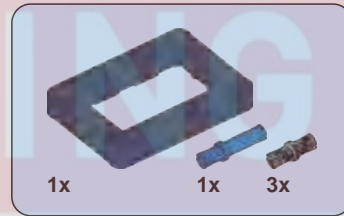

477

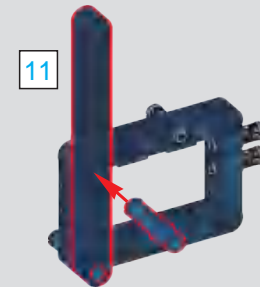
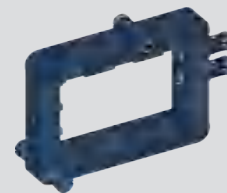
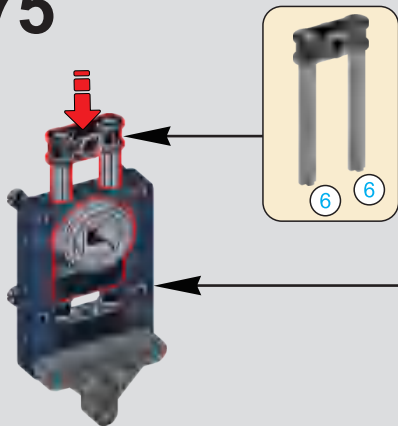

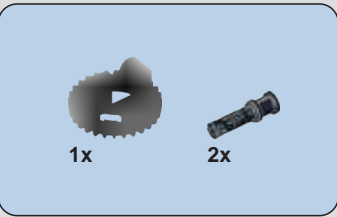

478

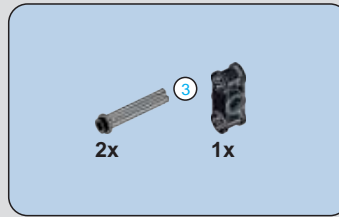
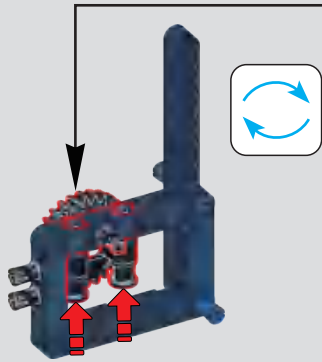

479

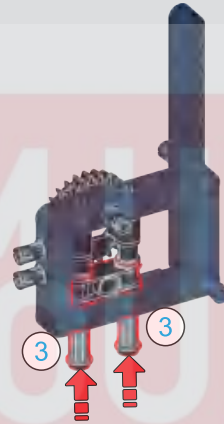

480

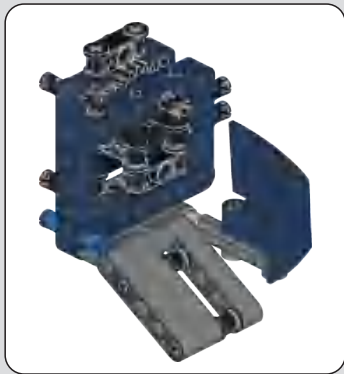
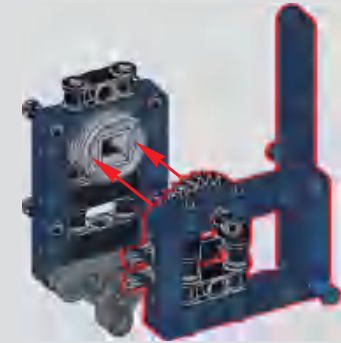

481



482

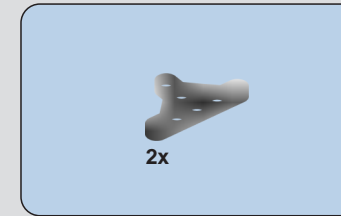

483

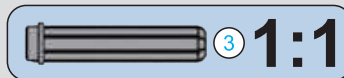

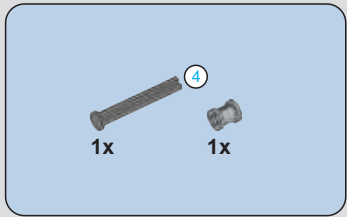

484

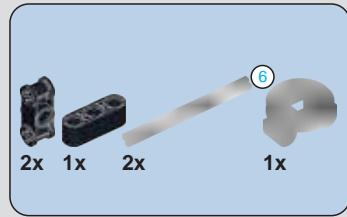

485

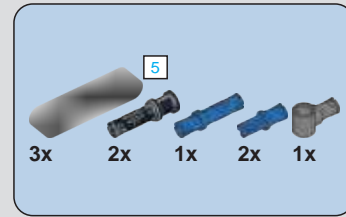
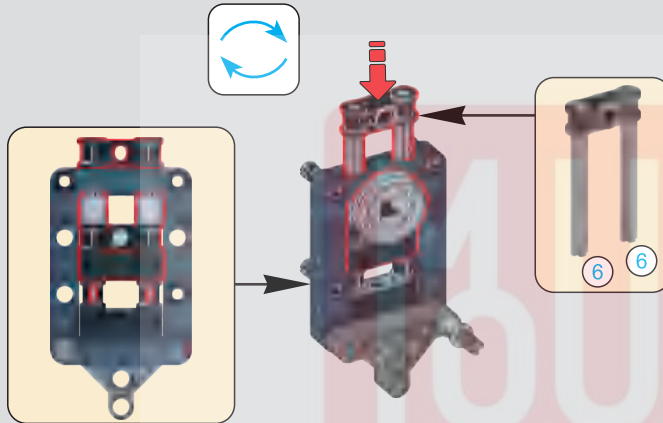

486

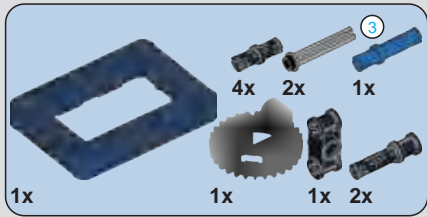
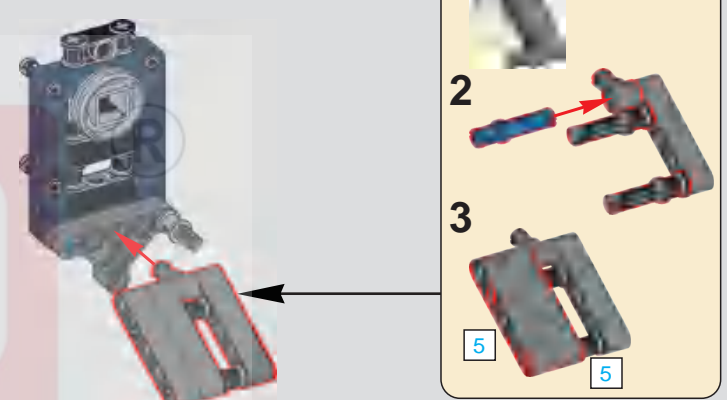

487

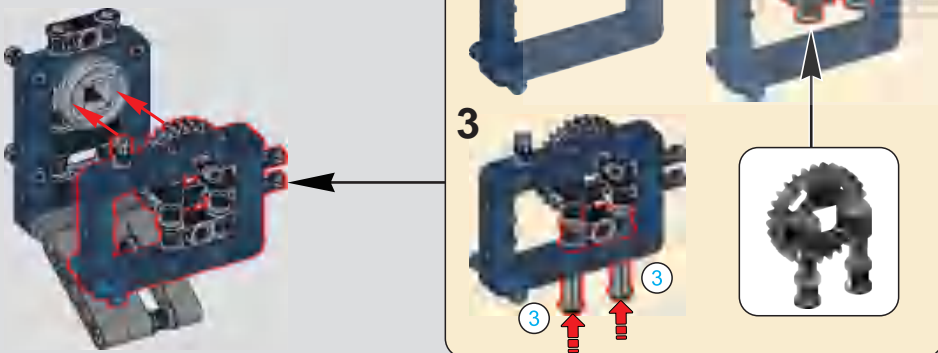

488

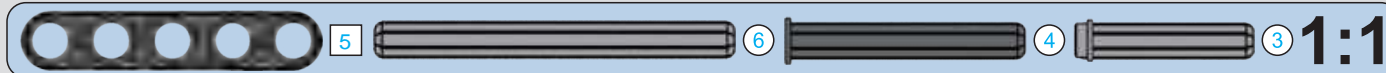
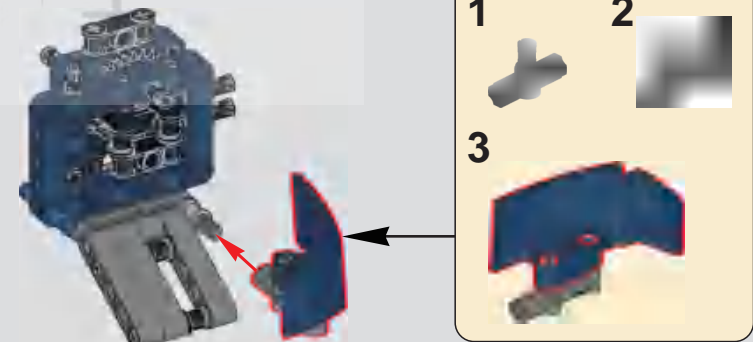

489



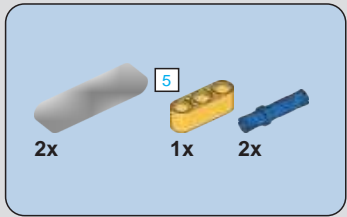

490

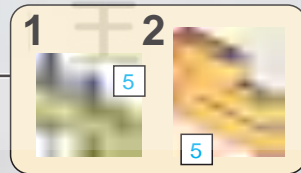

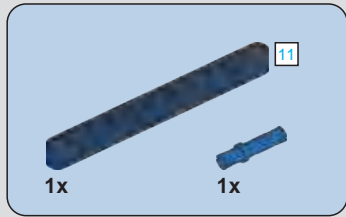

491



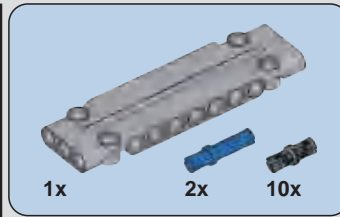

492

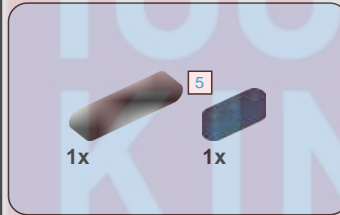

493

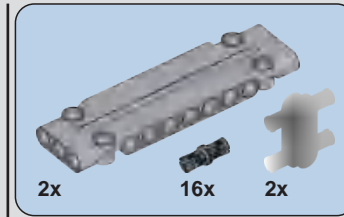

494

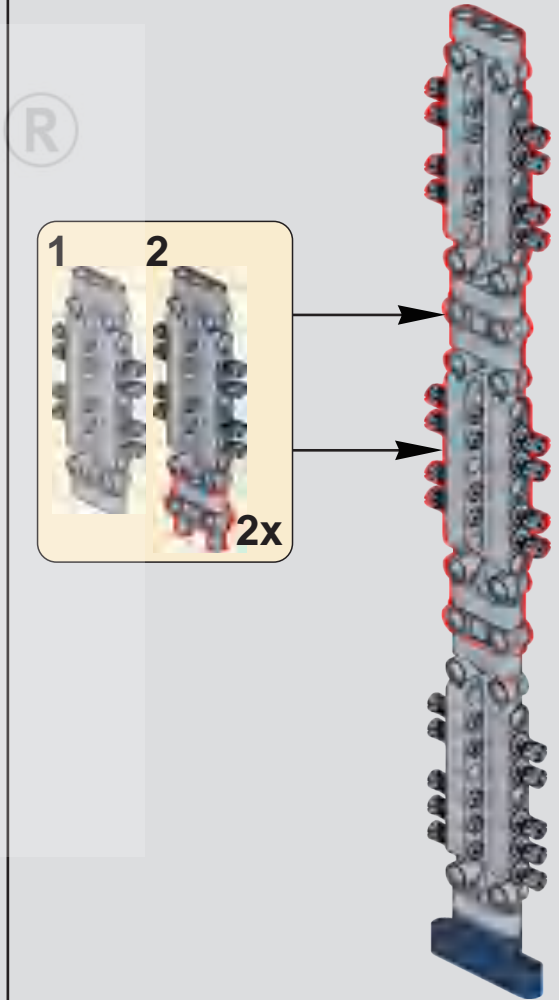

MOULD KING
宇 | 模 | 王

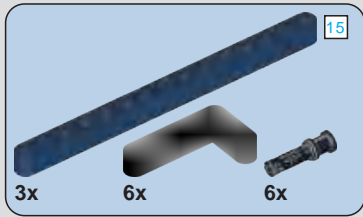

497

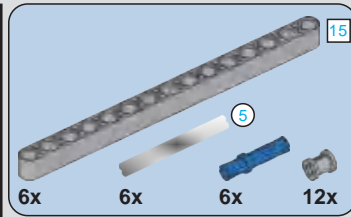
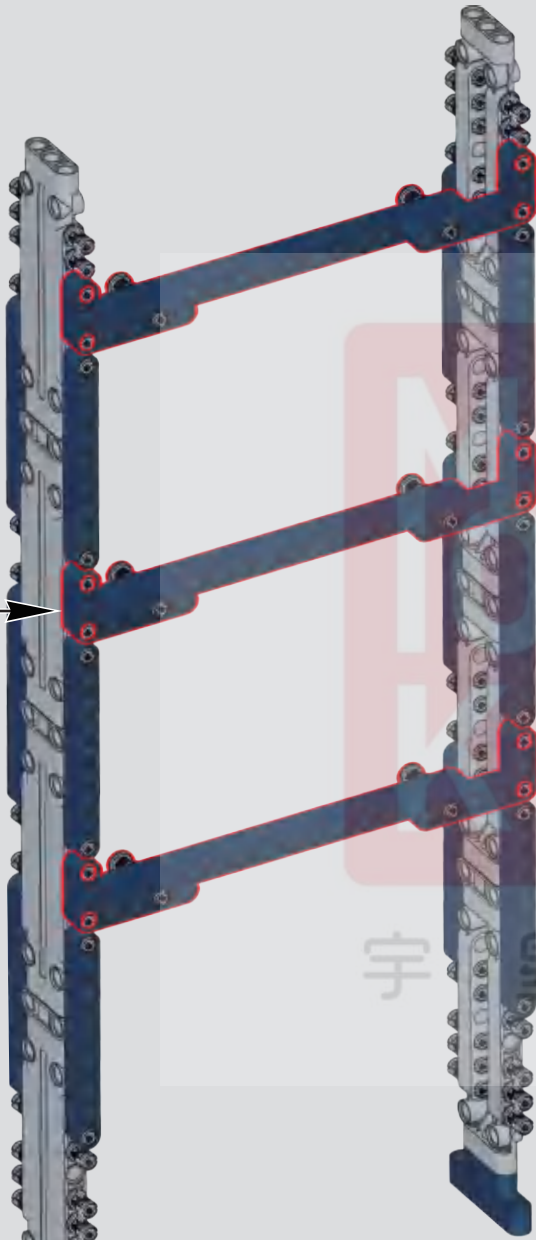
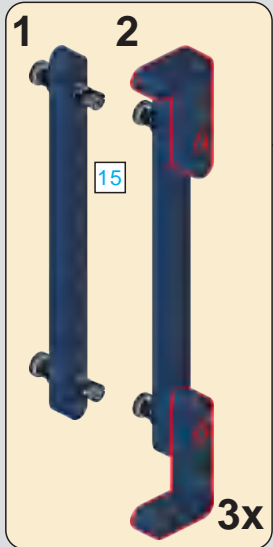

498

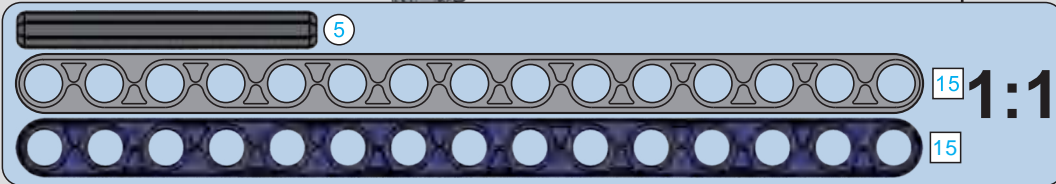
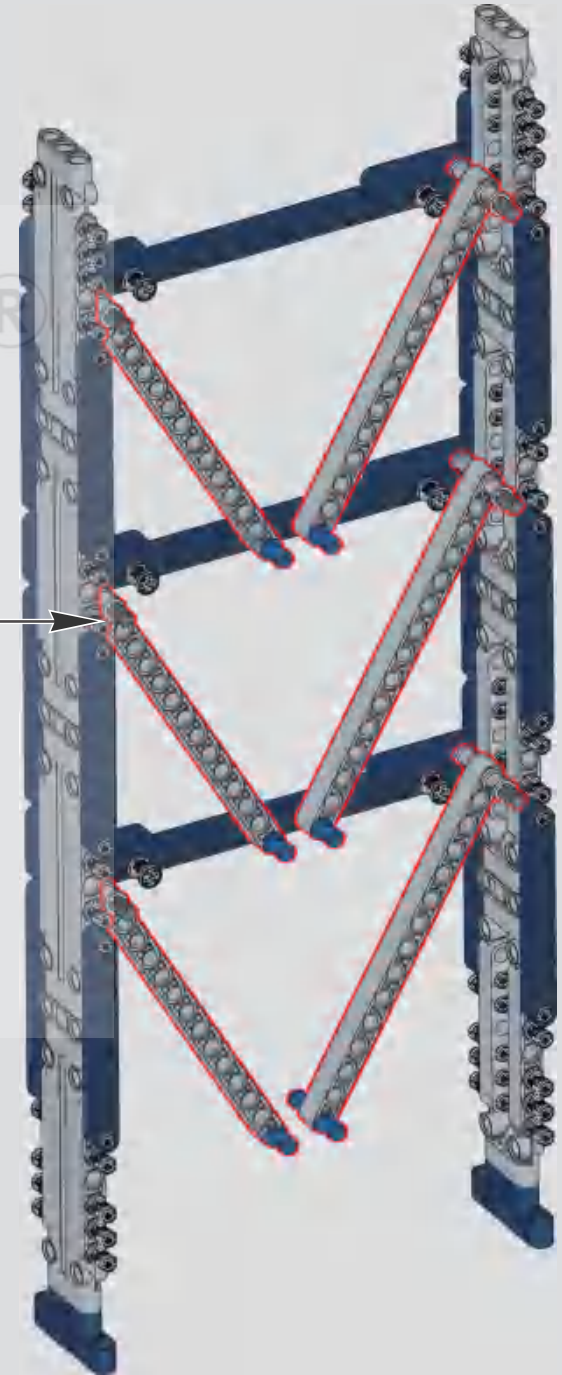
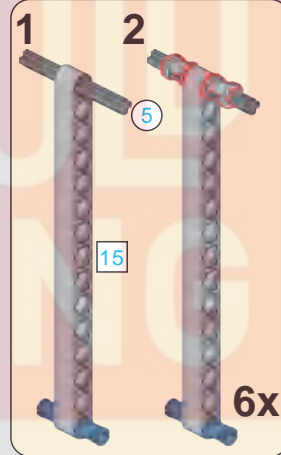

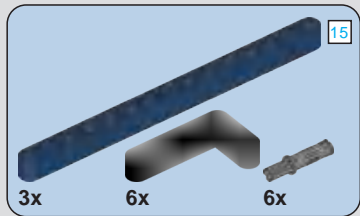

499

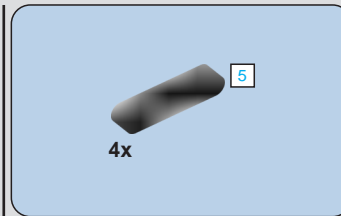
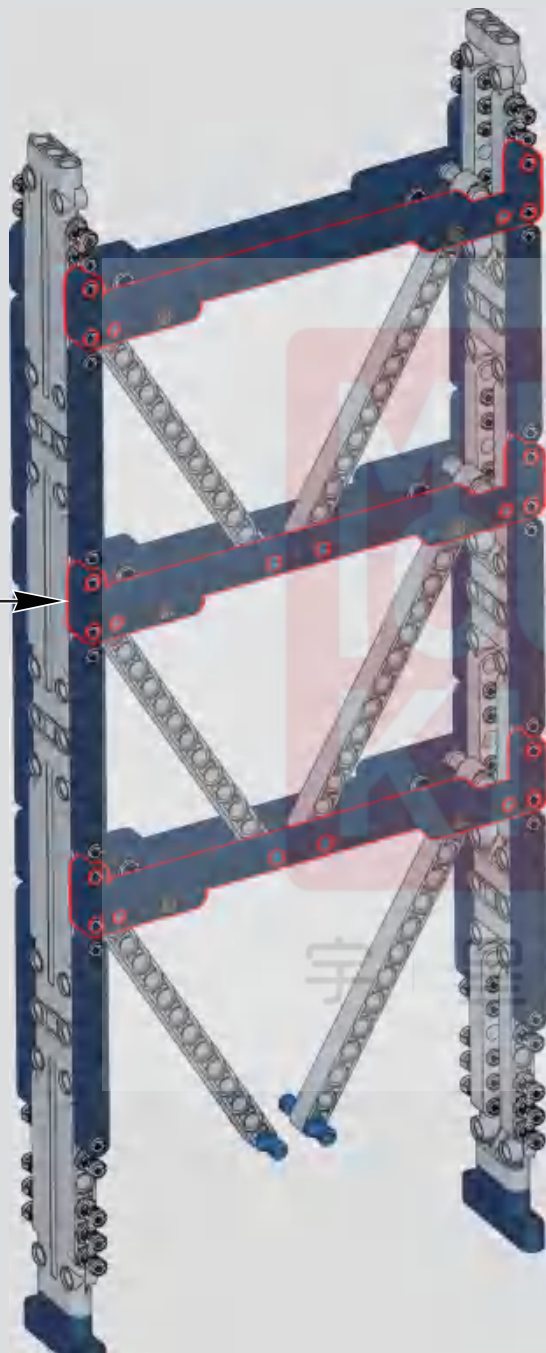
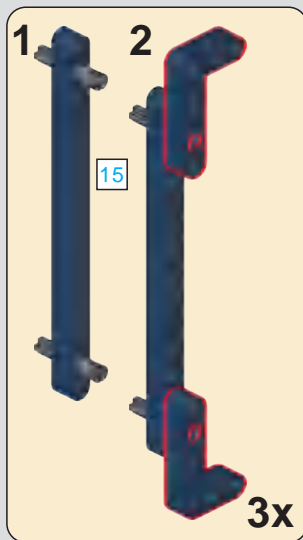

500



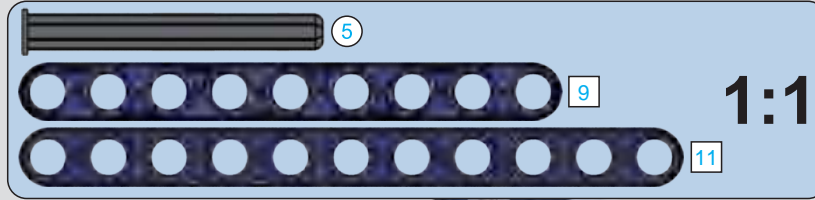
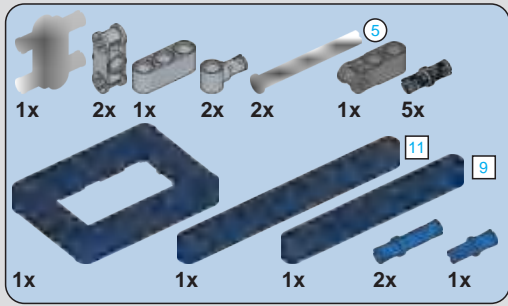

501

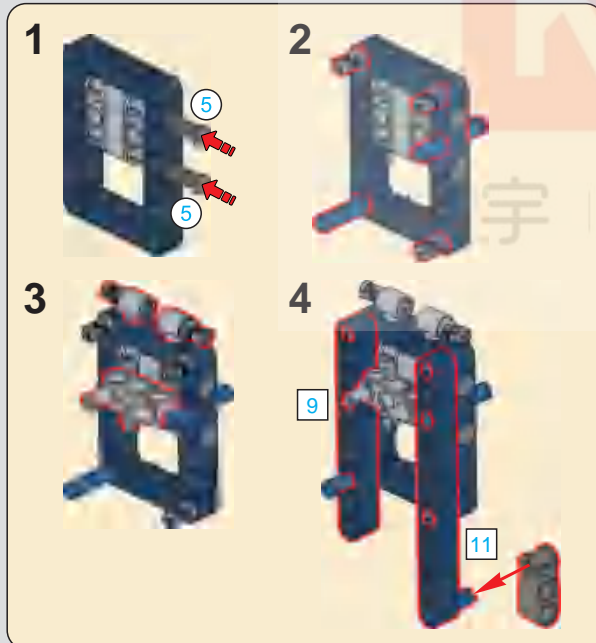

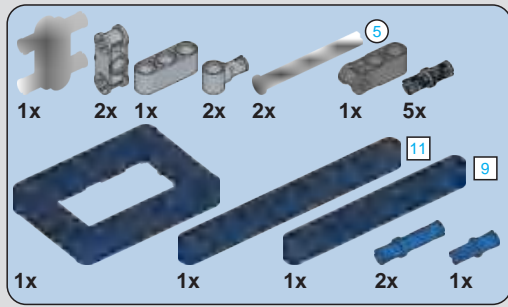

502

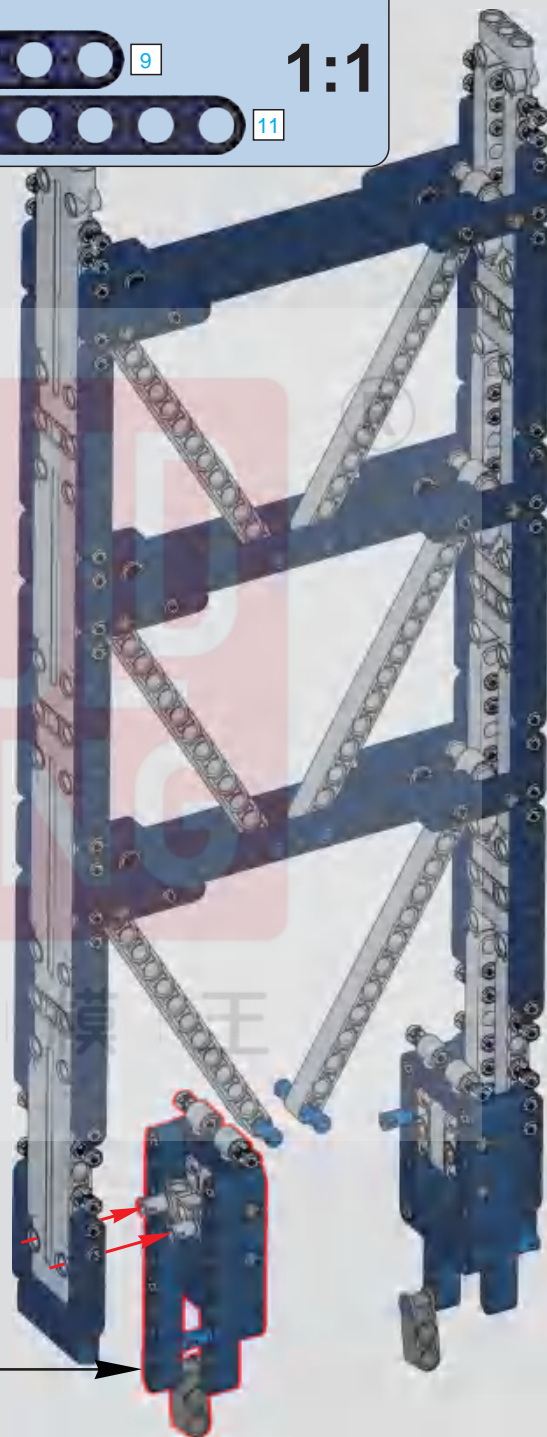
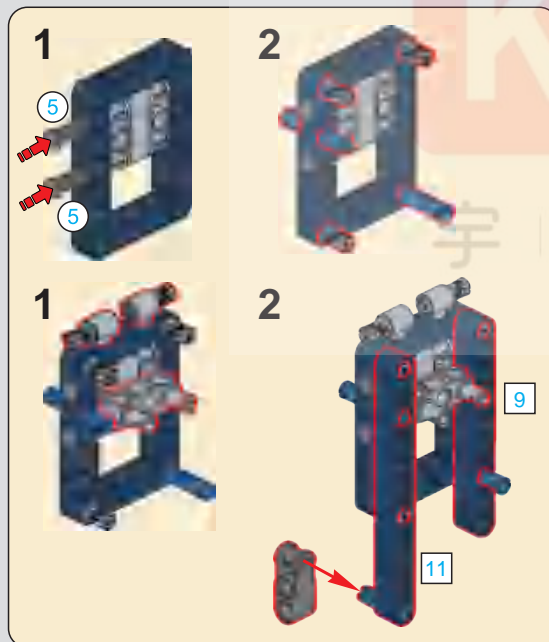
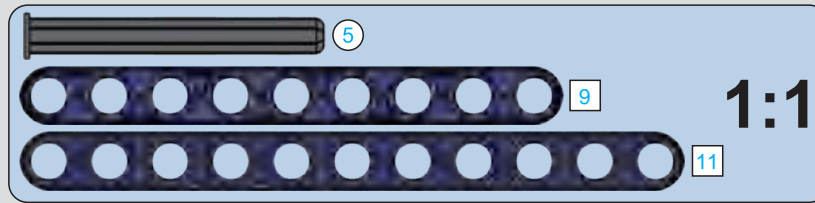



503

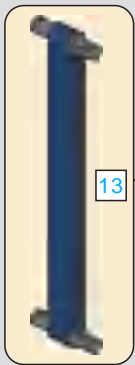
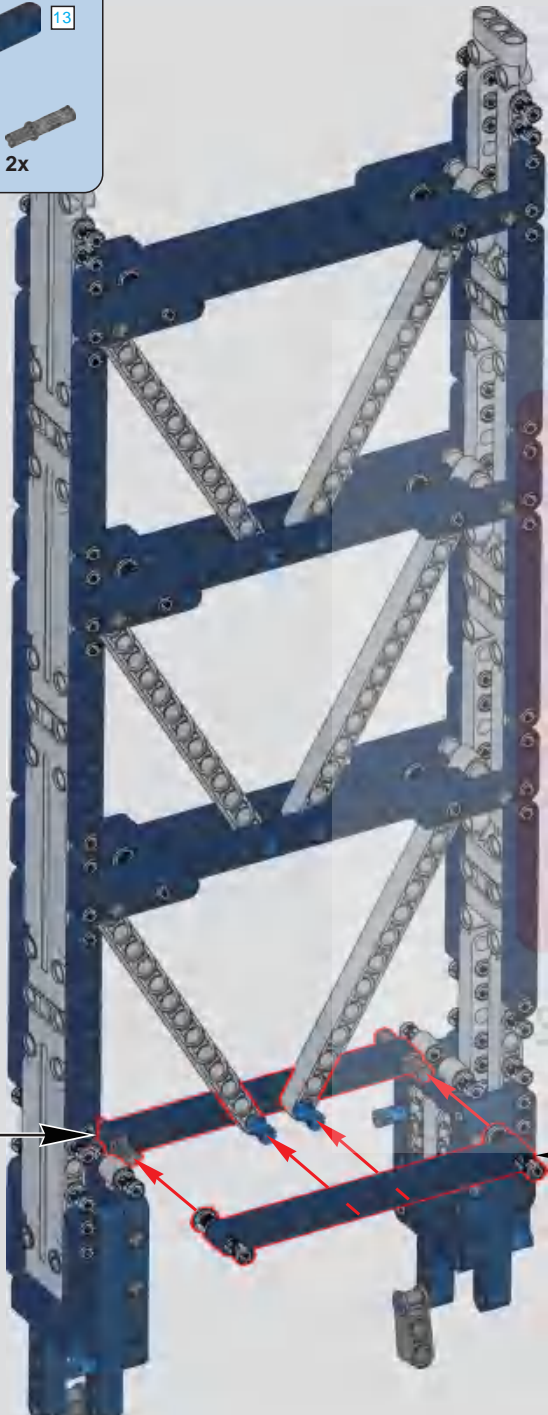

13

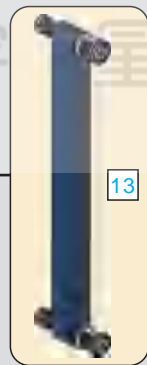

13

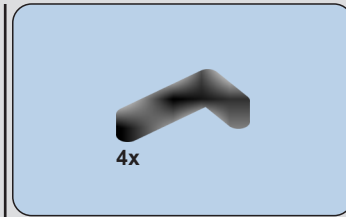

504

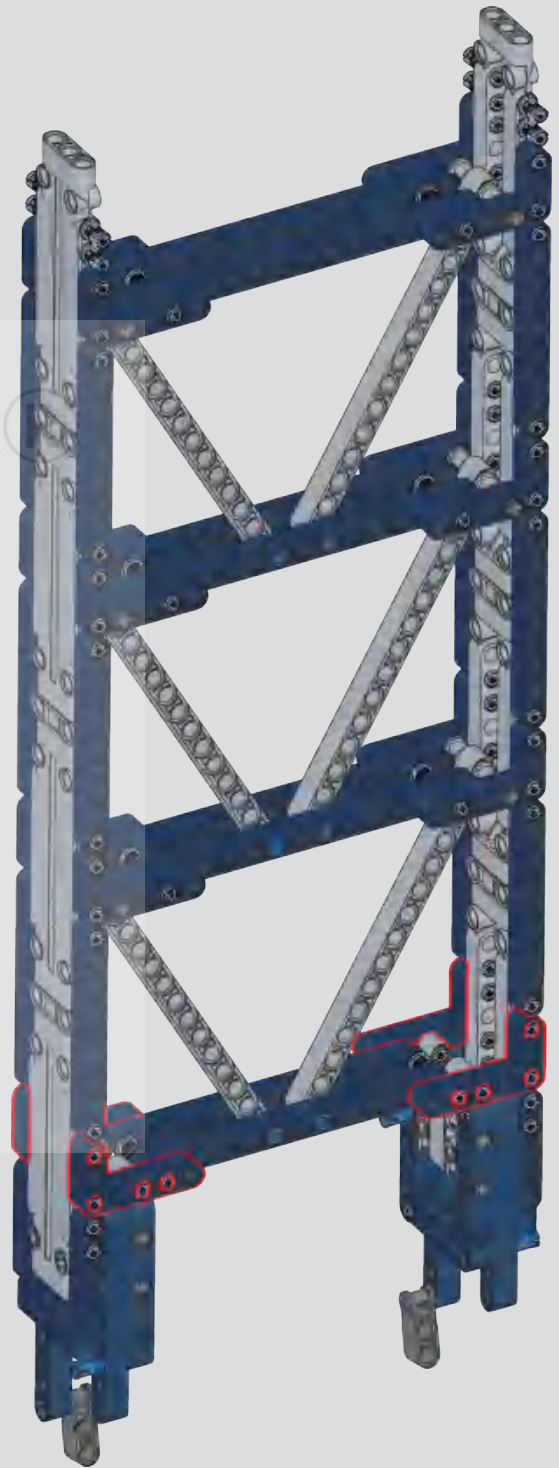

13

1:1

MOULD KING

宇星 | 模 | 王

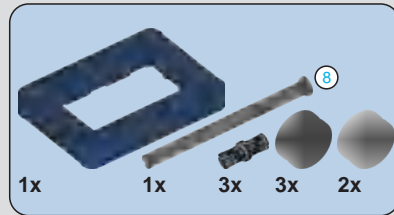
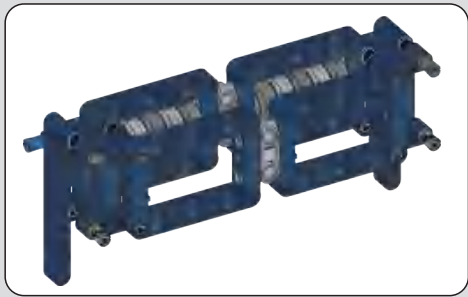

505

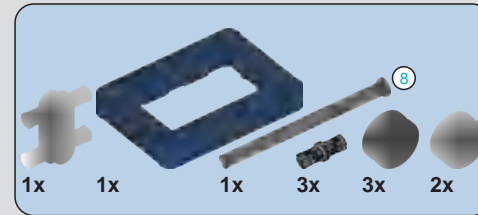

506

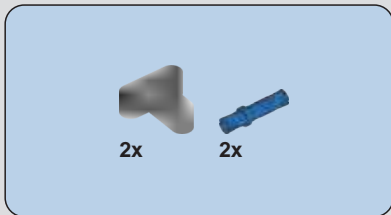
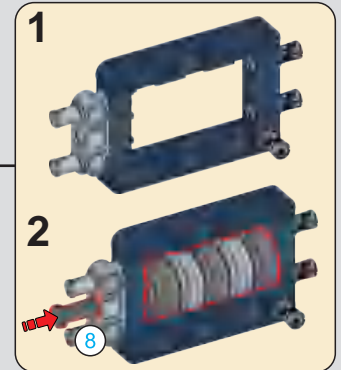

507

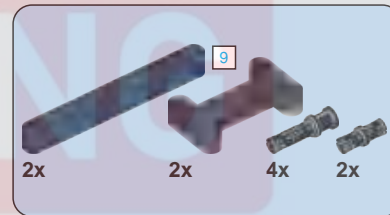

508

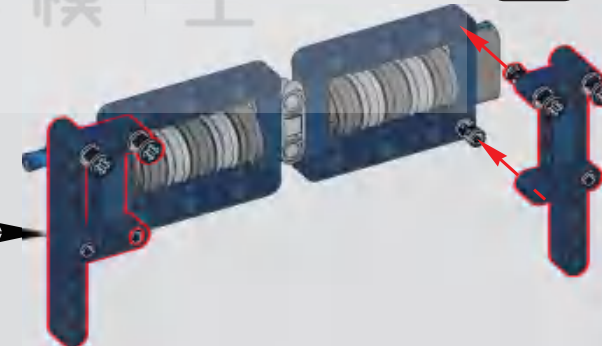

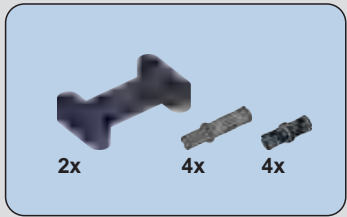

509

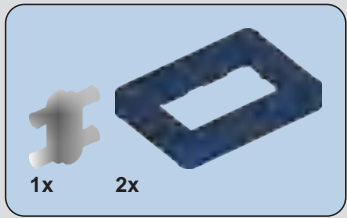
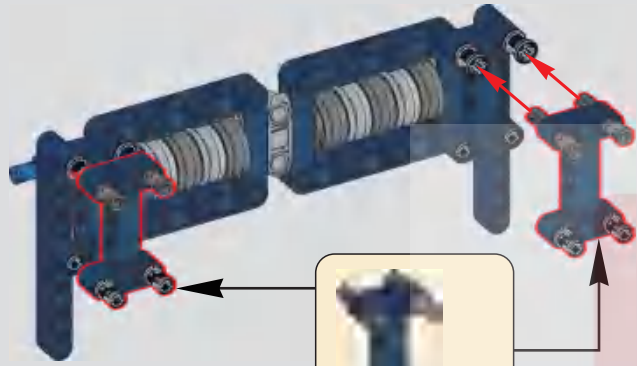

510

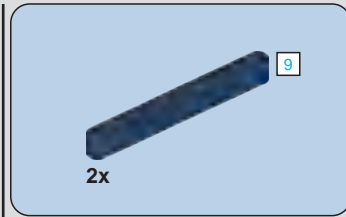
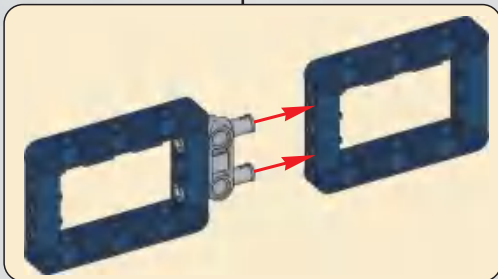
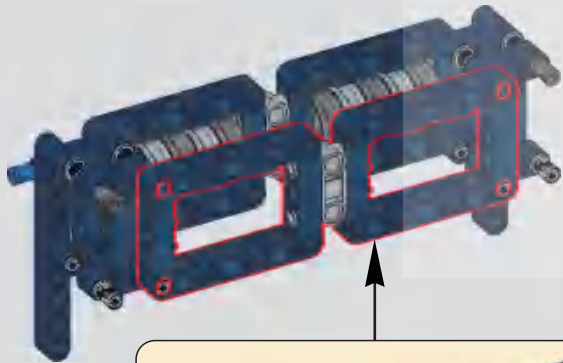

511

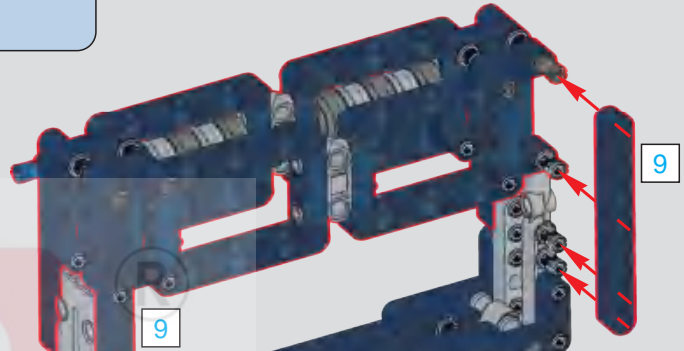

MOULD KING

宇 | 星 | 模 | 王

512



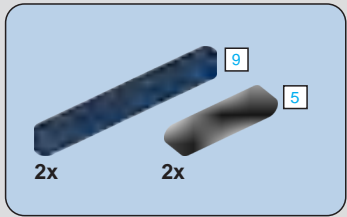

513



514

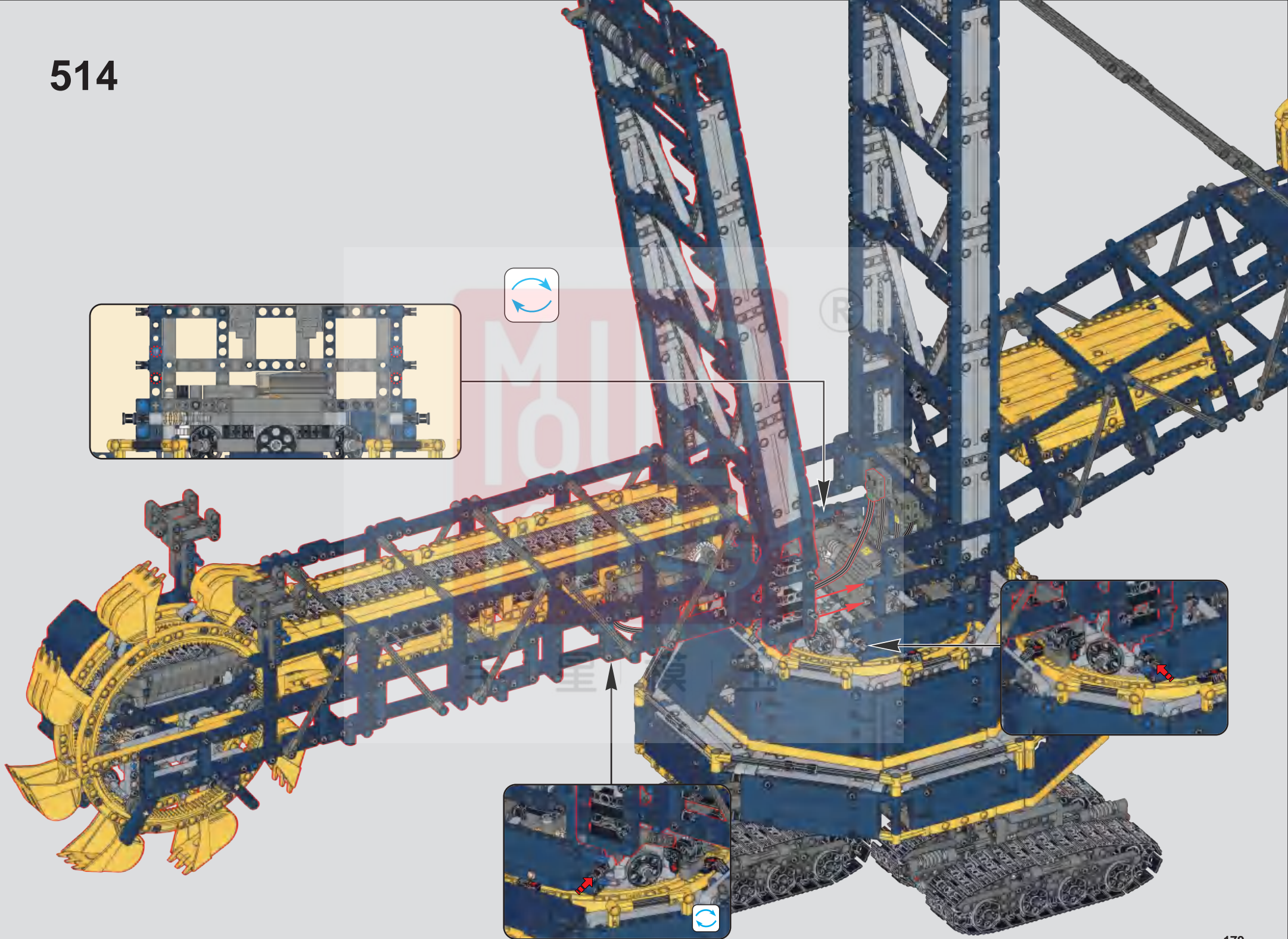

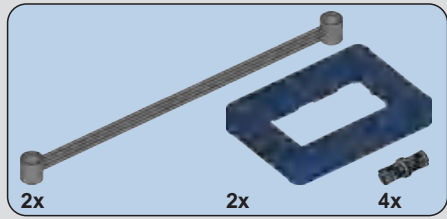

515

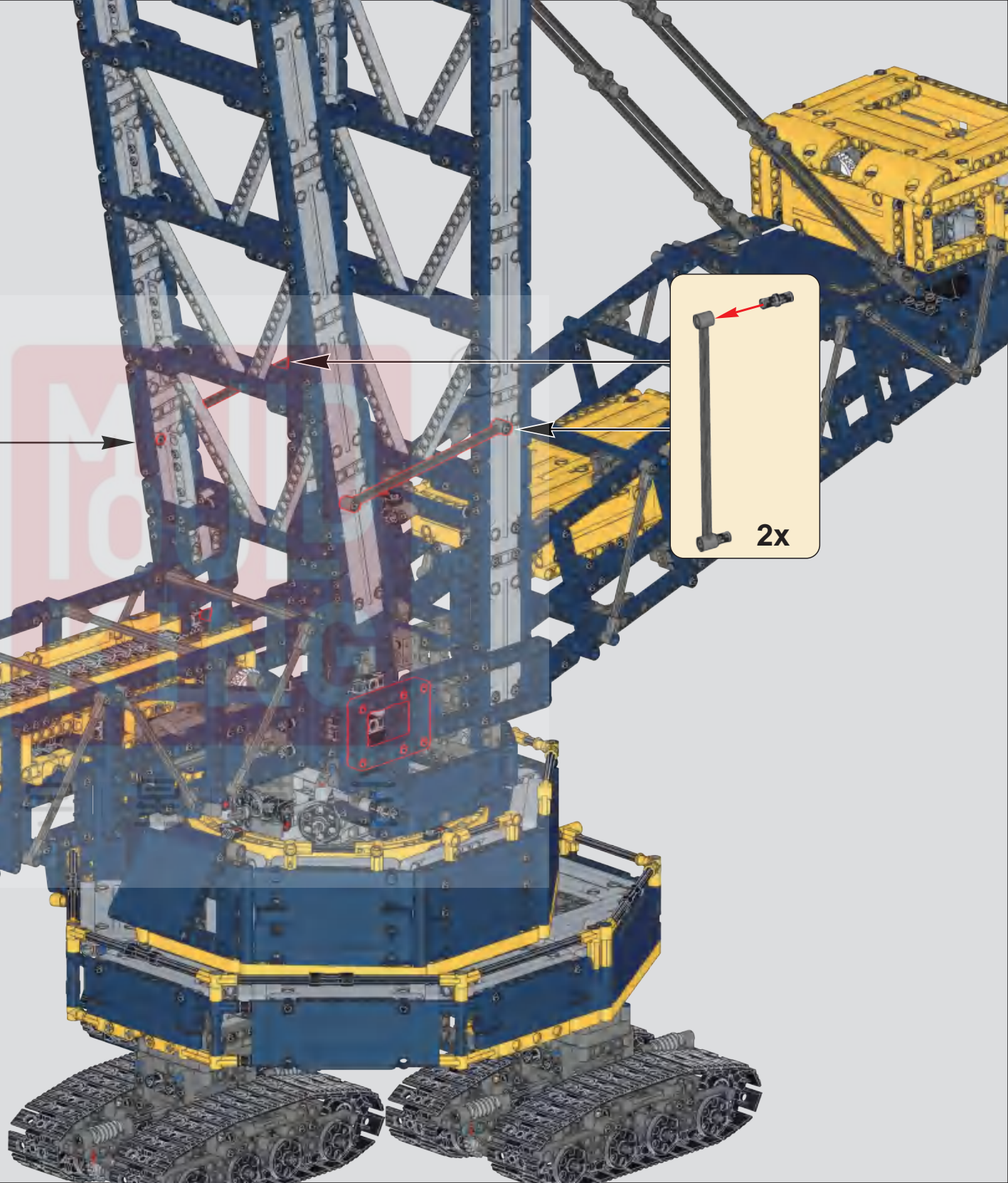
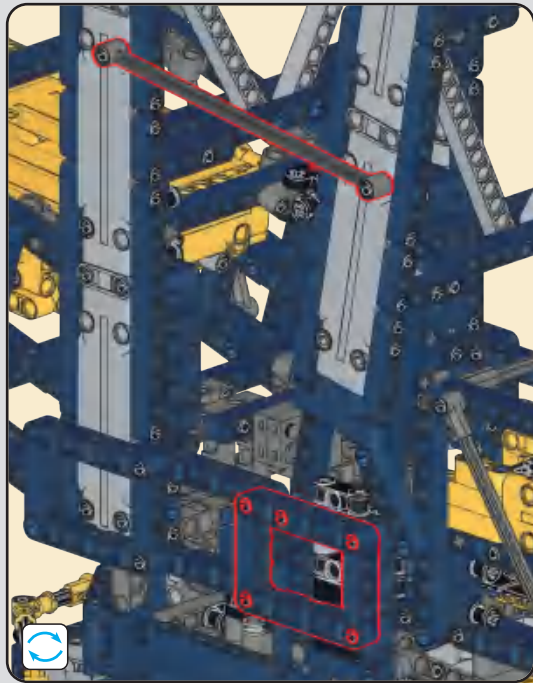

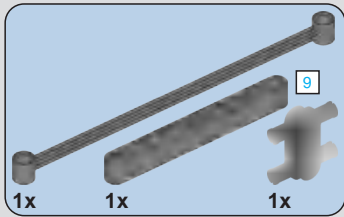

516

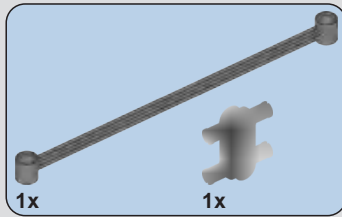
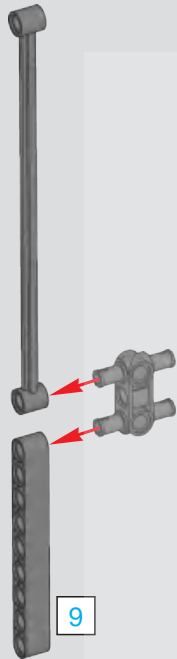

517

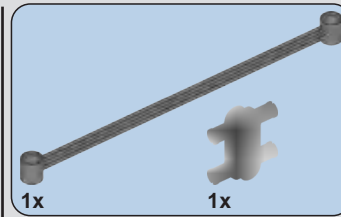

518

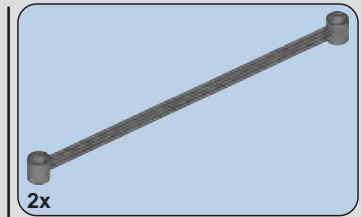

519

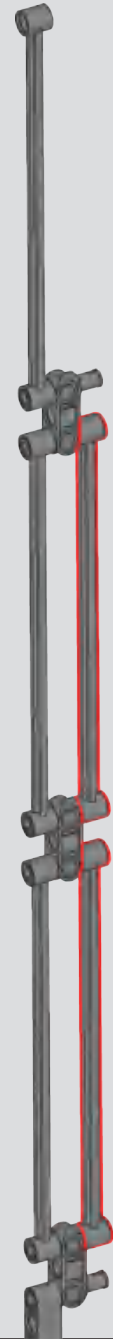

2x

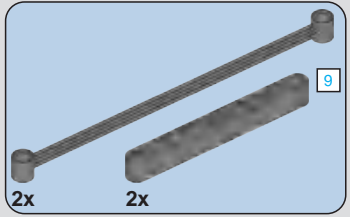

520



9

9

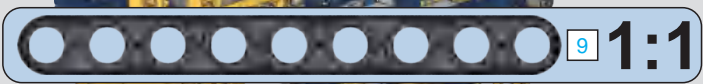
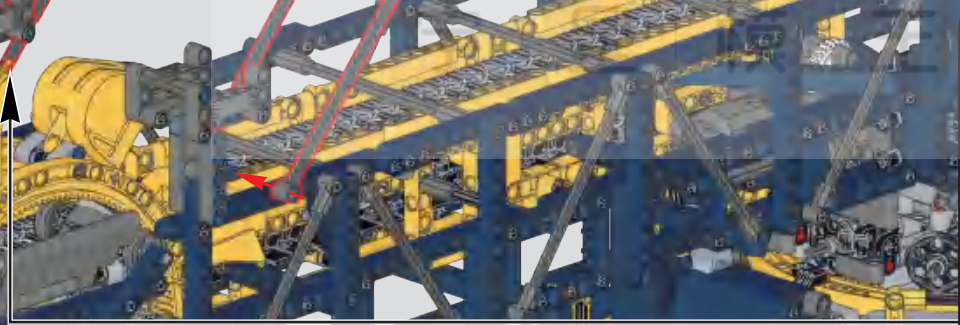



521

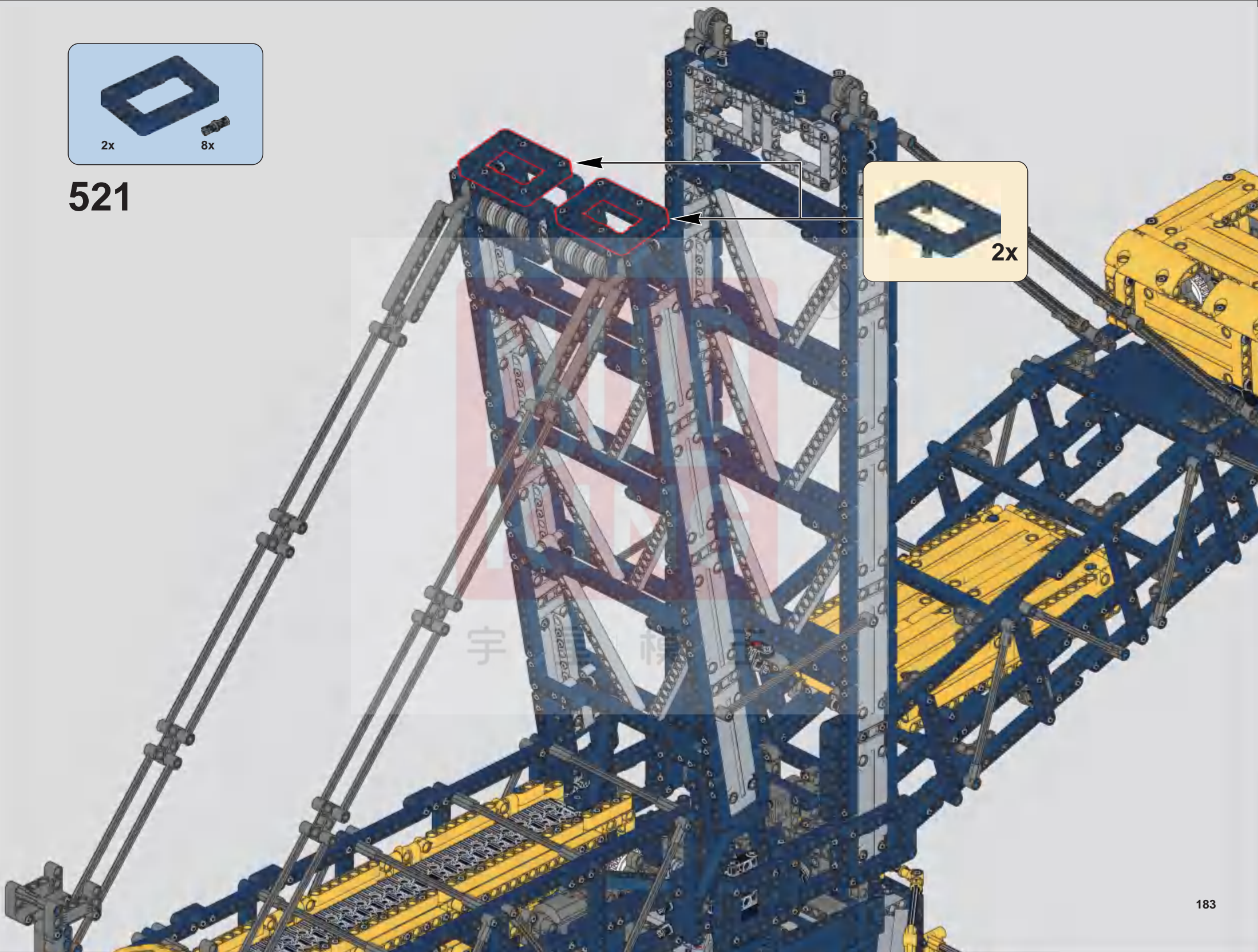

1x  2x 

522

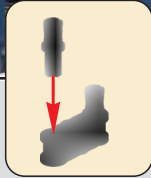

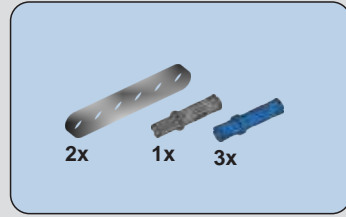

523

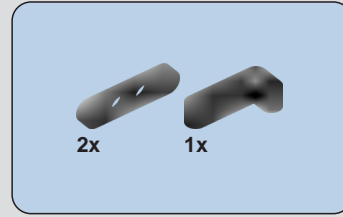

524

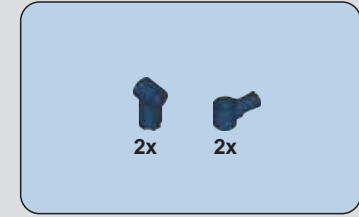

525



526

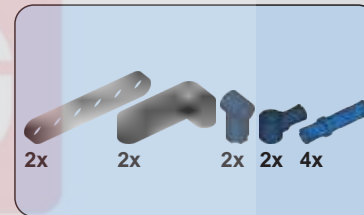

527



528

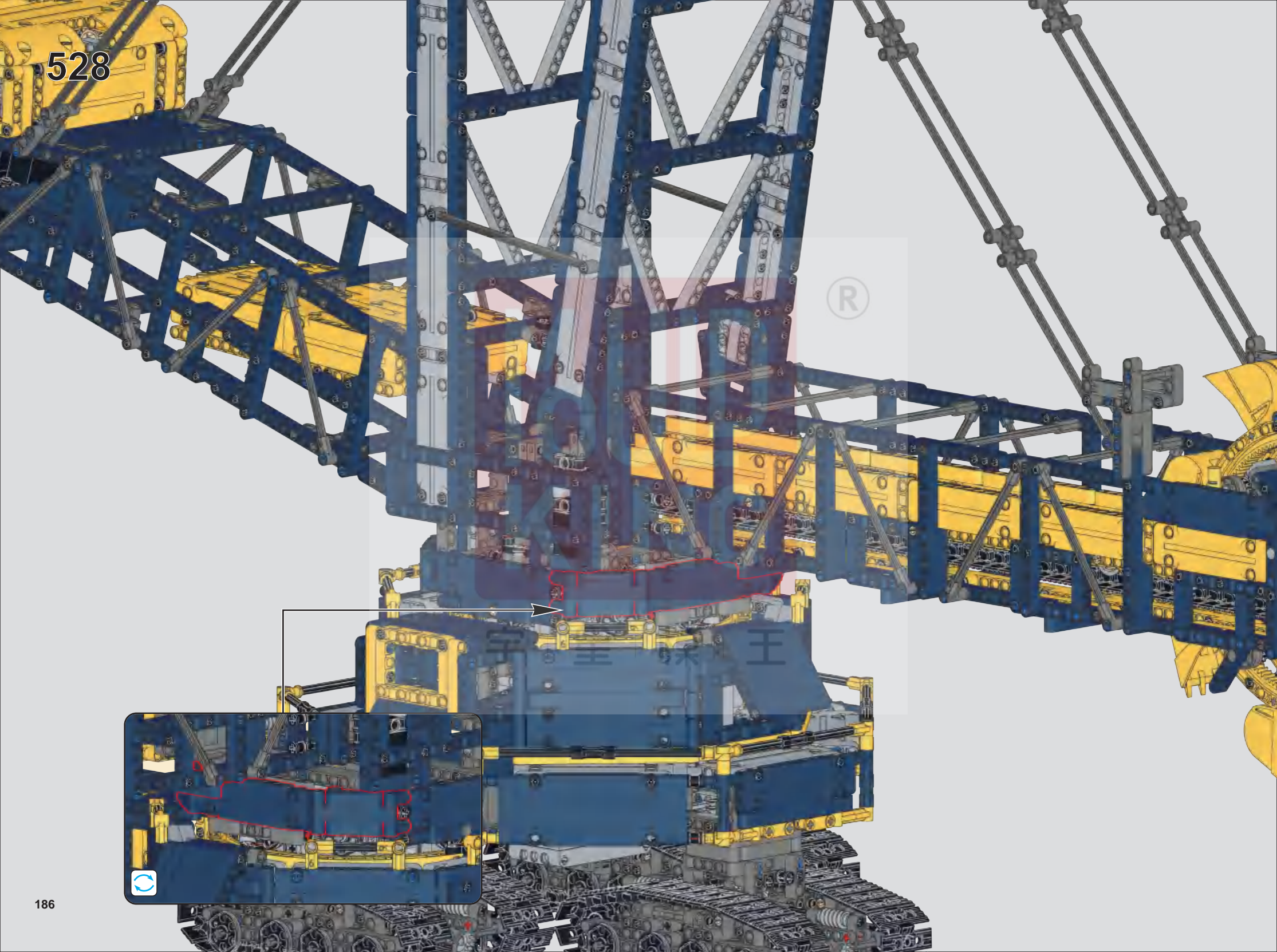

529

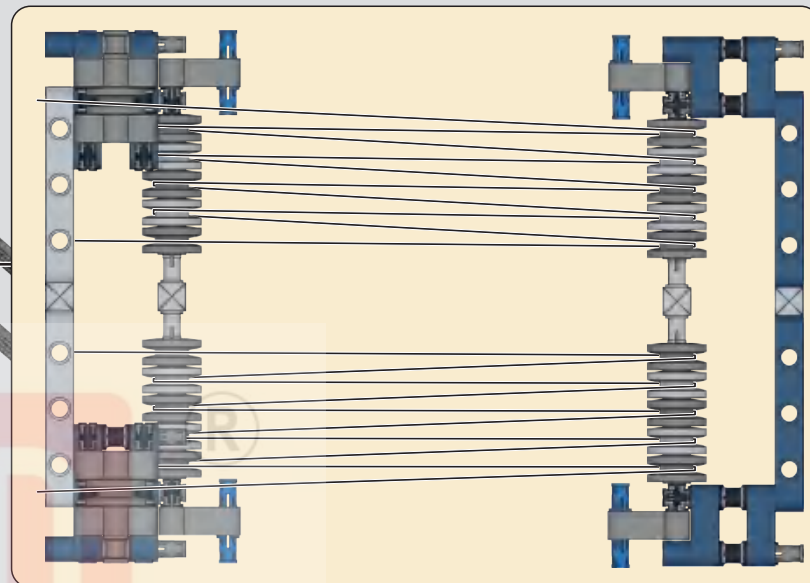
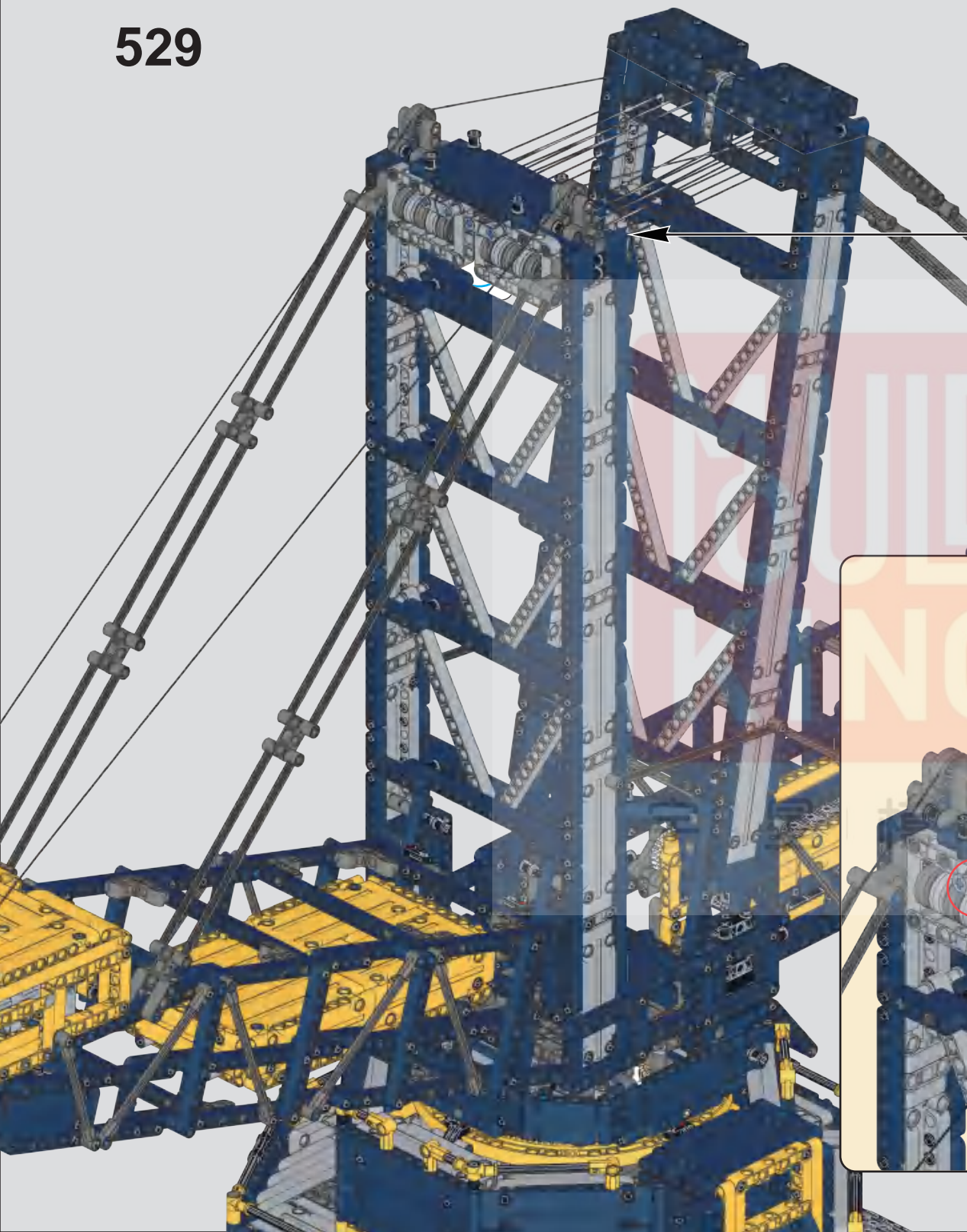

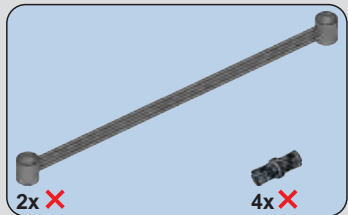

530

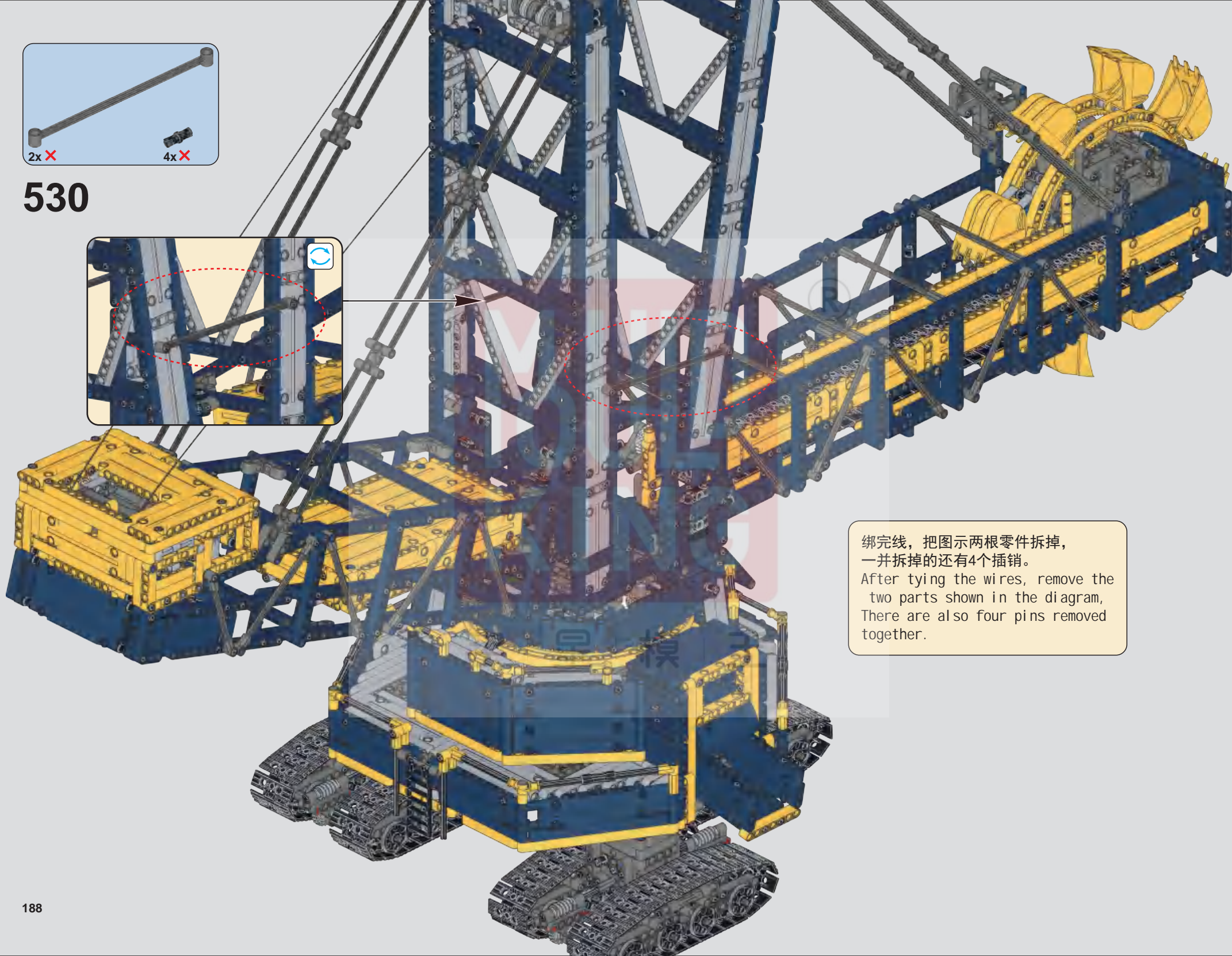
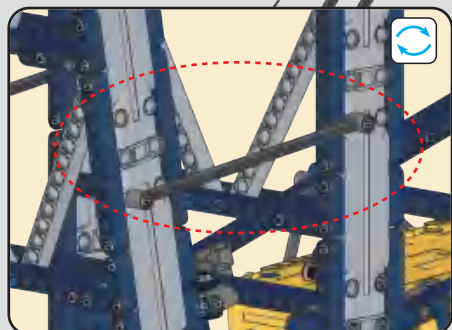

绑完线，把图示两根零件拆掉，
一并拆掉的还有4个插销。
After tying the wires, remove the
two parts shown in the diagram,
There are also four pins removed
together.

531



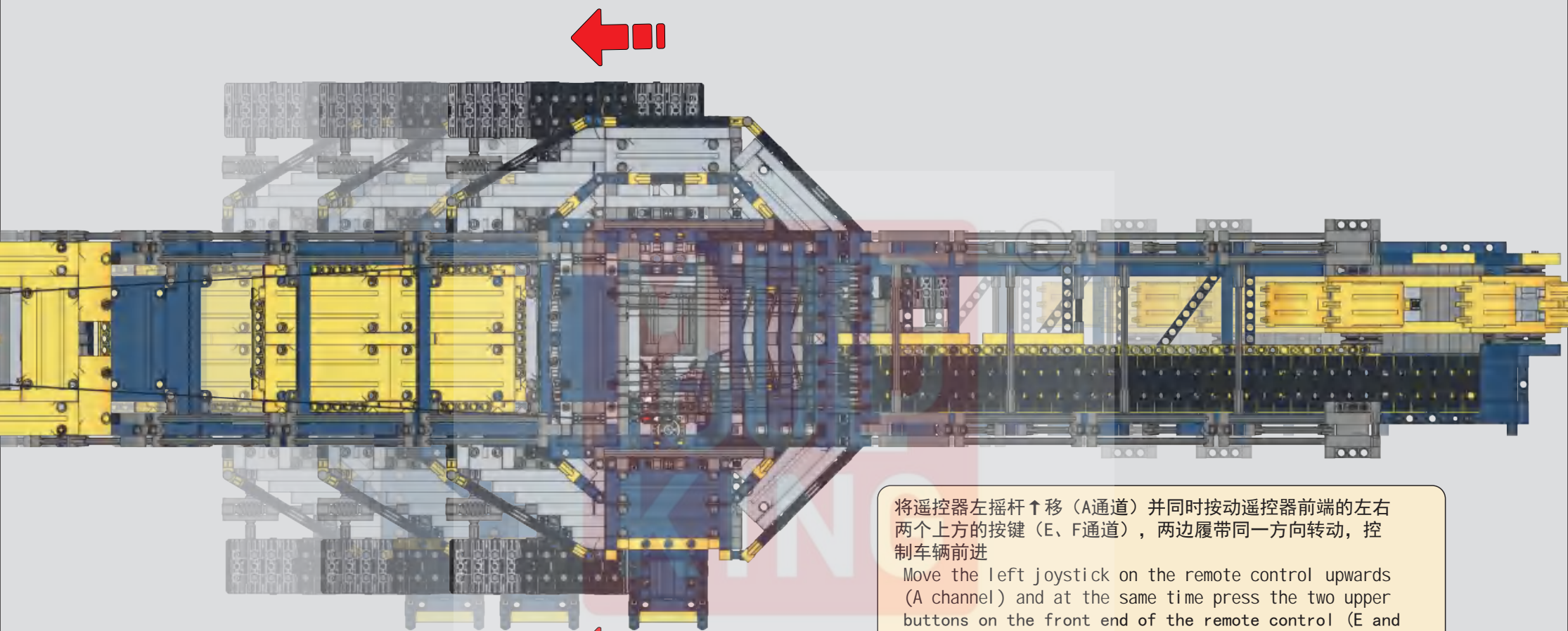

将遥控器左摇杆↑移（A通道）并同时按动遥控器前端的左右两个上方的按键（E、F通道），两边履带同一方向转动，控制车辆前进

Move the left joystick on the remote control upwards (A channel) and at the same time press the two upper buttons on the front end of the remote control (E and F channels). Both tracks will move in the same direction to control the vehicle moving forward.

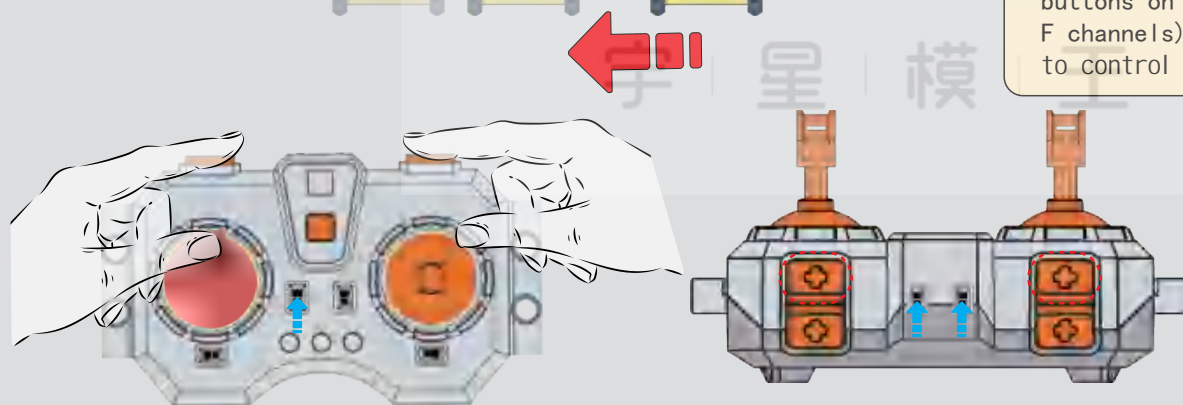

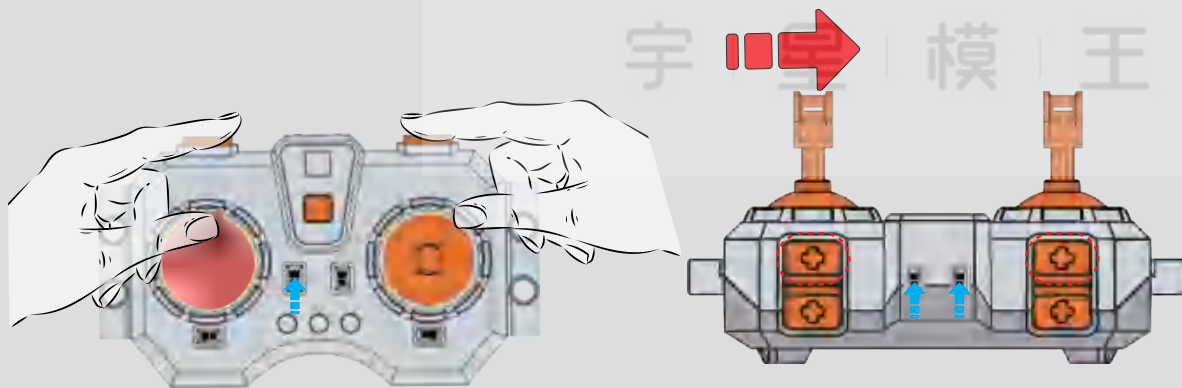
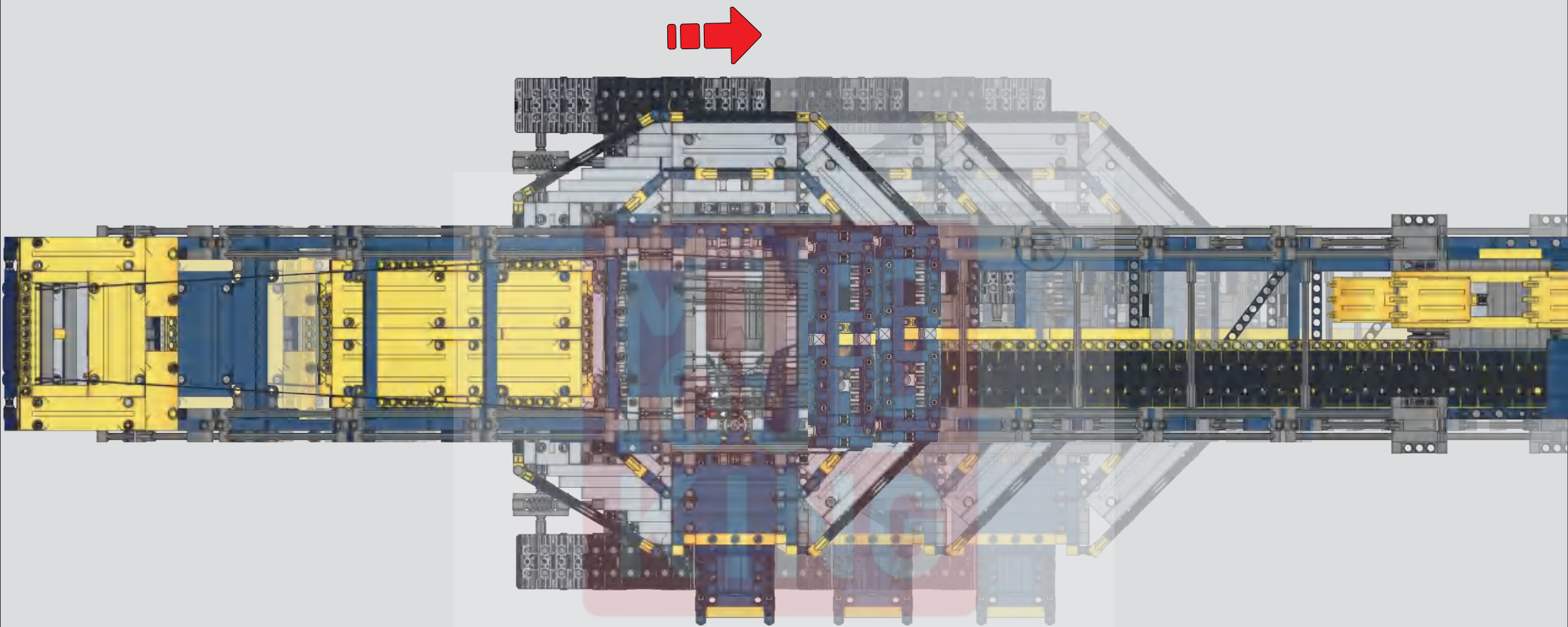

将遥控器左摇杆↓移（A通道）并同时按动遥控器前端的左右两个下方的按键（E、F通道），两边履带同一方向转动，控制车辆后退

Move the left joystick on the remote control downwards (A channel) and at the same time press the two lower buttons on the front end of the remote control (E and F channels). Both tracks will move in the same direction to control the vehicle moving backward.

534

同时按动遥控器前端的右上方键、左上方键（E、F通道），控制车辆左转
Press both the upper right and upper left buttons on the front end of the remote control (E and F channels) simultaneously to control the vehicle turning left.

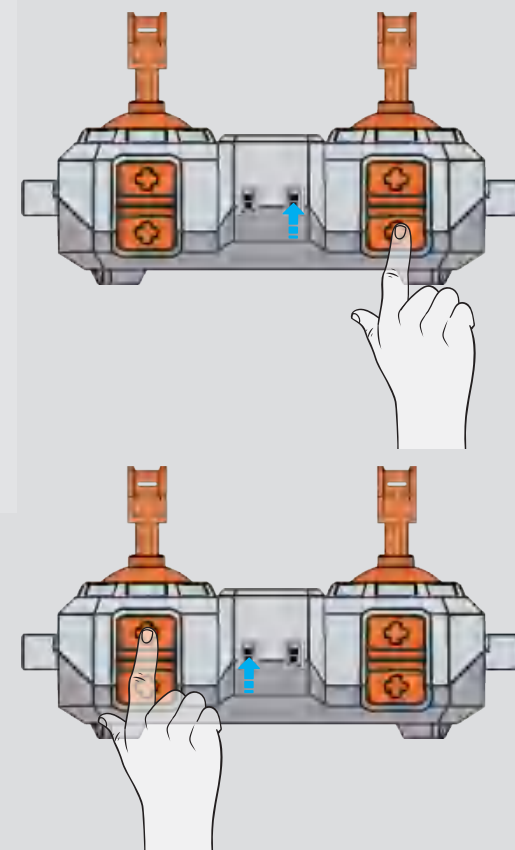

535

同时按动遥控器前端的左上方键、右上方键
(E、F通道)，控制车辆右转
Press both the upper left and upper right
buttons on the front end of the remote
control (E and F channels) simultaneously
to control the vehicle turning right.

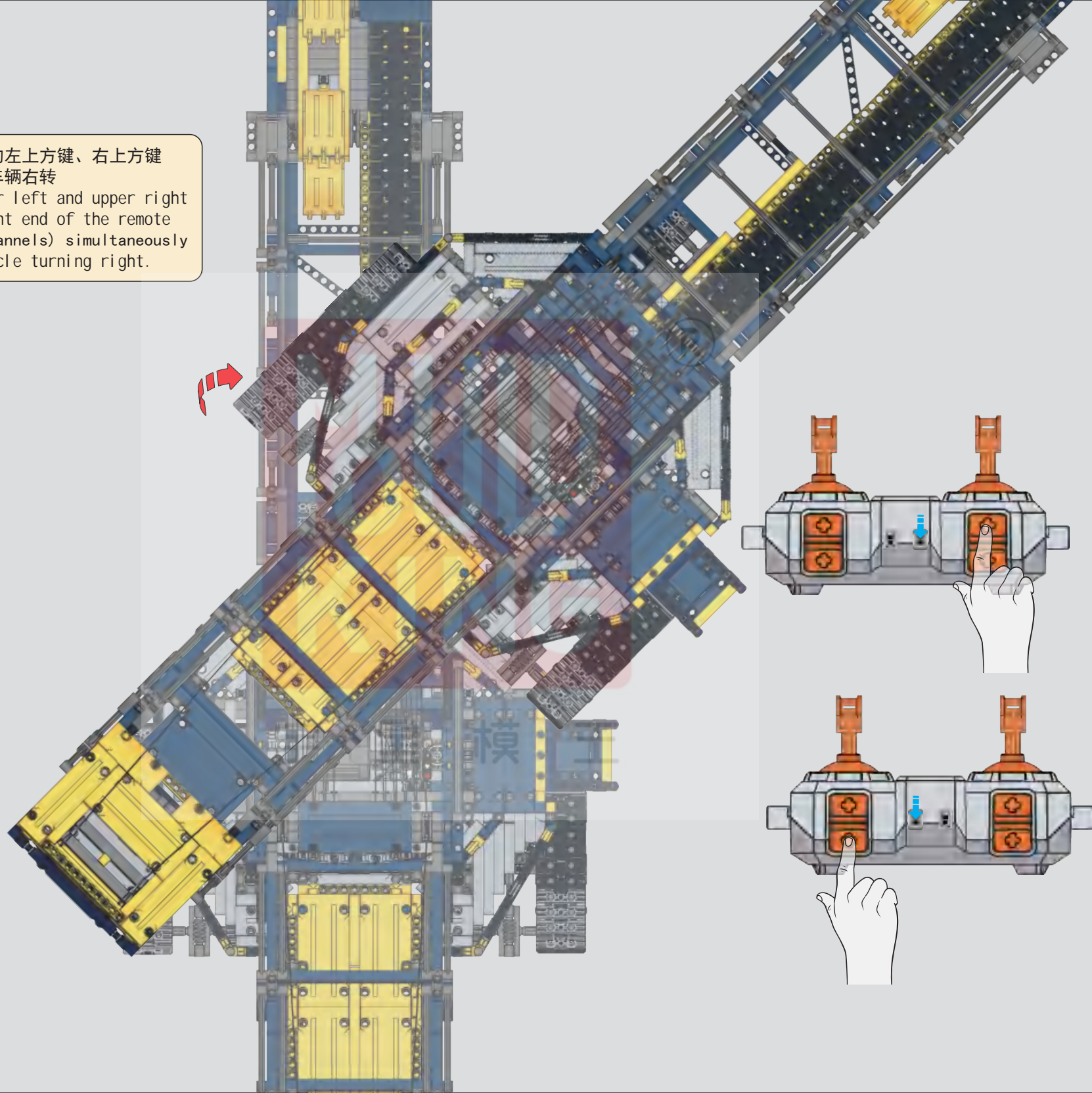



将遥控器右摇杆←→移动 (D通道),
控制上部结构旋转
Move the right joystick on the remote
control to the left or right (D channel)
to control the rotation of the upper
structure.

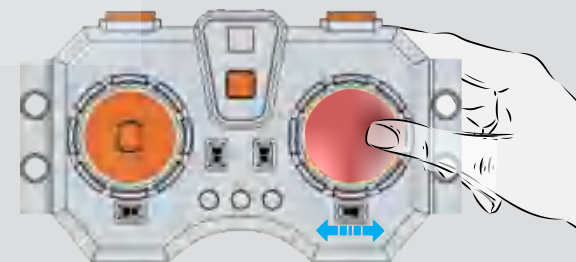



将遥控器左摇杆 \leftrightarrow 移动 (B通道),
控制斗轮旋转
Move the left joystick on the
remote control to the left or
right (B channel) to control the
rotation of the bucket wheel.

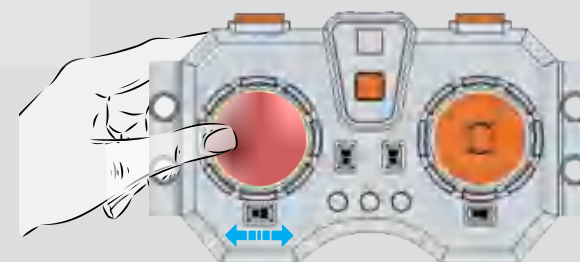



将遥控器右摇杆↑↓移动（C通道），
控制挖臂升降
Move the right joystick on the
remote control up and down (C
channel) to control the lifting
and lowering of the excavator arm.

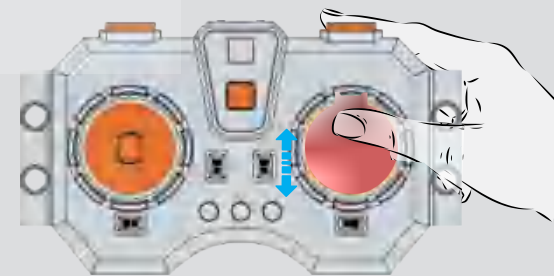

539





宇 | 星 | 模 | 王

