

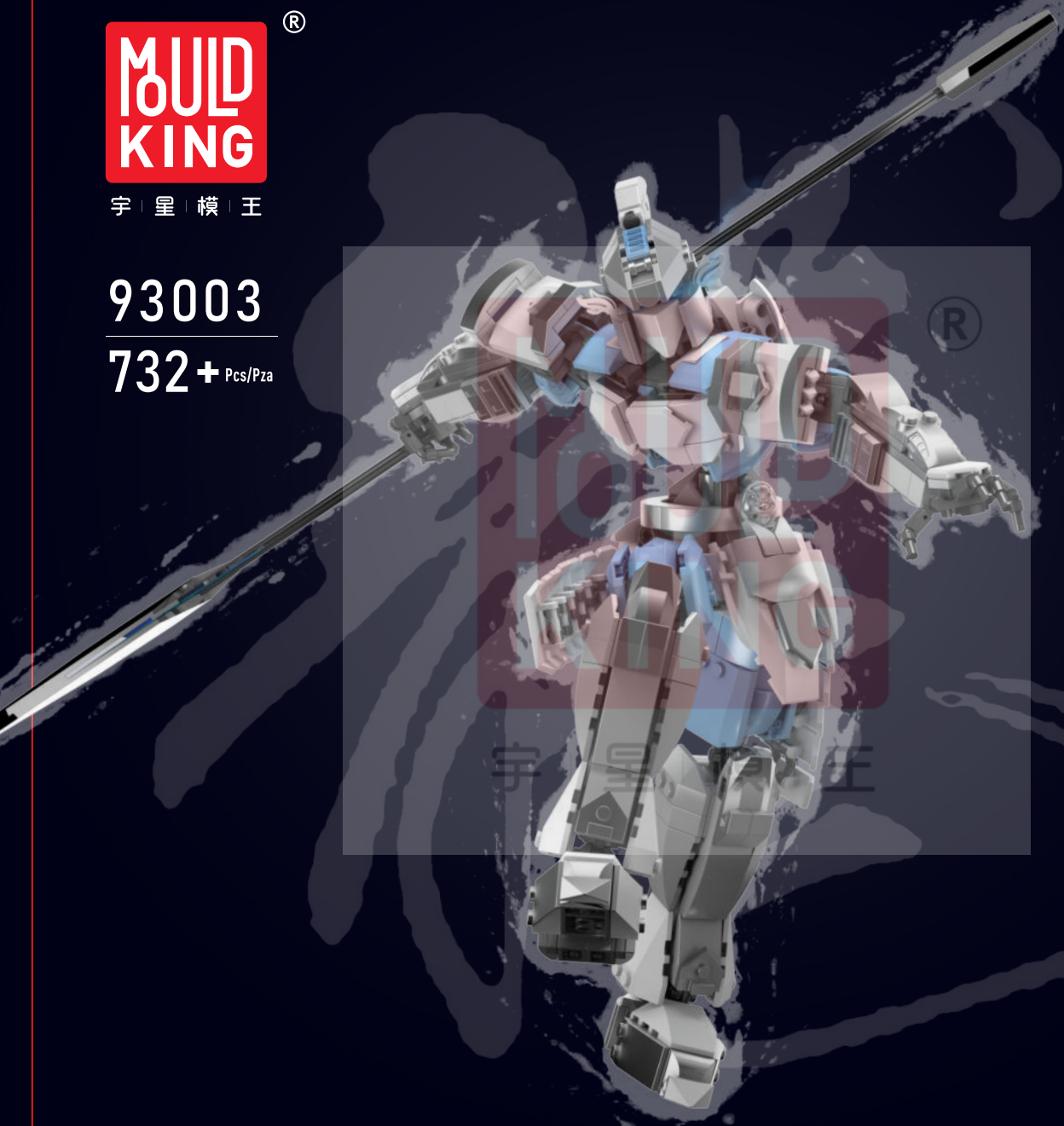

宇 | 星 | 模 | 王

93003

732+ Pcs/Pza



# OPEN

Customer Service  
客户服务  [www.yx-mk.com](http://www.yx-mk.com)



# MOULD KING

广东宇星科技  
微信扫描二维码，关注公众号。  
获取第一手的新品资讯，享受  
便捷的补件服务。

酷砖家  
BriXpert

酷砖家系列是宇星设立的全新子品牌/系列，本系列所有套装均由国内外顶级设计师操刀设计或授权，旨在为消费者带来高水准的积木设计套装和与众不同的拼搭体验。

BriXpert series is a new sub-brand/series set up by Mould King. Models of this series are all designed or authorized by top designers/MOCers around the world, aiming at bringing consumers with high-level brick sets and a unique building experience.

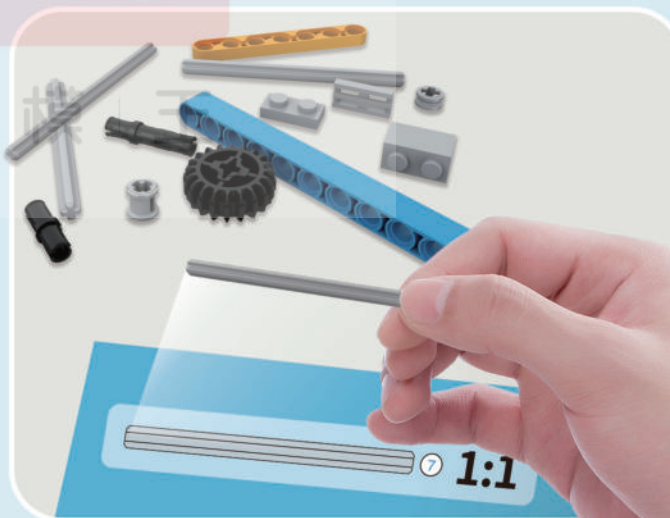



五虎上将, 出自于《三国演义》, 是指汉末三国时期, 跟随刘备建立蜀汉政权的五位将军, 分别为关羽、张飞、赵云、马超、黄忠。陈寿最早作《三国志》时, 将五人并列合为一传, 但还并未提出五虎上将的概念, 而后经过漫长的历史演变, 这五人被塑造成五虎将, 并在文学作品、历史书籍、个人作品集都有不同程度的记录, 在民间更是以艺术的形式被广为流传。随着时代的发展, 五人的顺序也出现各种版本的改变。清乾隆皇帝主持修订的《四库全书》也有将五虎将收录。

Five Tiger Generals, from "The Romance of the Three Kingdoms", refers to the five generals who followed Liu Bei to establish the Shuhan regime during the Three Kingdoms period at the end of Han Dynasty in Chinese history, namely Guan Yu, Zhang Fei, Zhao Yun, Ma Chao, and Huang Zhong. When Chen Shou first wrote "Three Kingdoms", he put five people side by side into one biography, but he didn't put forward the concept of five generals. After a long historical evolution, these five people were shaped into the Five Tigers, and they were recorded to varying degrees in literary works, history books, and personal collections, and they were widely circulated among the people in the form of art. With the development of the times, the order of the characters of the five people has also changed in various versions. The "Siku Quanshu" presided over by Emperor Qianlong of the Qing Dynasty also included the Five Tiger Generals.

赵云，字子龙，常山真定人。身長八尺，姿顏雄偉，漢末三國時期蜀漢名將，與關羽、張飛並稱“燕南三士”。漢末軍閥混戰，趙雲受本郡推舉，率領義勇加入公孫瓚。期間結識了漢室皇親劉備，但不久之後，趙雲因為兄長去世而離開。趙雲離開公孫瓚大約七年後，在邳城與劉備相見，從此追隨劉備。趙雲跟隨劉備將近三十年，先後參加過博望坡之戰、長坂坡之戰、江南平定戰，獨自指揮過入川之戰、漢水之戰、箕谷之戰，都取得了非常好的戰果。除了四處征戰，趙雲還先後以偏將軍任桂陽太守，以留營司馬留守公安，以翊軍將軍督江州。除此之外，趙雲於平定益州時引霍去病故事勸諫劉備將田宅歸還百姓，又於關羽、張飛被害之後勸諫劉備不要伐吳，被後世贊為有大臣局量的儒將，甚至被認為是三國時期的完美人物。趙雲去世後，於蜀漢景耀四年（261年）被追諡為“順平侯”，其“常勝將軍”的形象在後世一直被廣為流傳。



Zhao Yun, courtesy name Zilong, was born in Changshan Zhending. Eight feet long, with a majestic appearance, a famous general of the Shu Han Dynasty in the late Han Dynasty and the Three Kingdoms period in Chinese history, and Guan Yu and Zhang Fei are also known as the "Three Men of Yunnan". Zhao Yun followed Liu Bei for nearly 30 years. He participated in the Battle of Bowangpo, Changbanpo, and Jiangnan Pingding. . In addition to fighting everywhere, Zhao Yun also successively served as the prefect of Guiyang as a general, stayed at the public security as a Sima in the camp, and supervised Jiangzhou as a general of Yijun. In addition, when Zhao Yun pacified Yizhou, he cited the story of Huo Qubing (a famous Chinese general) to persuade Liu Bei to return the fields and houses to the people, and after Guan Yu and Zhang Fei were killed, he advised Liu Bei not to attack Wu, so later generations praised him as a confucian general in the overall situation. He was even considered a perfect character during the Three Kingdoms period. After Zhao Yun's death, he was posthumously named "Shunping Hou" in the fourth year of Jingyao in the Shu Han Dynasty (261), and his image of "Ever-victorious General" has been widely circulated in later generations.



### 心系百姓

建安十七年(212年),刘备与刘璋决裂,从葭萌进攻刘璋势力,并召诸葛亮率军入蜀。

诸葛亮率领赵云与张飞溯江西上,一路平定郡县,直到江州(今重庆),然后兵分两路,诸葛亮、张飞走北路,赵云则另领一军走南路,从外水沿长江而上进至江阳(今四川泸州)、犍为,最后在成都会合。刘备攻下成都之后,任命赵云为翊军将军。

刘备平定益州之后,有议论劝刘备将成都城中房舍及城外园地桑田分赐给诸将。赵云反驳说:“从前霍去病曾说匈奴未灭,无用家为,何况现在国贼不只有像匈奴只有一个,还不到可以安定下来的时候,必须等到天下的乱贼都平定之后,才可让众人返回家乡去种植桑梓,回归故土去耕作田地,这样才是正道。益州的人民是第一次遭遇到战争,应该将田宅房产归还给百姓,先让他们安居乐业,然后才能叫他们服兵役,纳钱粮,也才能得到益州的民心。”刘备便听从赵云的建议。

### Caring for the people

In the seventeenth year of Jian'an (212), Liu Bei broke with Liu Zhang, attacked Liu Zhang's forces from Jiameng, and called Zhuge Liang to lead his army into Shu.

Zhugeliang led Zhao Yun and Zhang Fei back to Jiangxi, all the way to pacify the prefectures and counties, until Jiangzhou (now Chongqing, China), and then divided into two groups, Zhugeliang and Zhang Fei took the north road, and Zhao Yun led another army to go south, from the outer water along the Yangtze River to Jiangyang (now Luzhou, Sichuan, China), Qianwei, and finally meet in Chengdu. After Liu Bei captured Chengdu, he appointed Zhao Yun as the general of Yijun.

After Liu Bei pacified Yizhou, someone persuaded Liu Bei to distribute the houses in Chengdu and the mulberry fields outside the city to the generals. Zhao Yun retorted: "In the past, Huo Qubing (famous general in Chinese history) once said that the enemy is not destroyed, and there is no way to make a home. What's more, there is not only one enemy, and it cannot be settled down. You must wait until the chaos and thieves in the world are calmed down before you can let the soldiers Returning home to cultivate the fields is the right way. The people of Yizhou have encountered war for the first time. We should return the fields, houses and real estate to them, let them live and work in peace and contentment first, and then call them into military service and let them pay money and food. Only in this way can we win the hearts of the people in Yizhou." Liu Bei followed Zhao Yun's suggestion.



## 宇 | 星 | 模 | 王

亮银枪又名涯角枪、龙胆亮银枪。古代十大名枪之一，为三国中赵云所使用的武器。赵子龙，左手青虹剑，右手亮银枪，跨下白龙马，一身白盔白甲，长坂坡单骑救主，于百万曹军中往返折杀，所向披靡，如此猛将乃常山赵云赵子龙是也。

The bright silver gun is also known as the corner gun and the gentian bright silver gun. One of the top ten famous guns in ancient times, it is the weapon used by Zhao Yun in the Three Kingdoms in Chinese history. Zhao Zilong, with a blue rainbow sword in his left hand and a silver spear in his right hand, stepped off a white dragon horse, wearing a white helmet and white armor. Chang Banpo rode alone to save his master, and fought back and forth among millions of Cao troops. He is very invincible. Such a fierce general is Chang Shan Zhao Zilong.

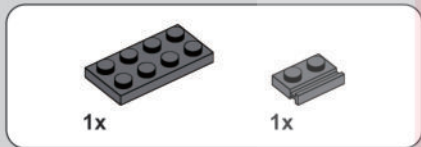
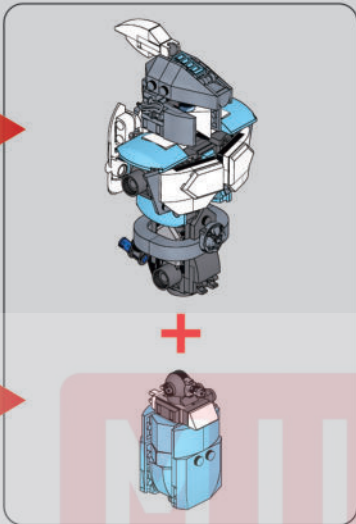

1

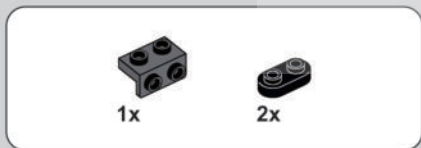
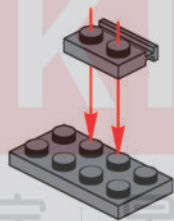

2

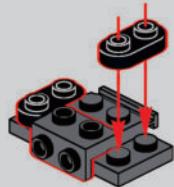

3

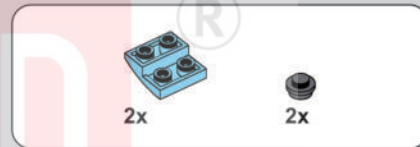
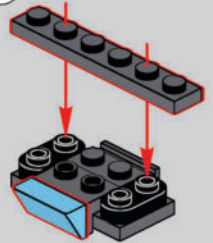

4

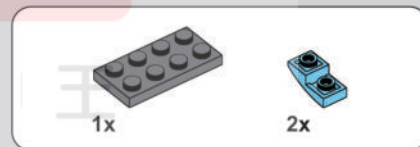
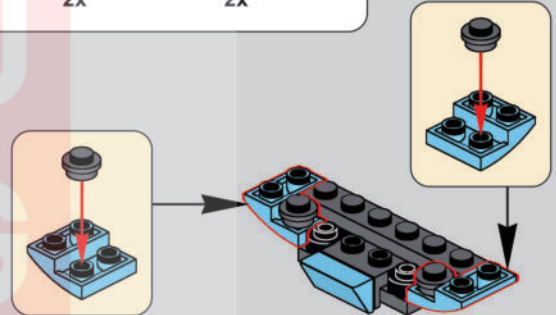

5

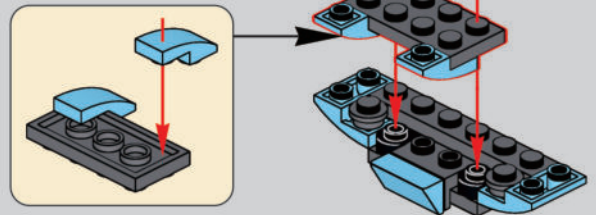



3x

6

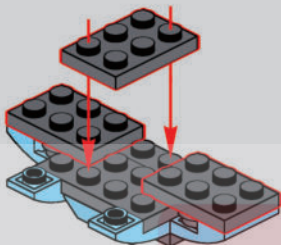

1x



2x

7

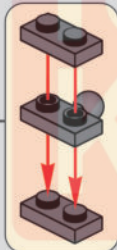
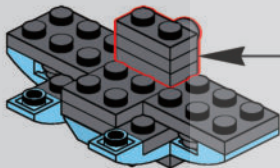

1x



1x

8

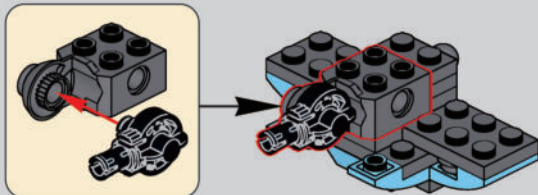

2



2x



1x



1x



1x

9

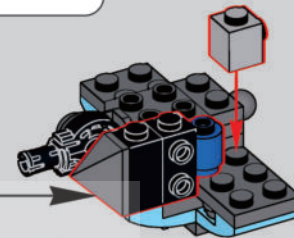
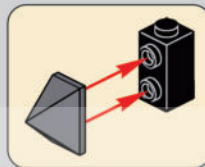

2x



1x



1x



1x

10

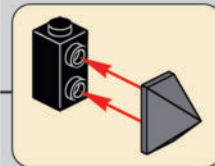
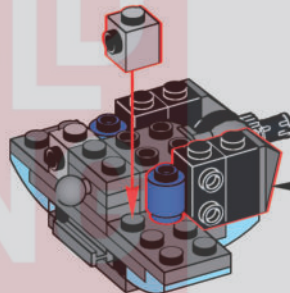

2x



2x

11

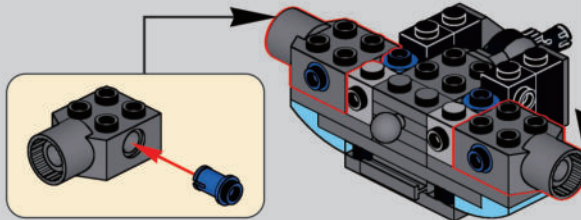
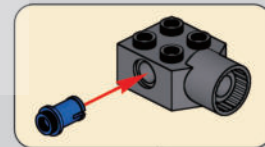



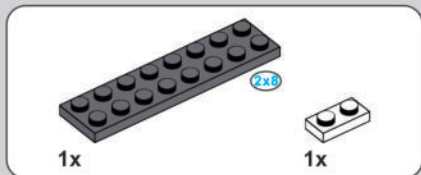

12

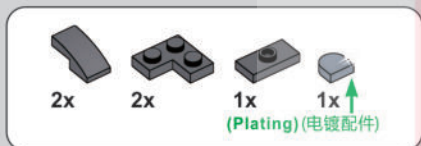
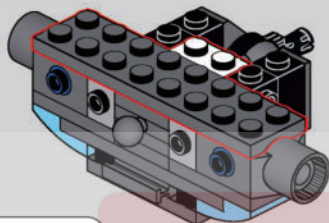

13

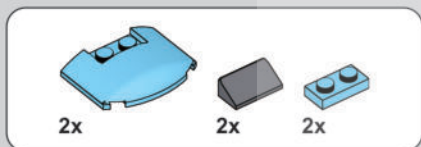
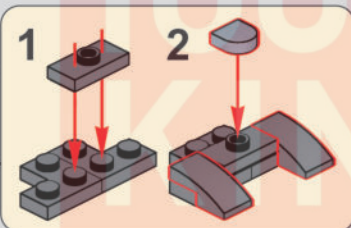
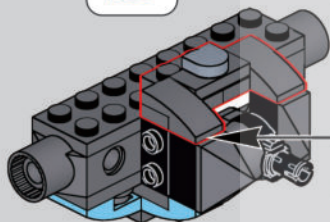

14

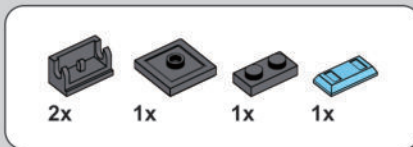
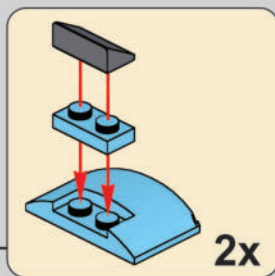
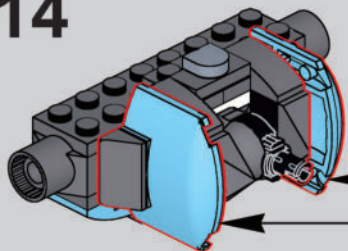

15

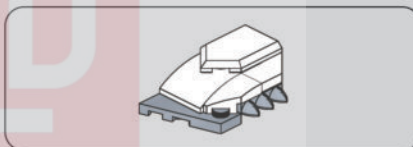
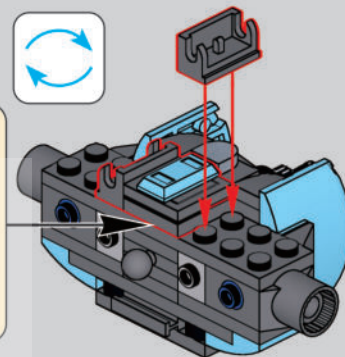
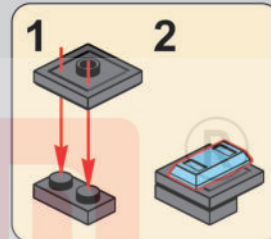

16

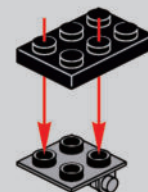

17

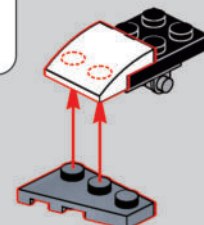



18

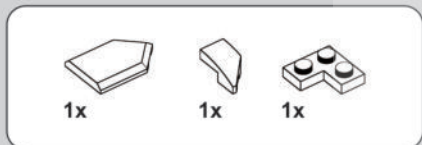
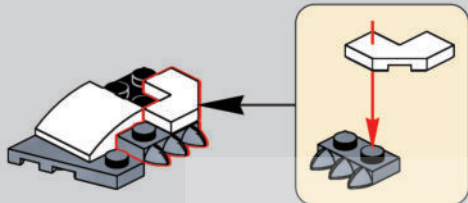

19

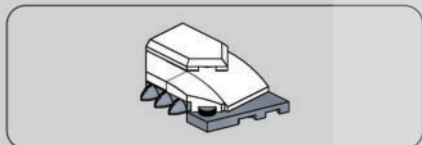
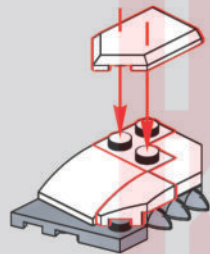

20

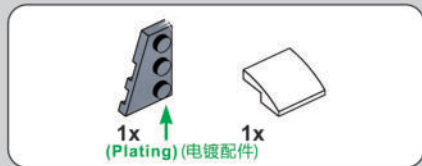
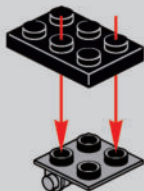

21

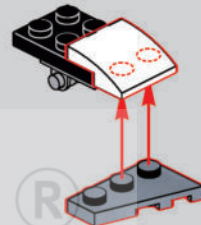

22

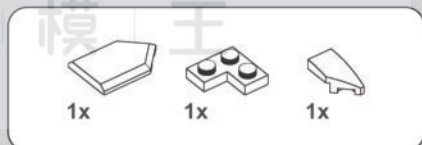
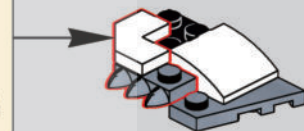
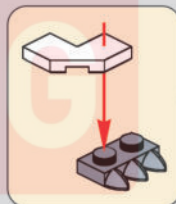

23

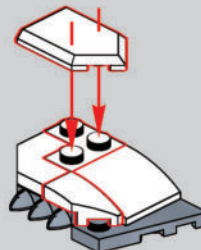

24

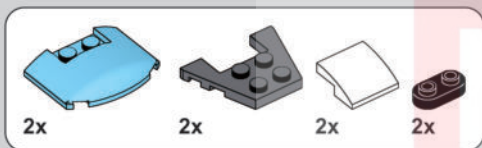
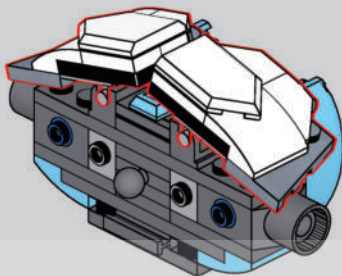

25

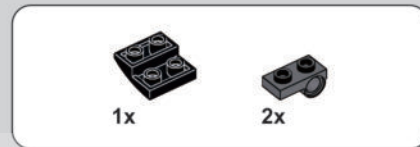
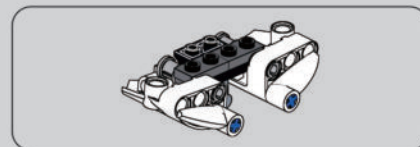
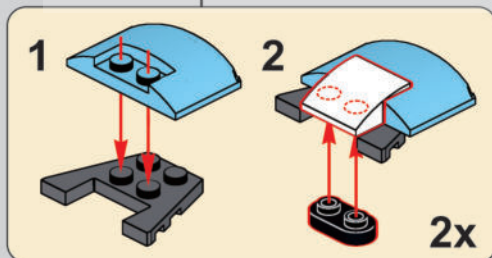
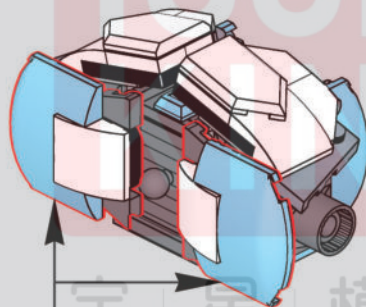
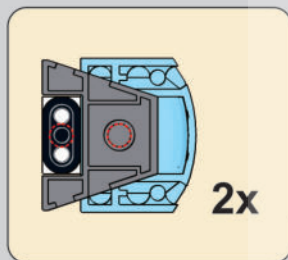

26<sup>®</sup>

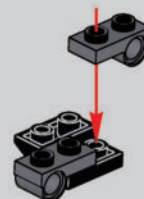

27

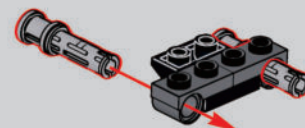

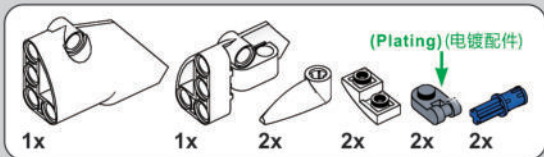

28

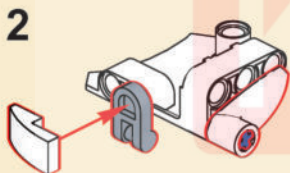
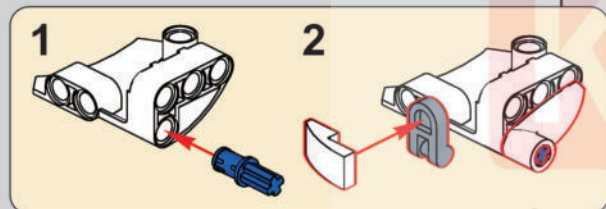
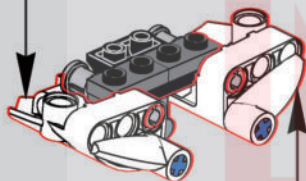
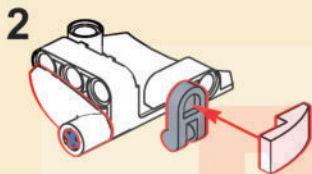
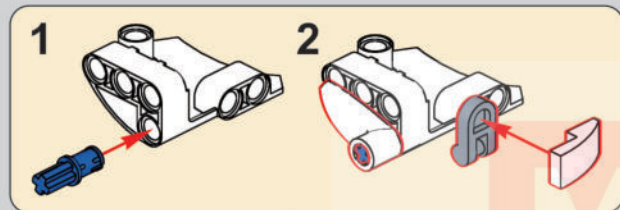

29

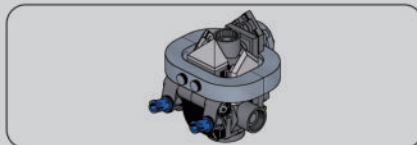
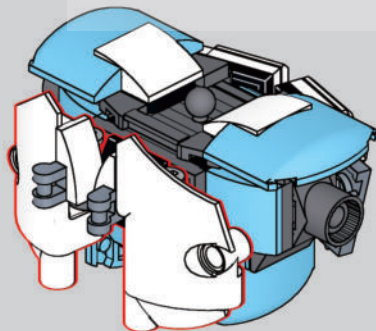

30

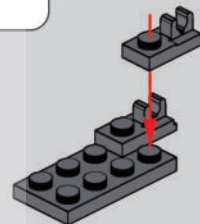

31

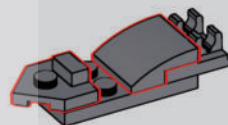

32

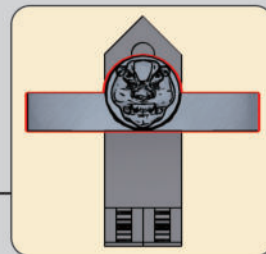
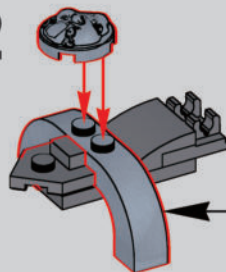

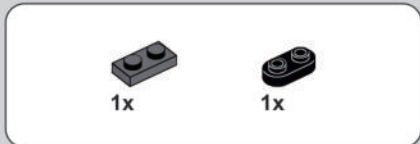

33

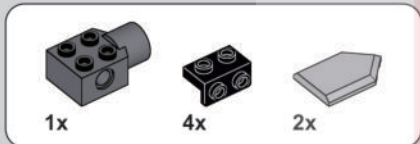
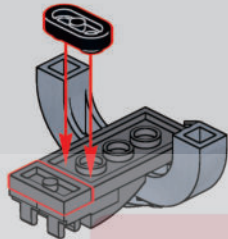

34

1

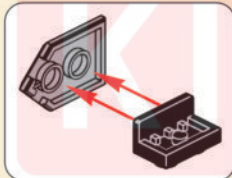
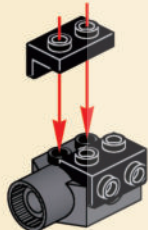

2

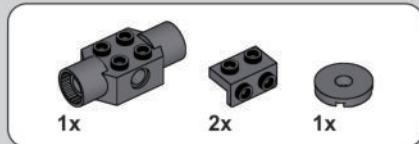
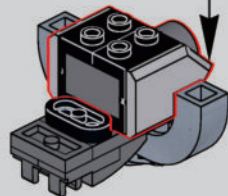
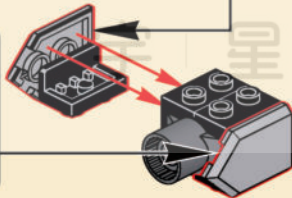
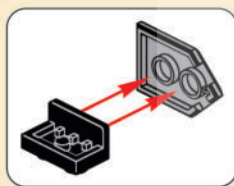

35

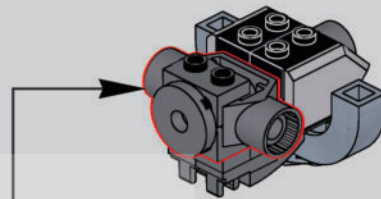

1

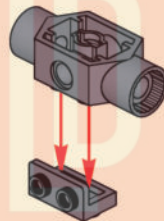

2

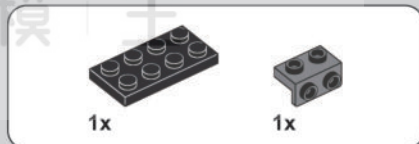
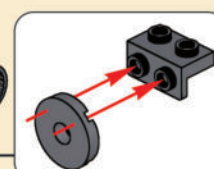
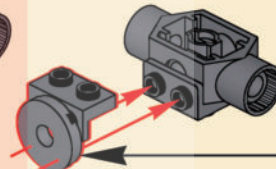

36

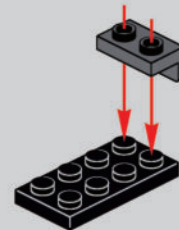



2x

37



1x  
(Plating) (电镀配件)



1x



2x

38

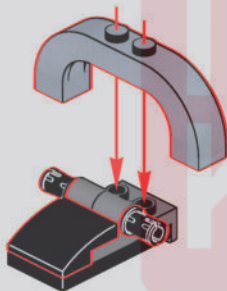

2x



2x

39

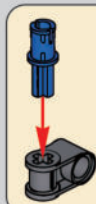

2x

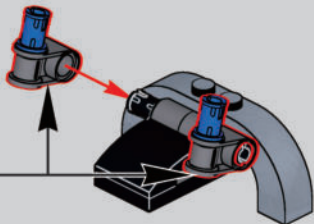

1x



1x

40

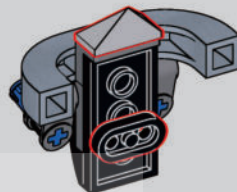

41

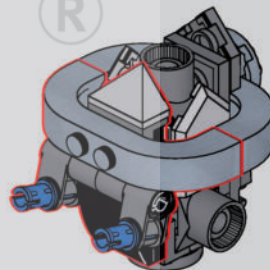

42

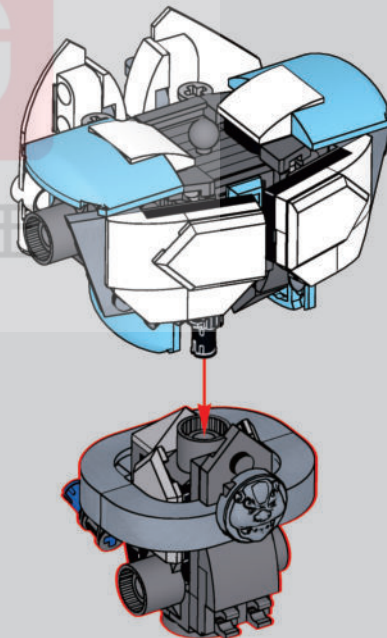

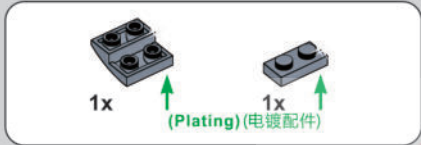
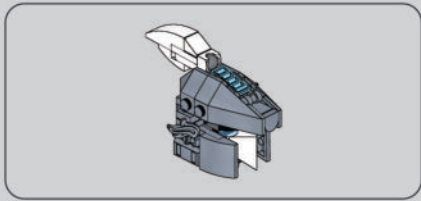

43

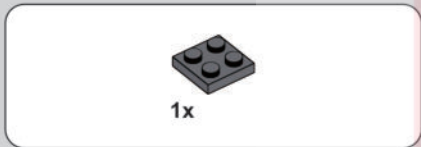
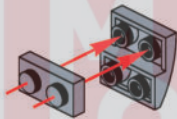

44

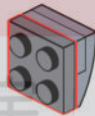

45

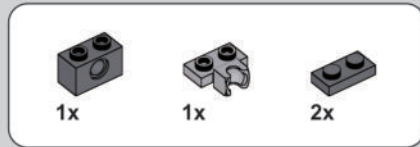
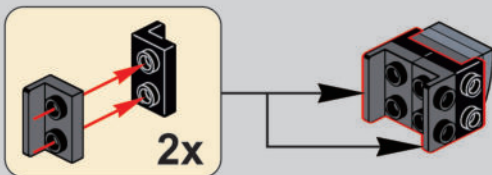

46

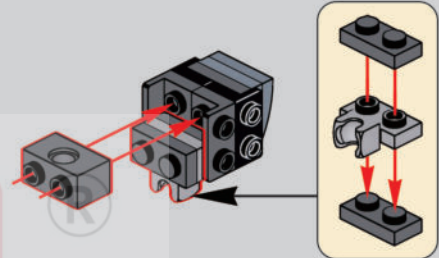

47

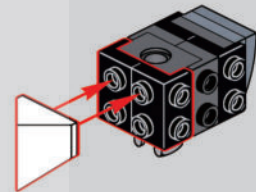

48

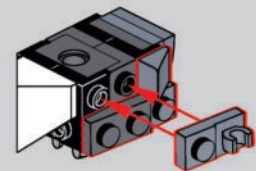



49

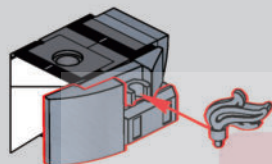

50

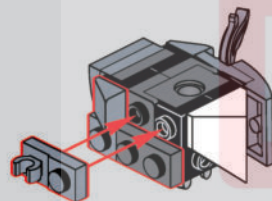

51

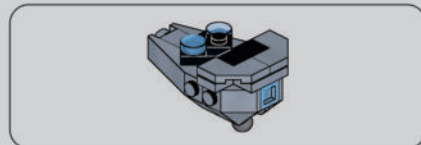
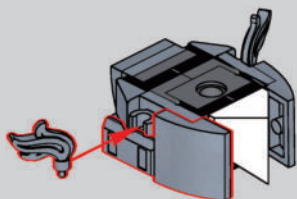

52

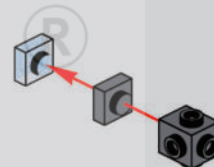

53

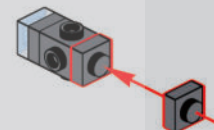

54

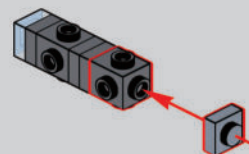





55

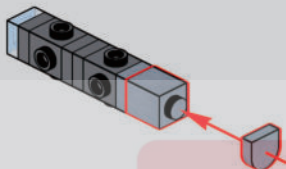

56

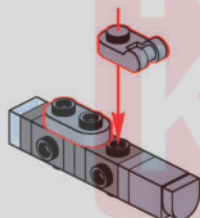

57

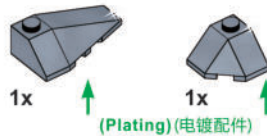
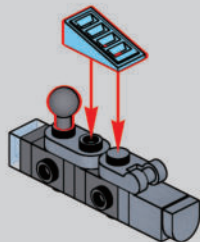

58

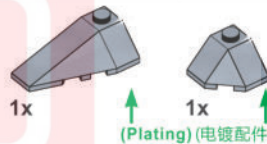
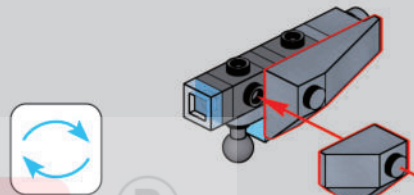

59

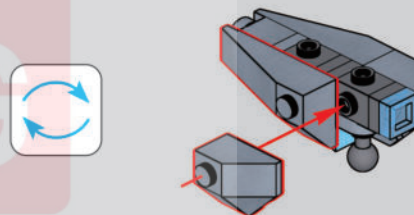

60

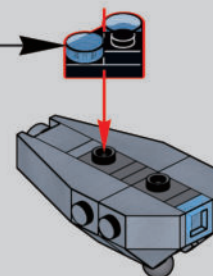
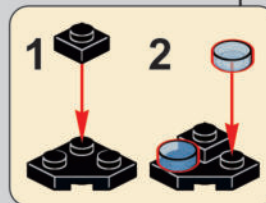

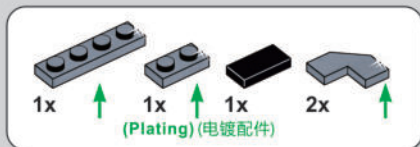

61

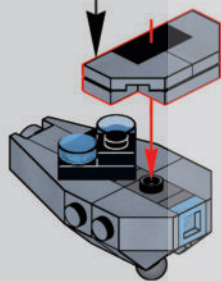
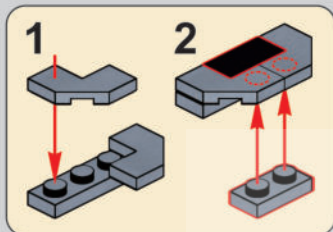

62

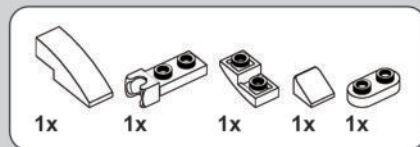
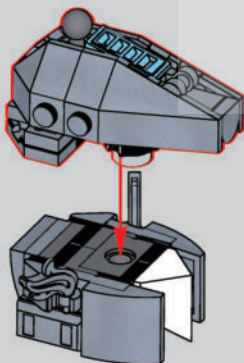

63

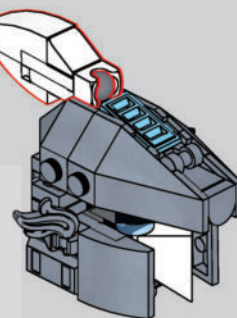
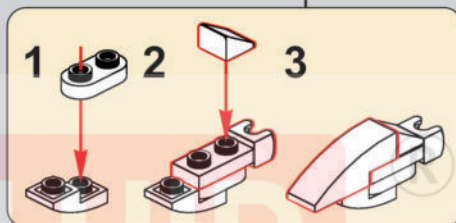

64

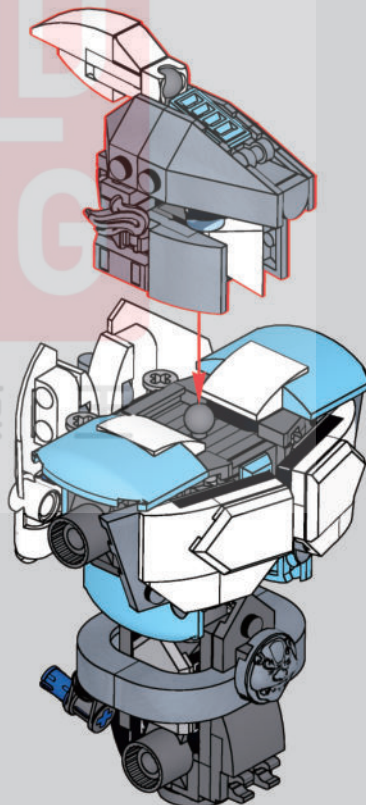

MULTI  
KING  
宇 | 星 | 模

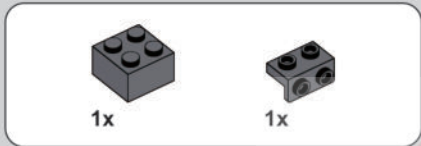
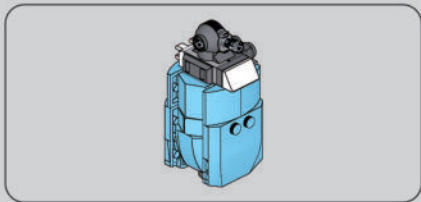

65

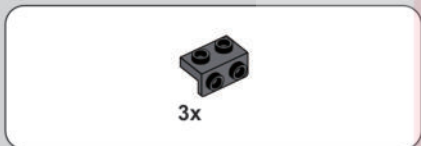
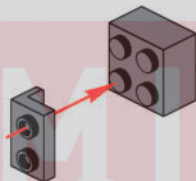

66

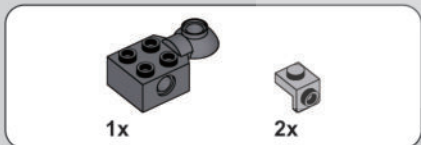
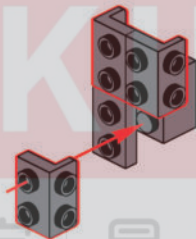

67

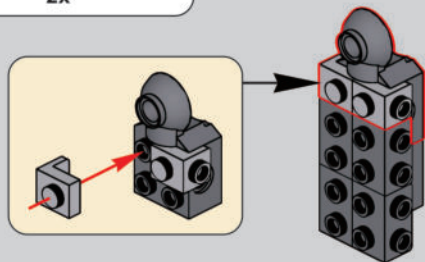

68

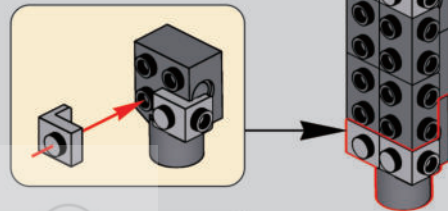

69

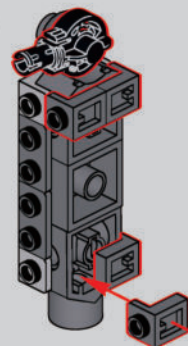

70

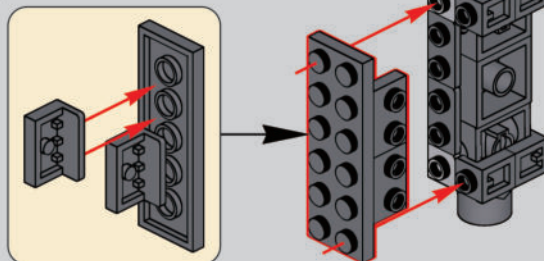

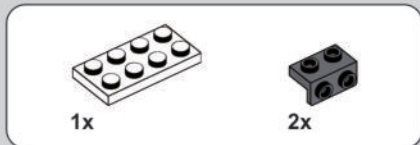

71

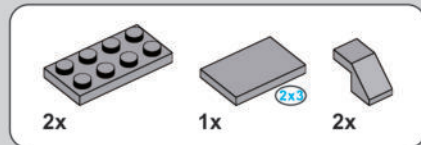
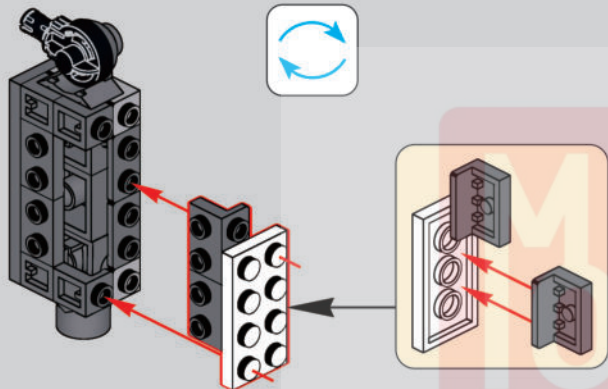

73

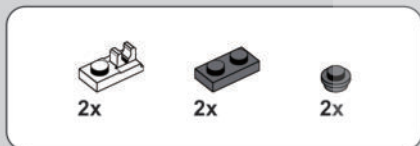
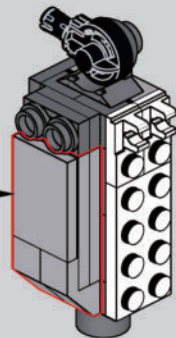
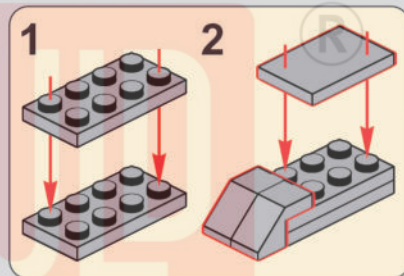

72

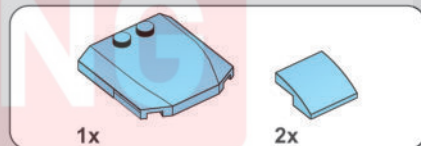
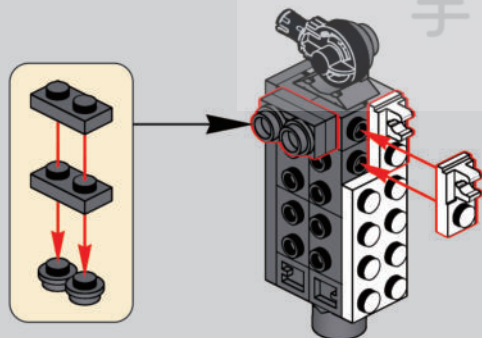

74

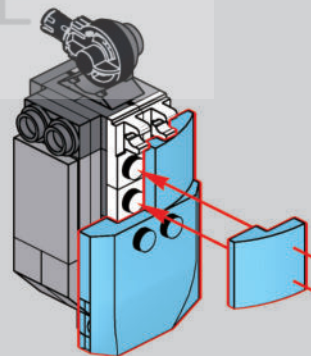

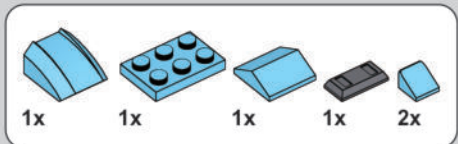

75

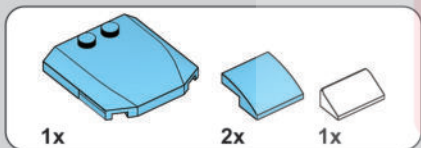
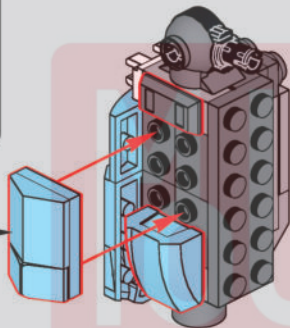
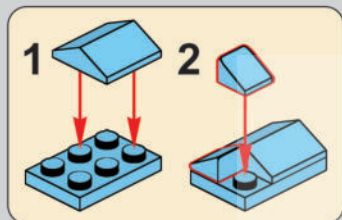

76

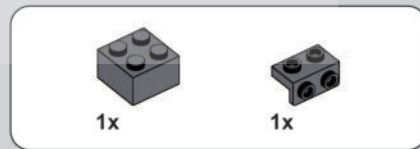
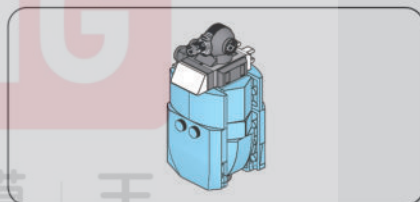
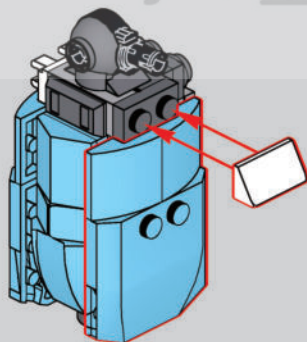

77

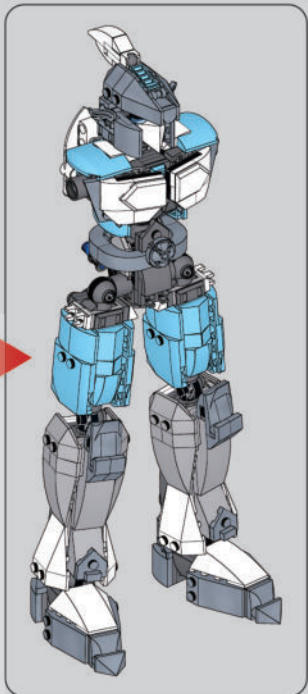
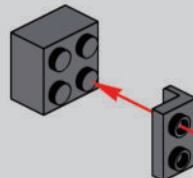

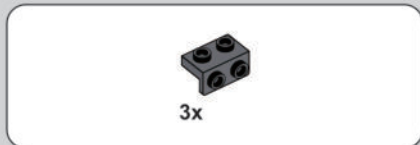

78

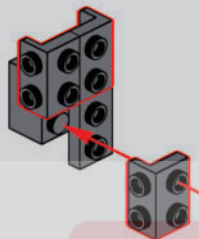

81

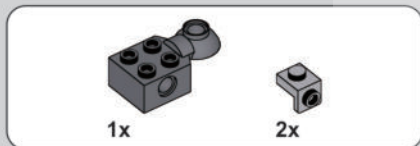
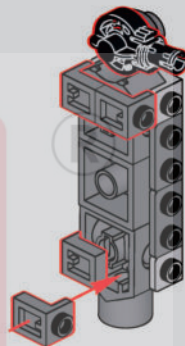

79

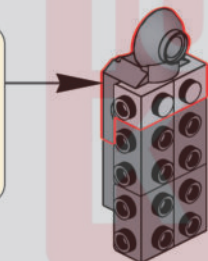
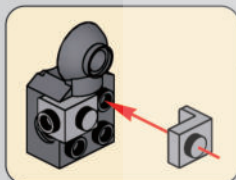

82

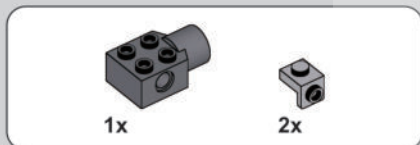

80

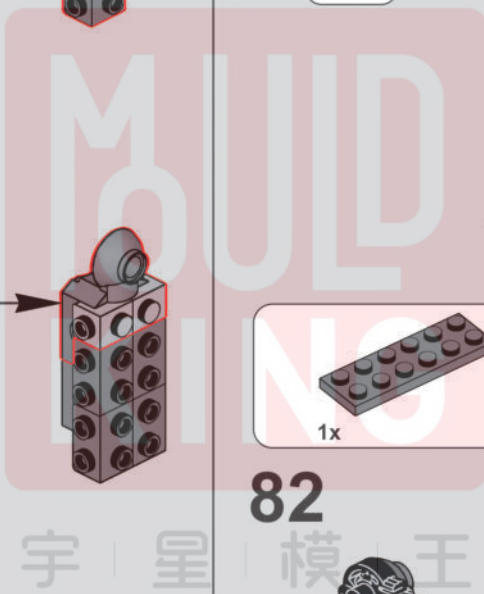
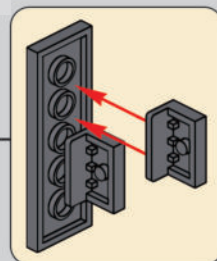
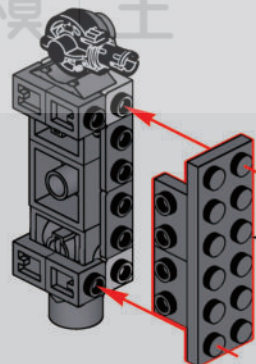
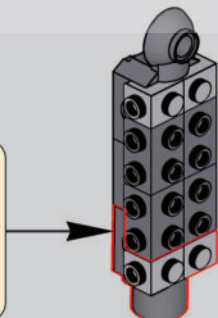
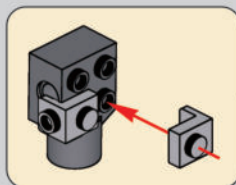

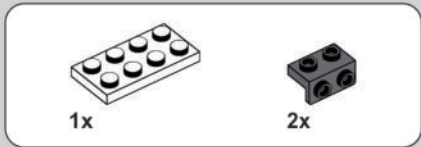

83

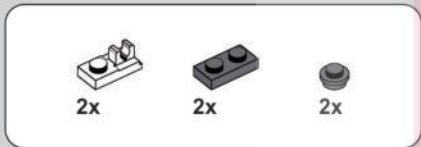
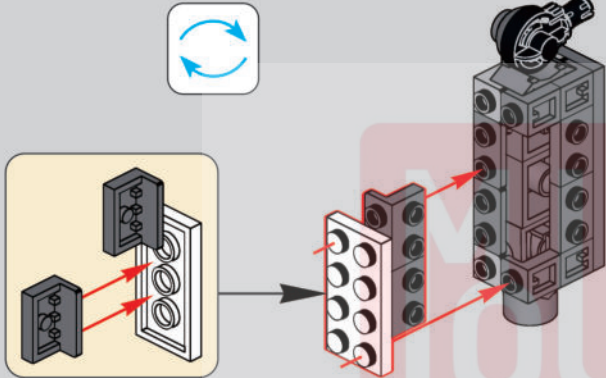

84

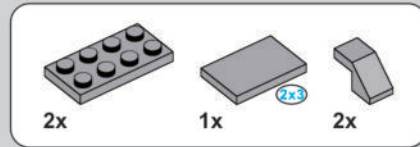
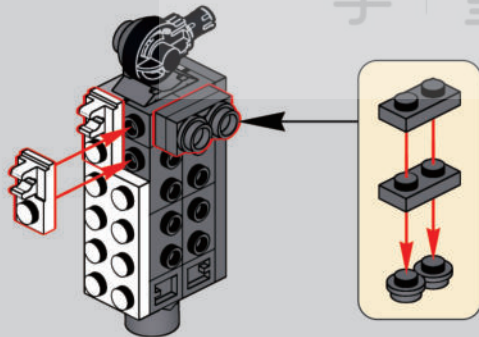

85

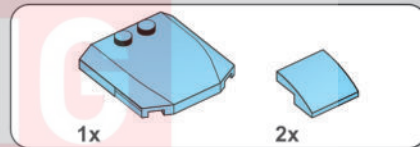
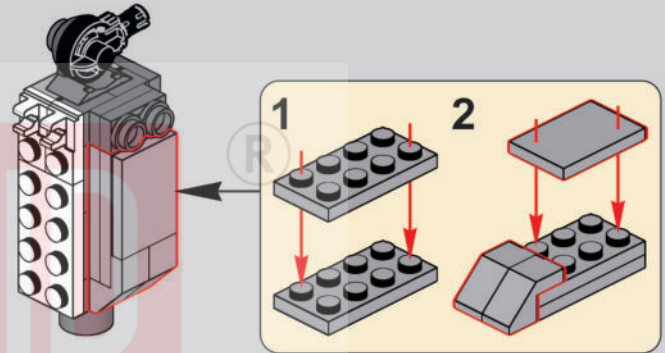

86

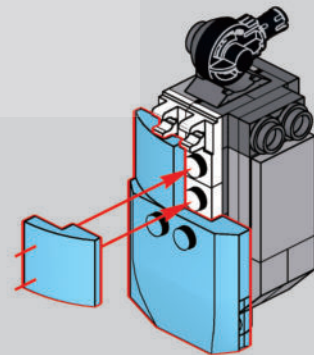

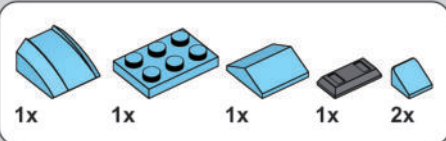

87

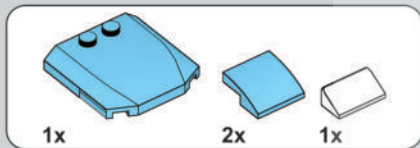
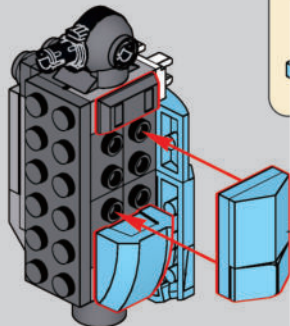
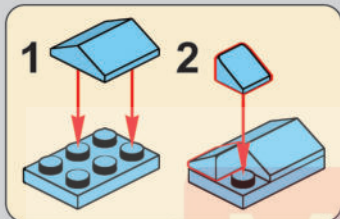

88

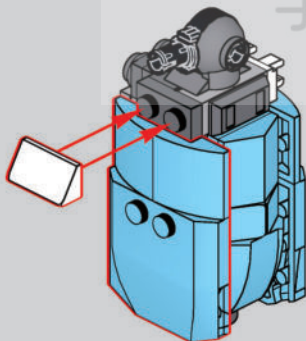

89

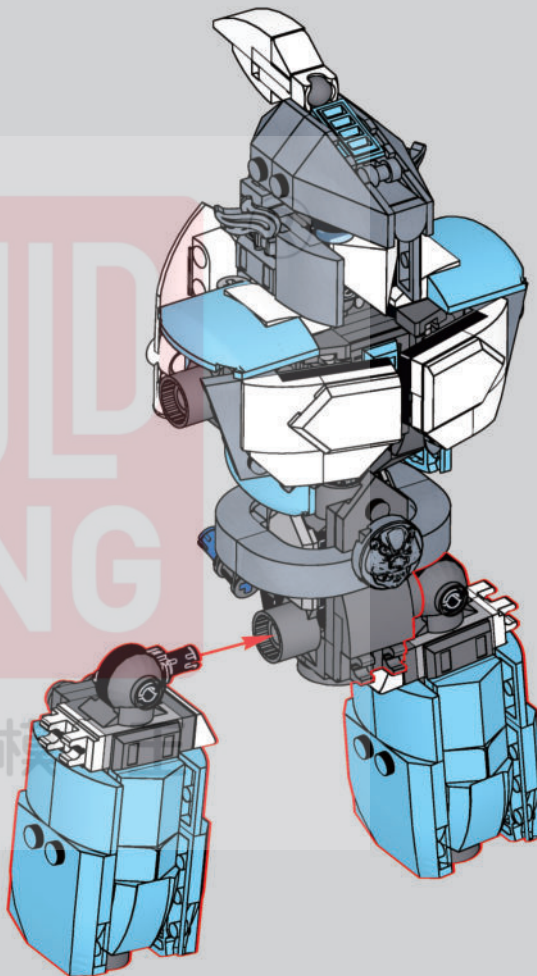



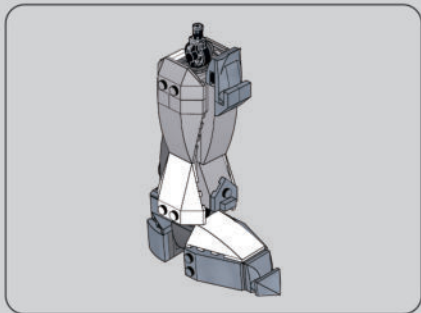

90

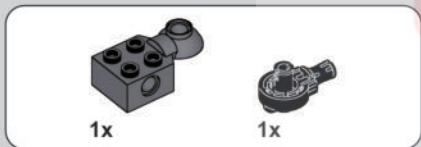
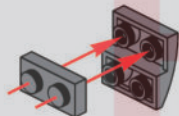

91

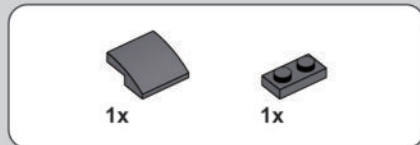
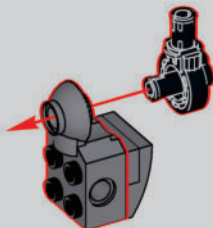

92

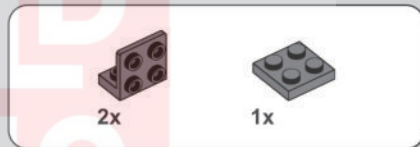
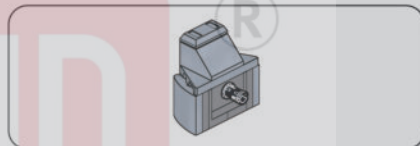
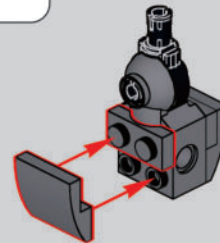

93

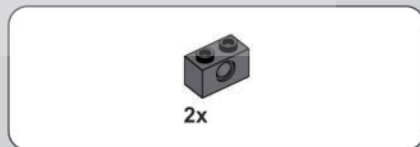
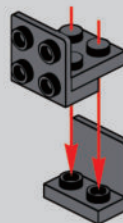

94

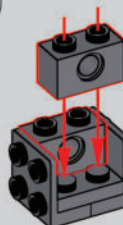

MOULD KING  
宇 | 星 | 模 | 王



95

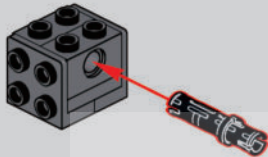

96

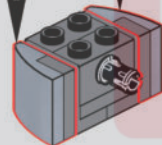
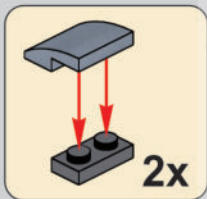

97

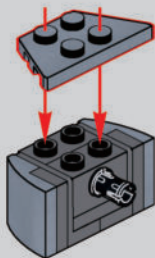

98

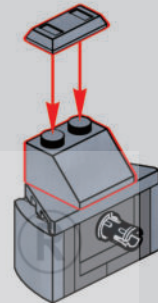

99

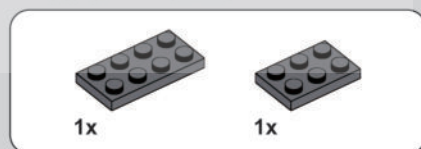
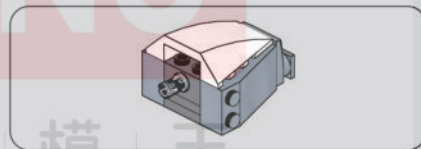
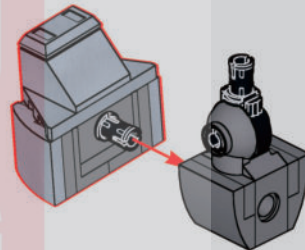

100

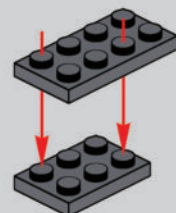

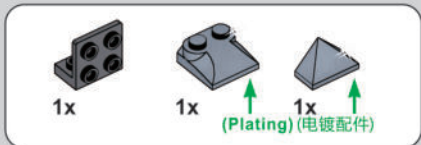

101

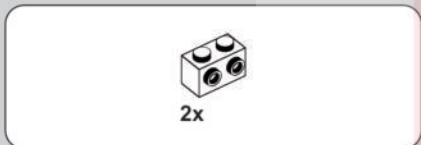
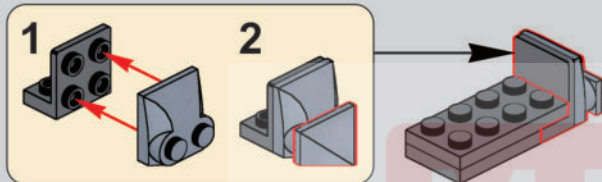

102

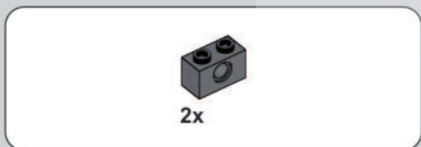
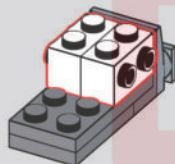

103

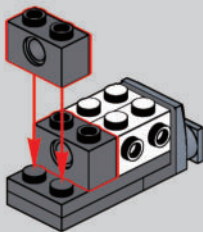

104

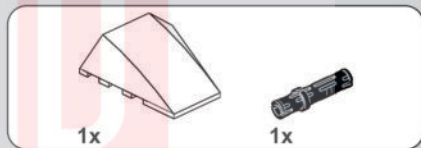
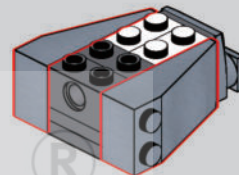

105

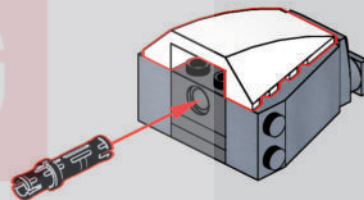

106

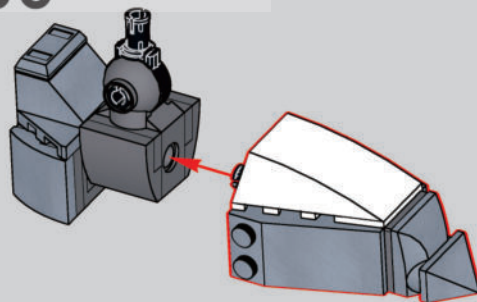

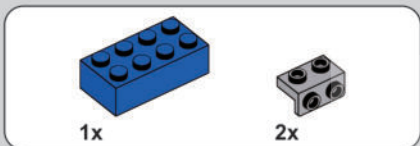
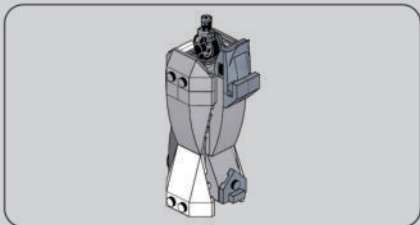

107

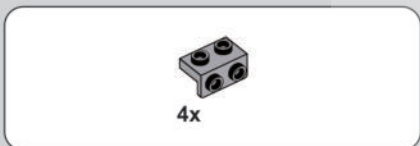
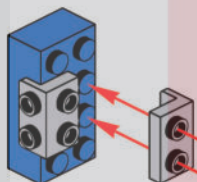

108

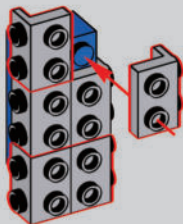

109

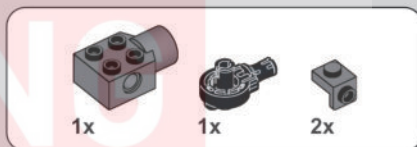
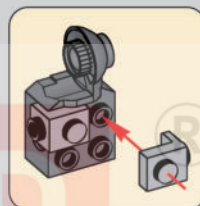

110

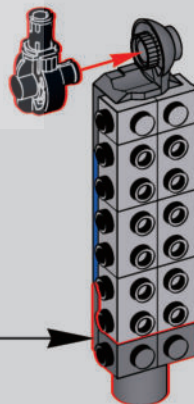
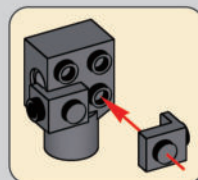



6x



4x

# 111

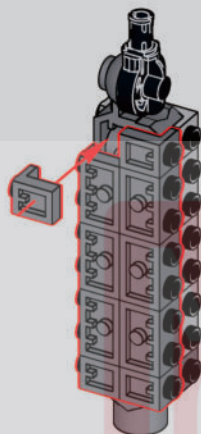

1x



2x



1x



2x

# 112

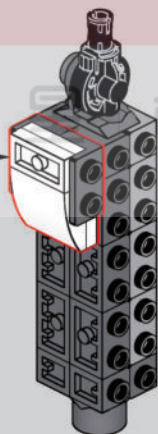
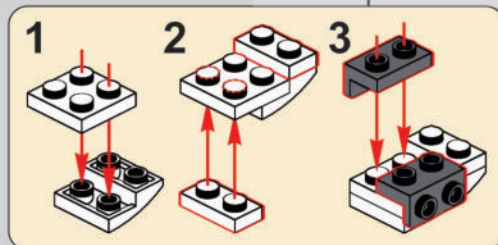

2x



1x

# 113

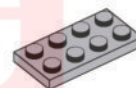
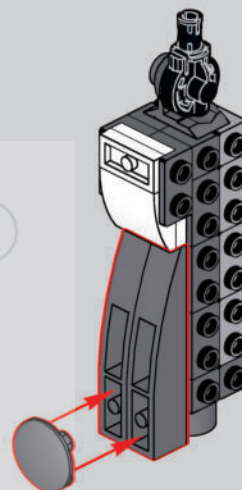

1x



2x

# 114

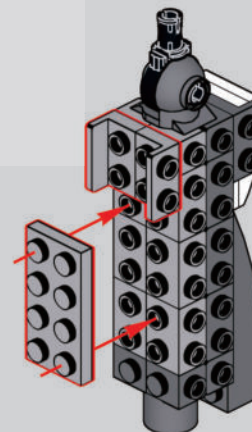

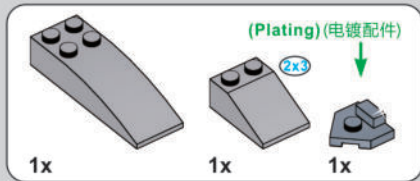

115

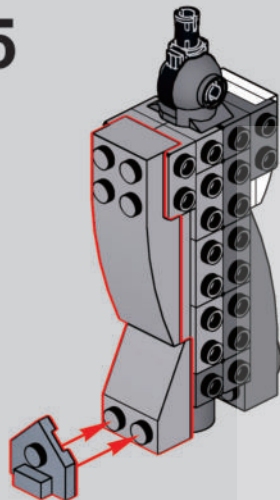

116

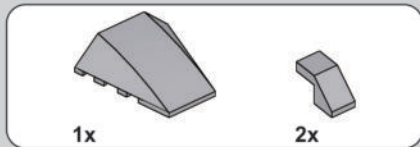
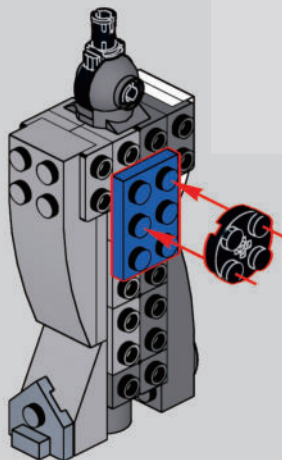

117

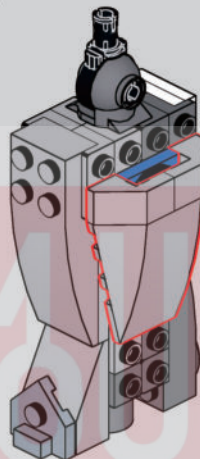

118

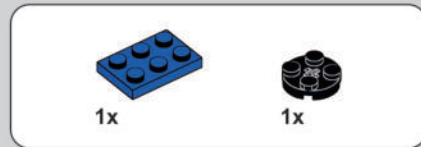
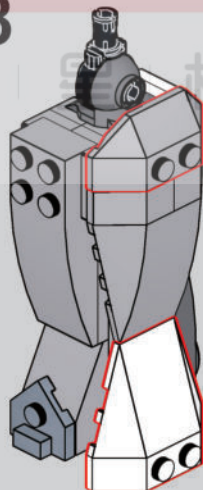

119

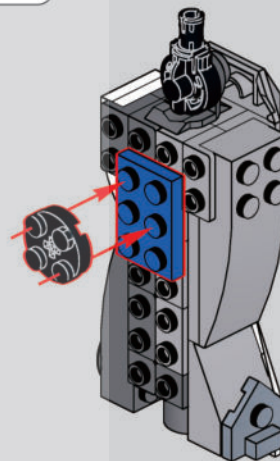

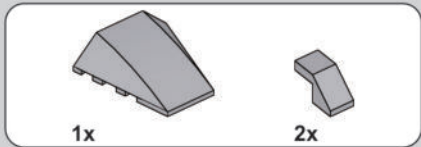

120

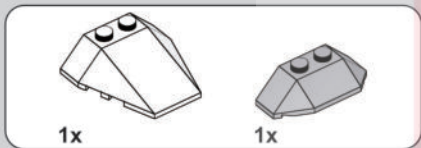
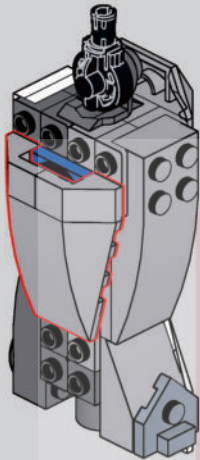

121

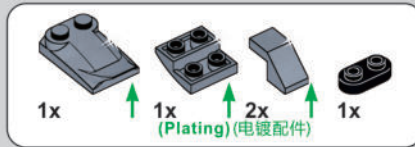
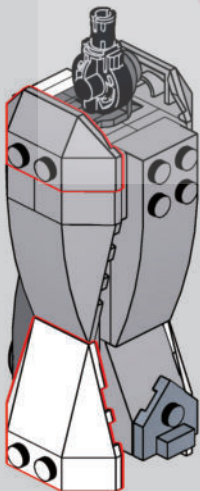

122

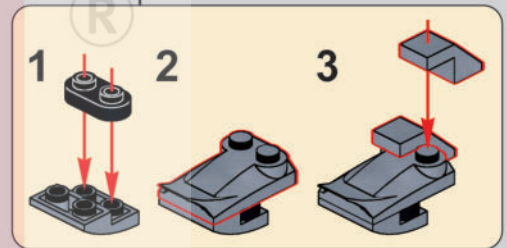
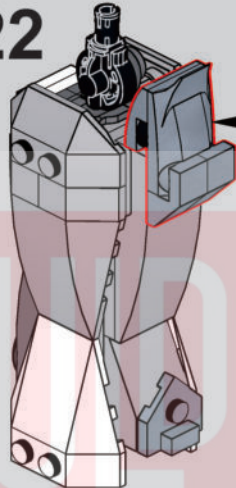

123

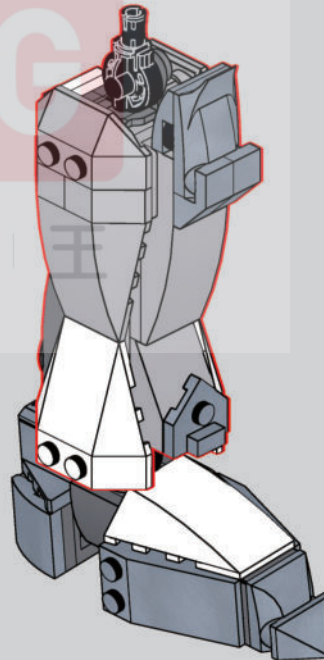

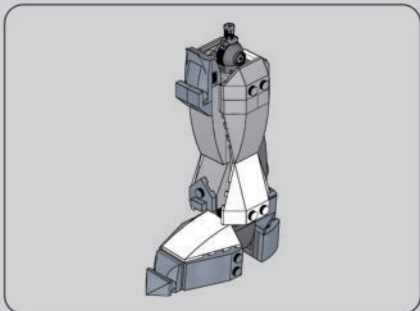

124

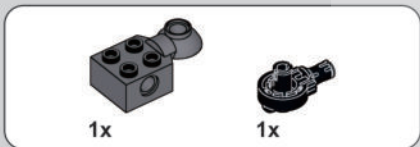
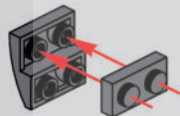

125

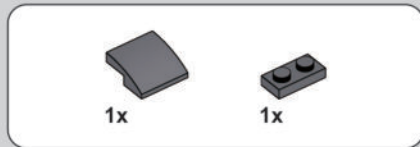
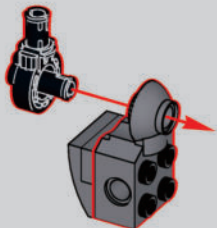

126

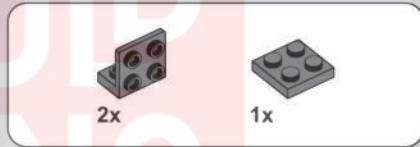
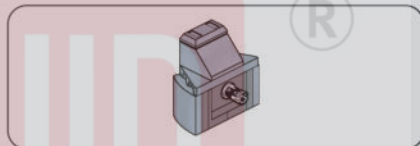
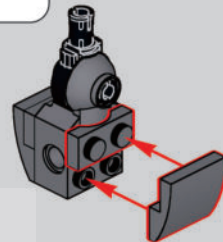

127

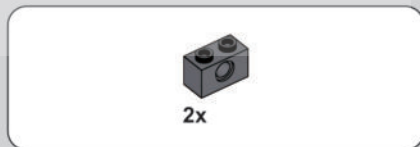
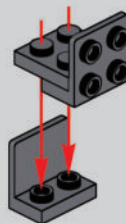

128

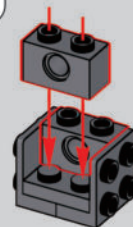





1x

# 129

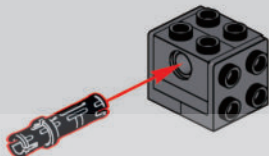

2x  
(Plating) (电镀配件)

2x

# 130

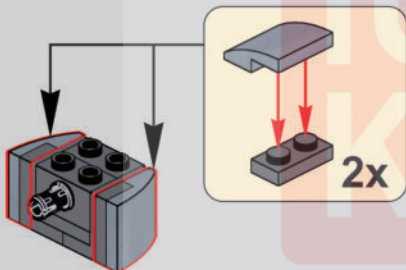

2x



1x  
(Plating) (电镀配件)

# 131

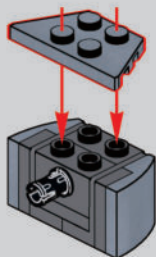

1x

(Plating) (电镀配件)



1x

# 132

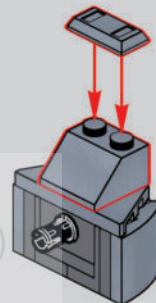

# 133

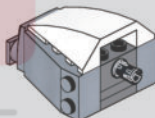
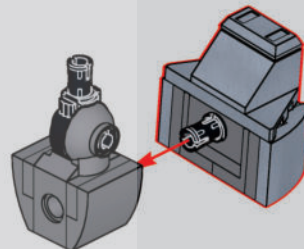

1x



1x

# 134

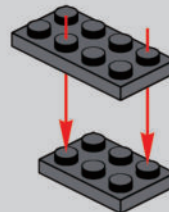

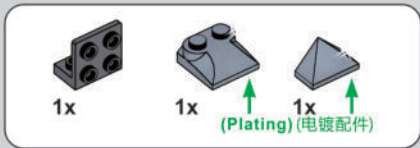

135

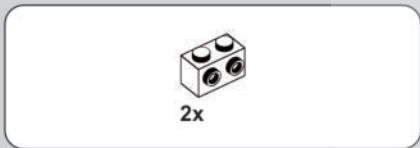
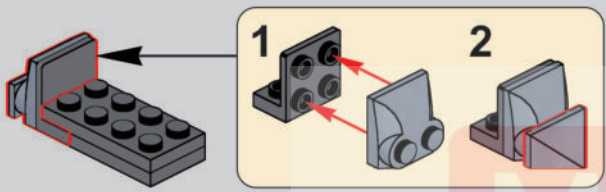

136

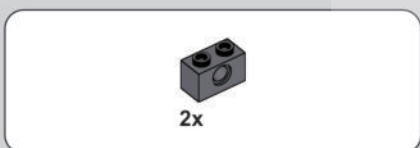
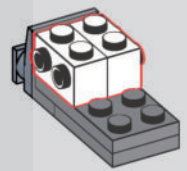

137

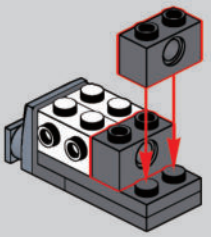

138

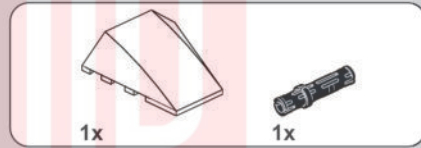
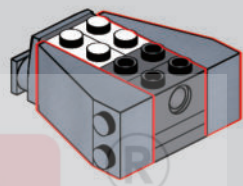

139

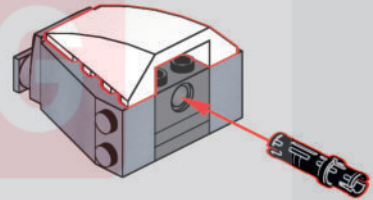

140

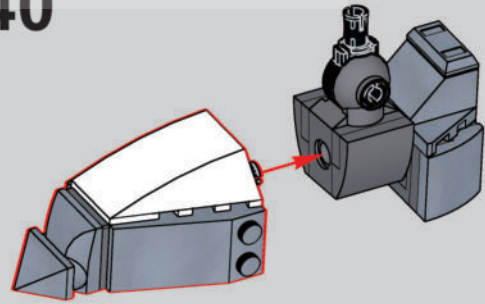

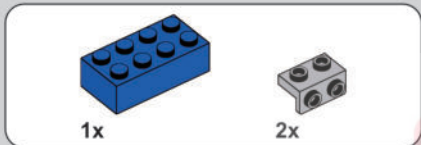
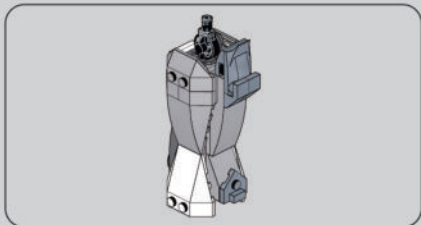

141

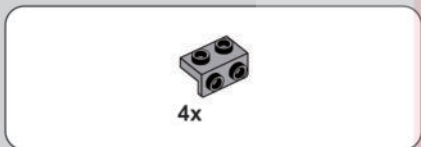
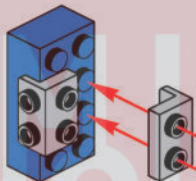

142

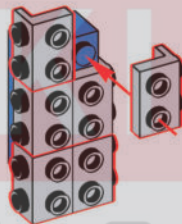

143

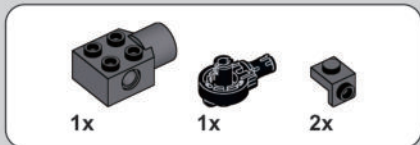
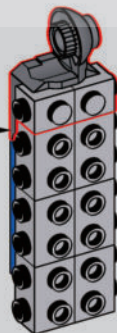
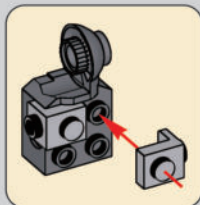

144

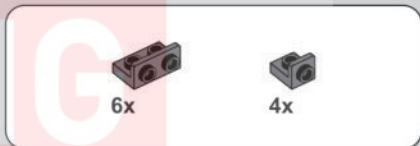
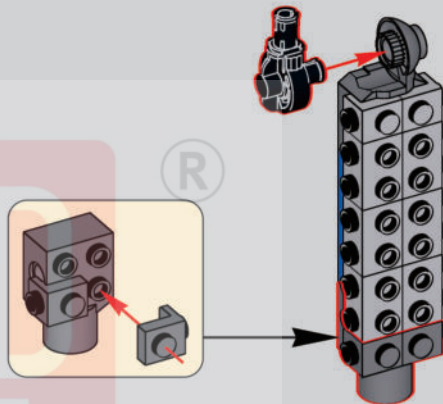

145

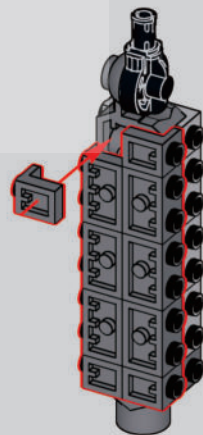

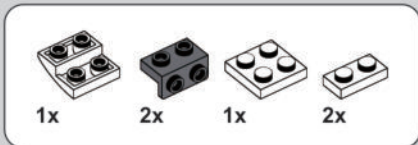

146

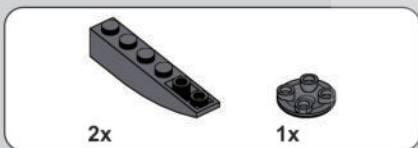
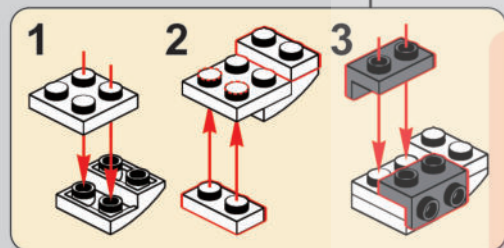

147

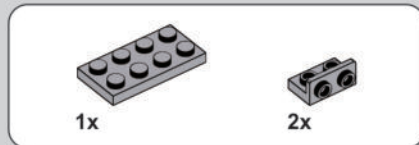
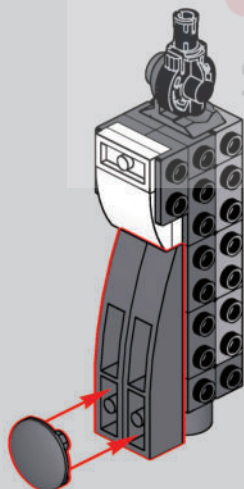

148

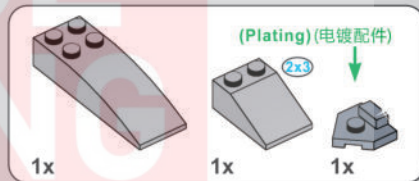
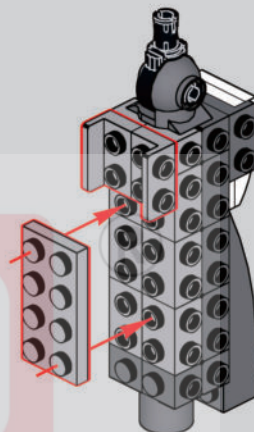

149

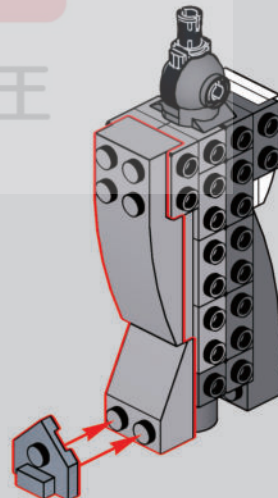

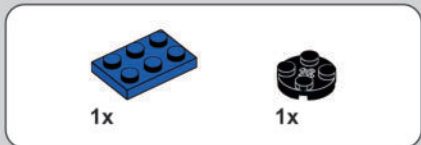

150

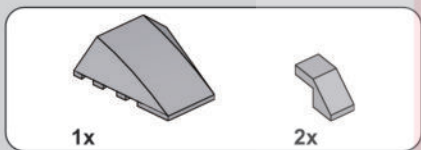
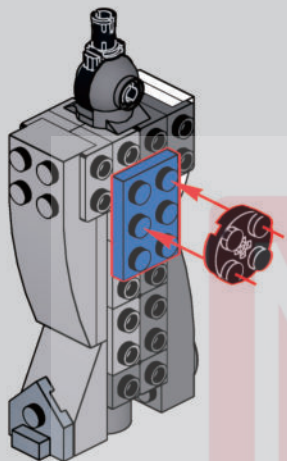

151

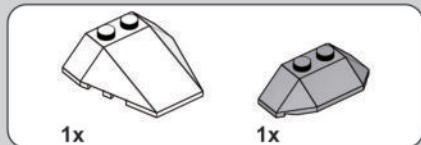
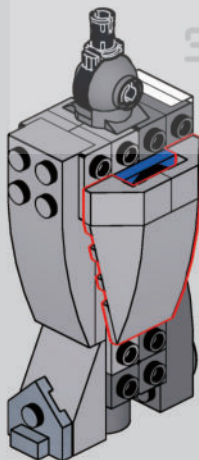

152

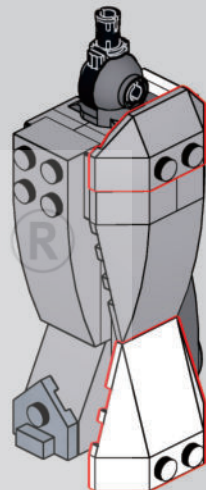

153

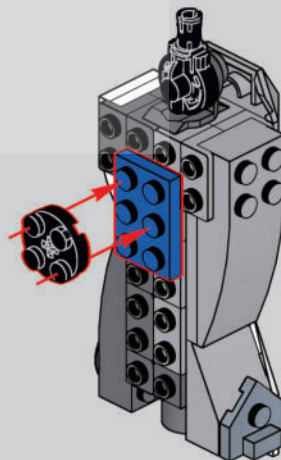

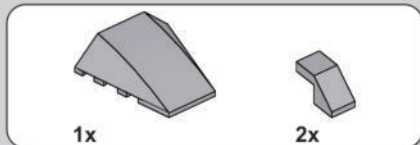

154

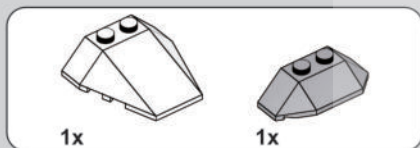
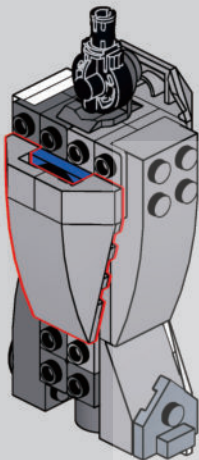

155

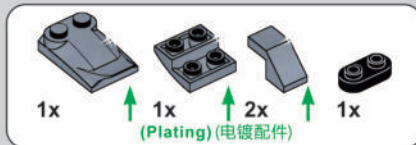
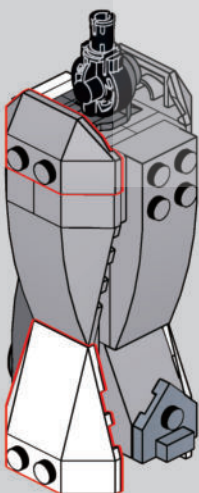

156

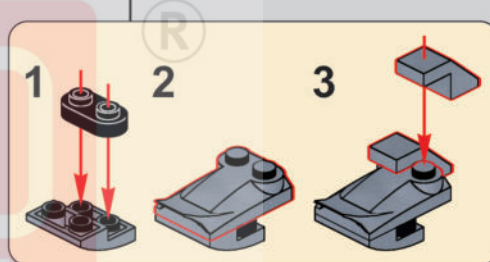
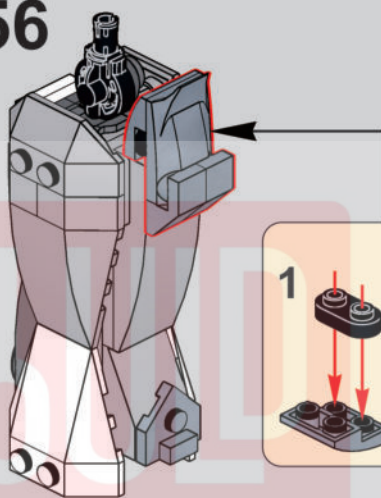

157

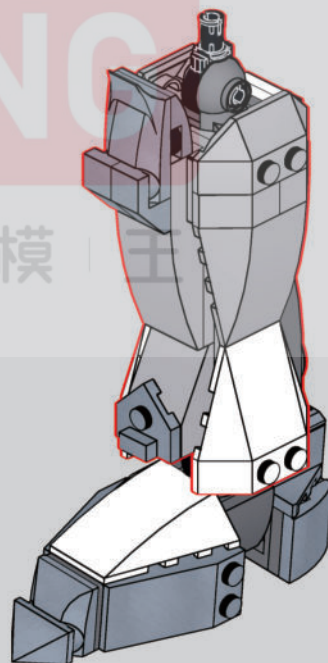

158

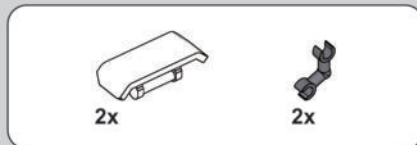
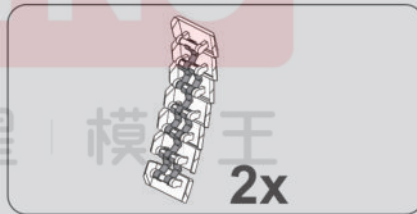
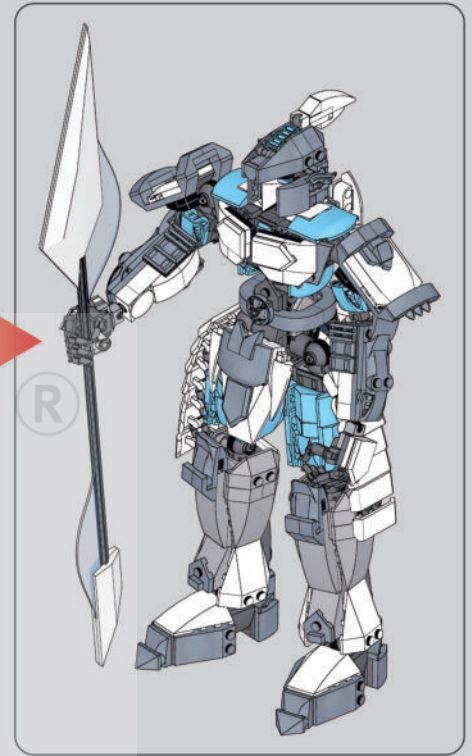
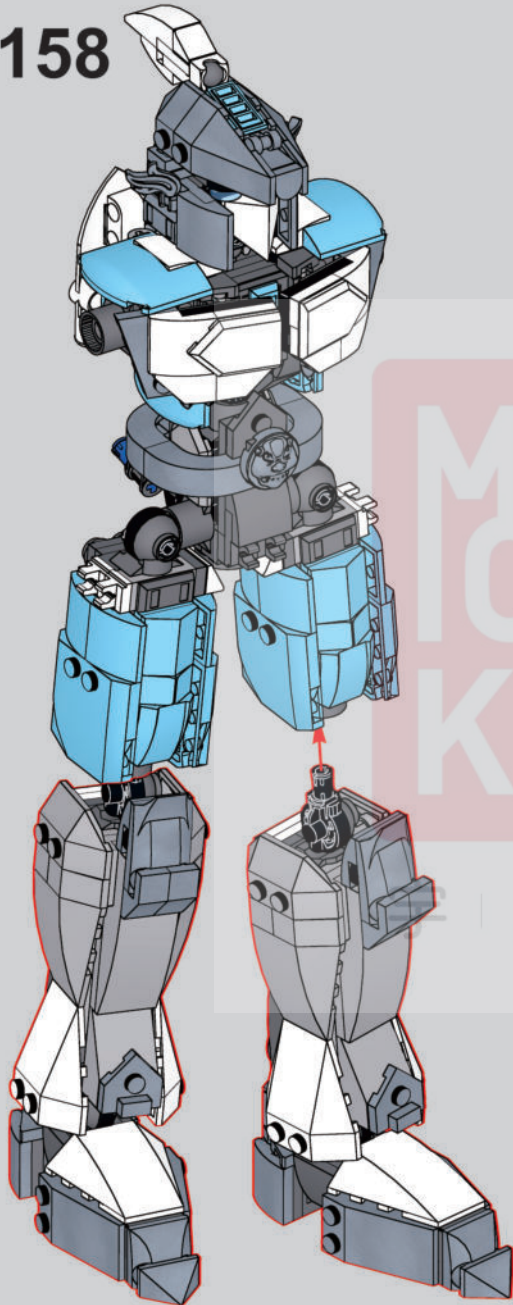

159

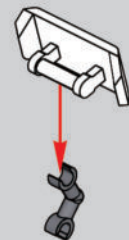

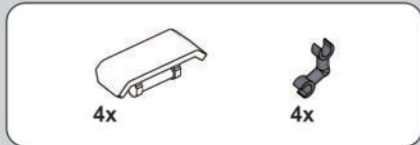

160

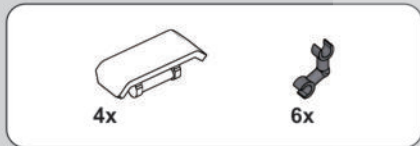
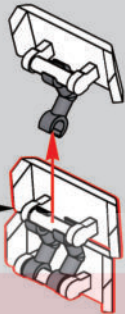
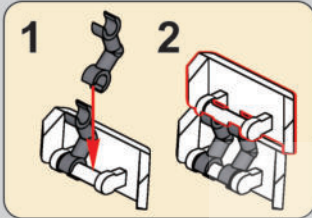

161

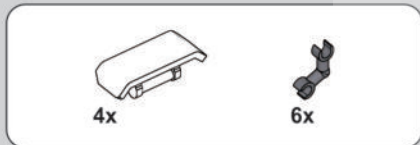
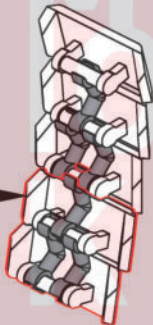
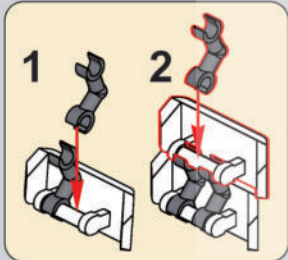

162

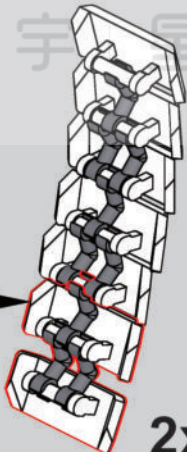
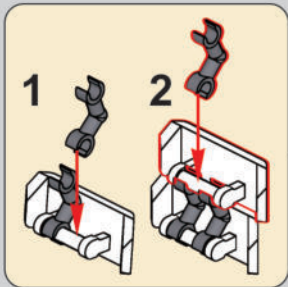

163

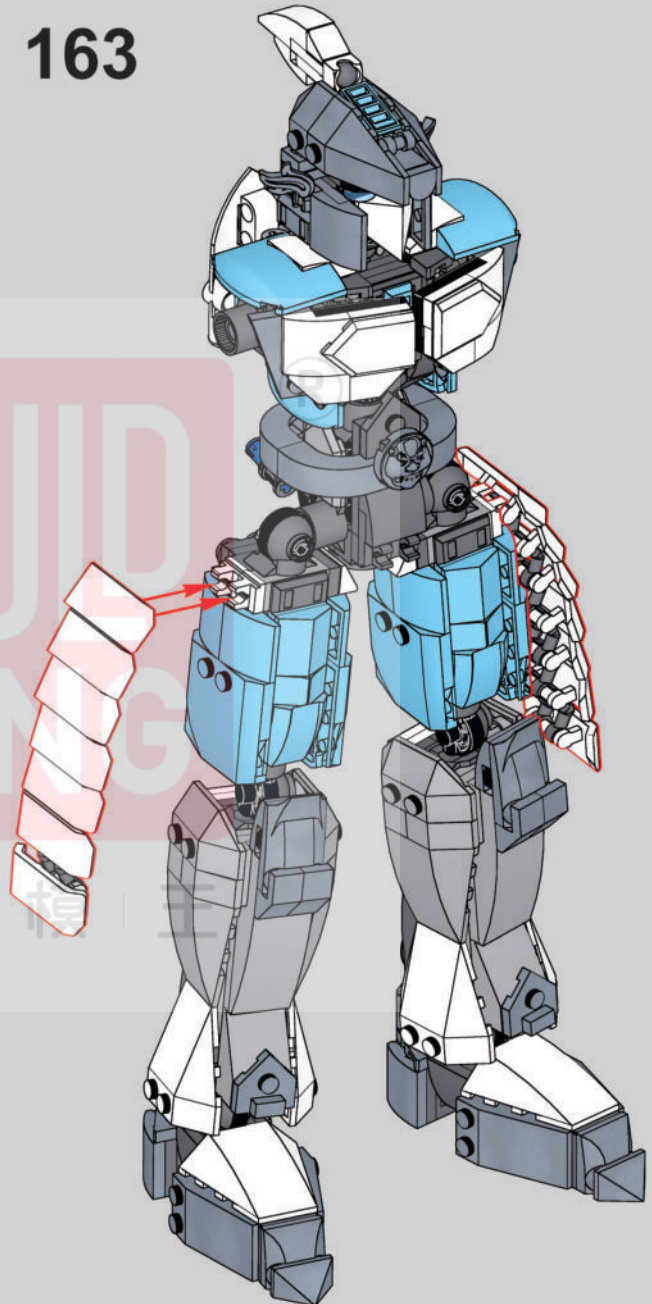



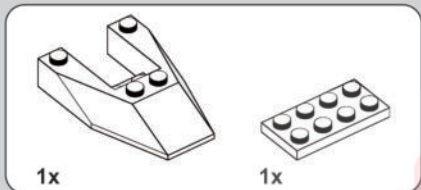
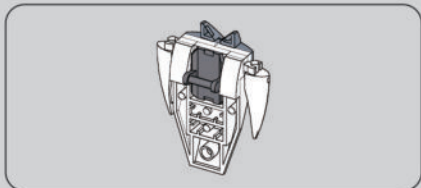

164

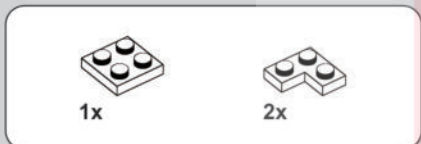
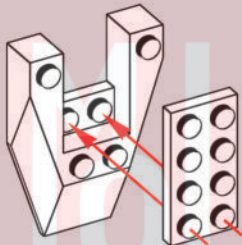

165

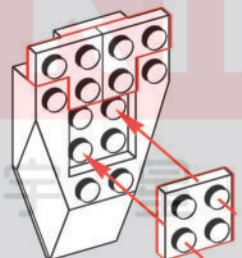

166

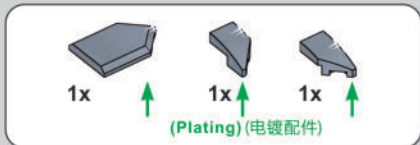
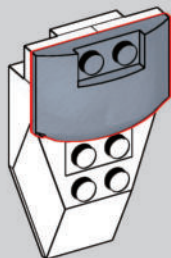

167

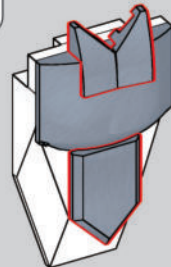

168

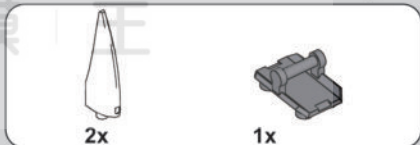
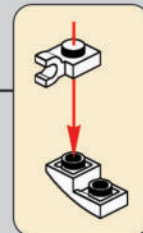
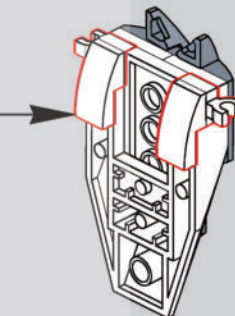
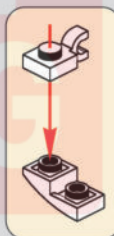

169

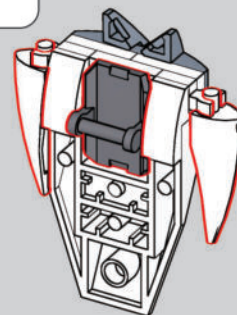

170

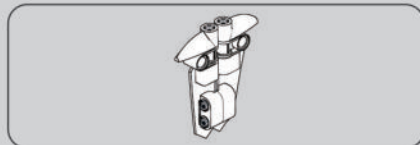
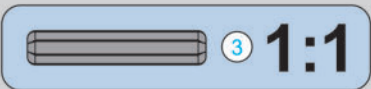
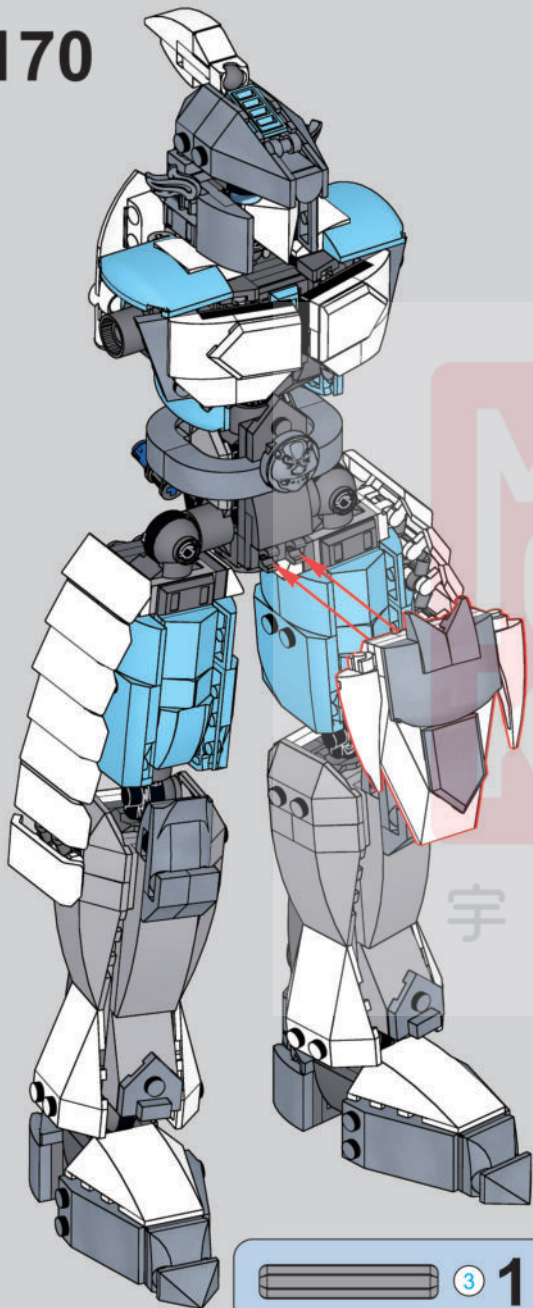

171

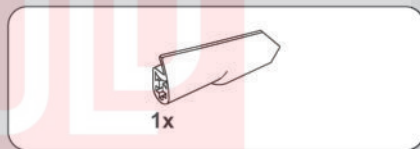

172



173

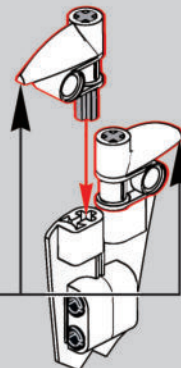
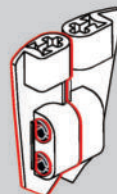
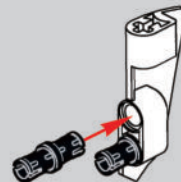
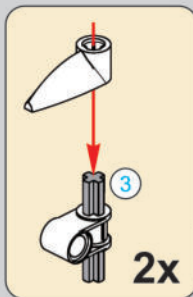

174

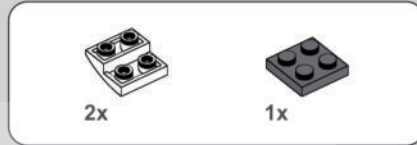
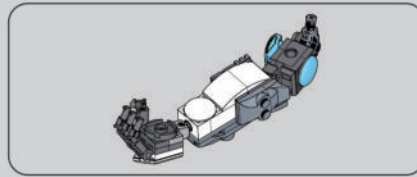
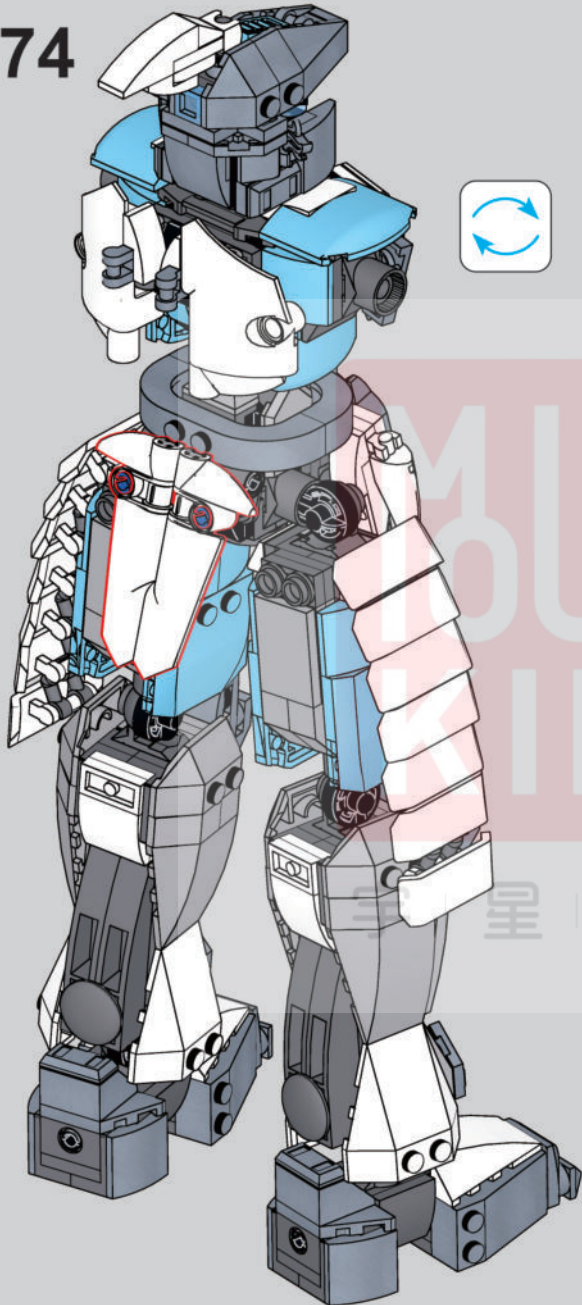

175

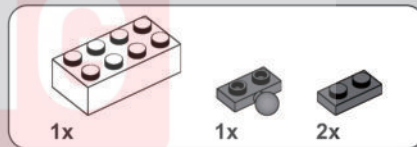
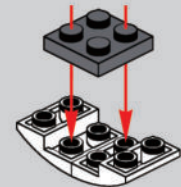

176

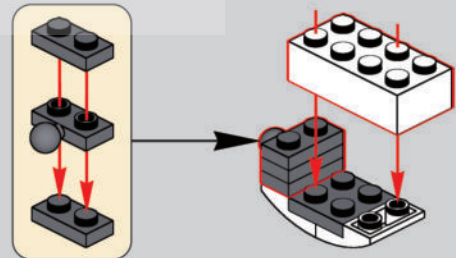

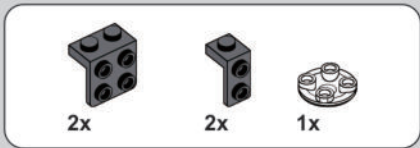

177

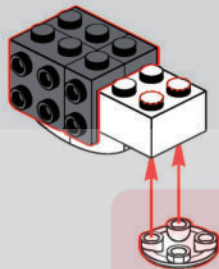

178

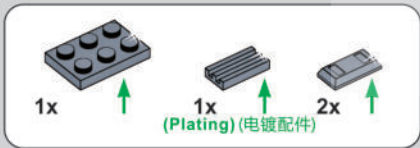
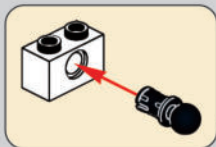
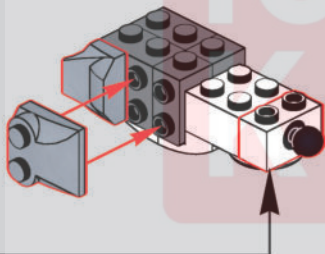

179

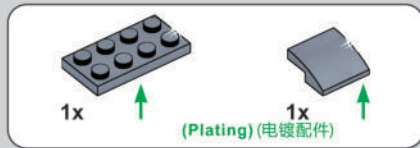
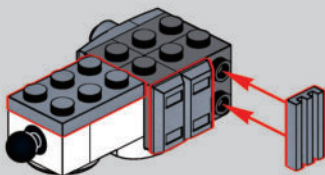

180

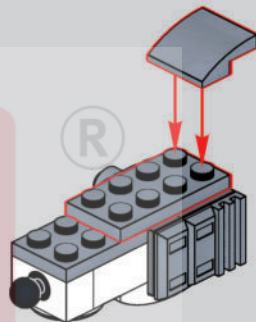

181

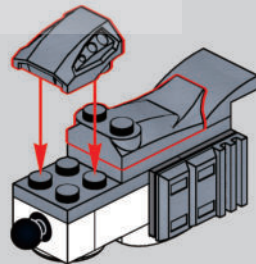

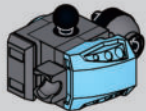

182

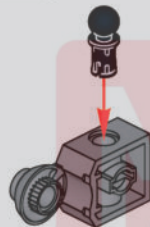

183

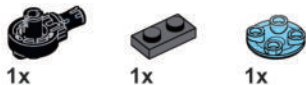
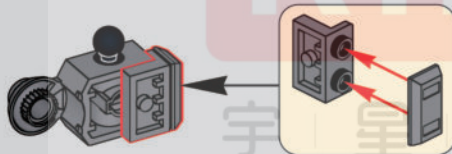

184

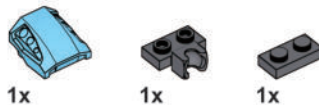
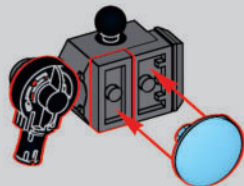

185

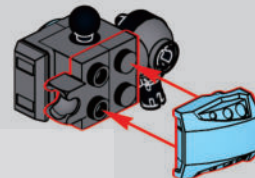

186

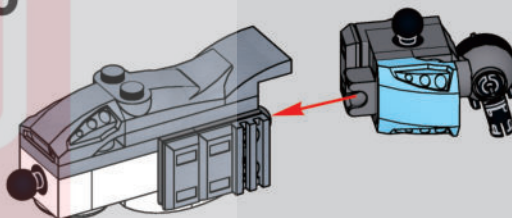

187

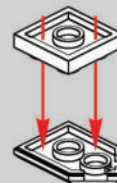

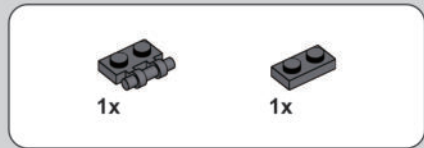

188

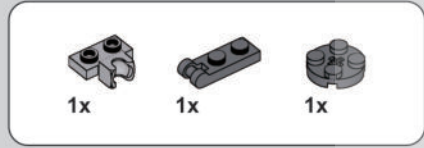

189

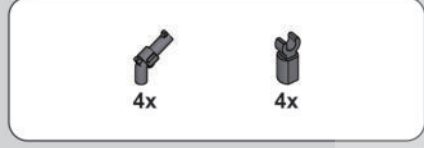
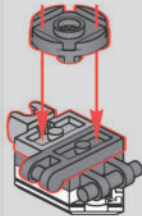

190

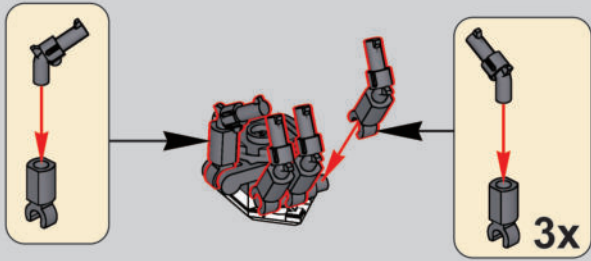

191

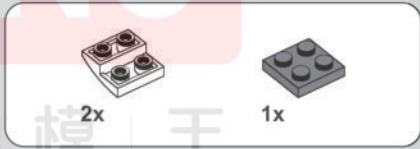
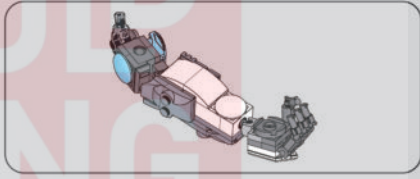
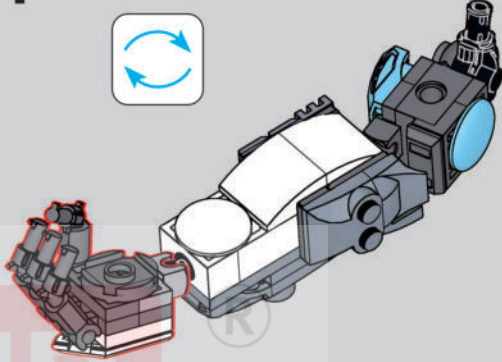

192

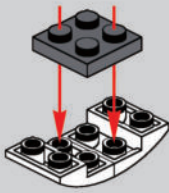

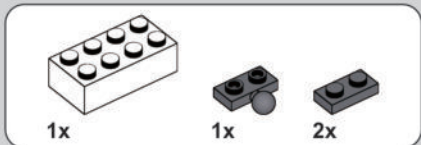

193

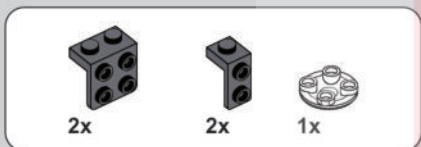
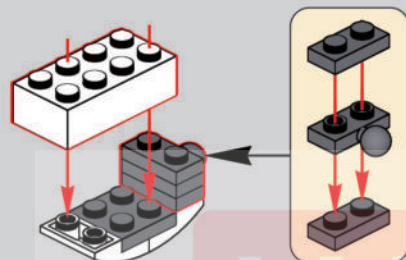

194

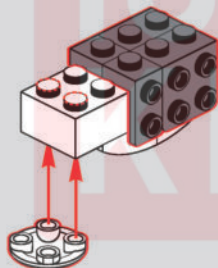

195

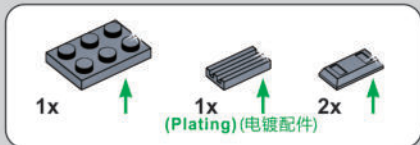
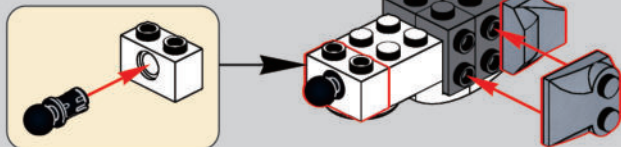

196

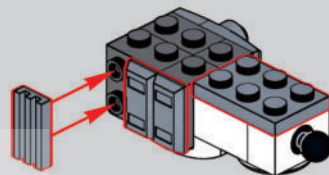

197

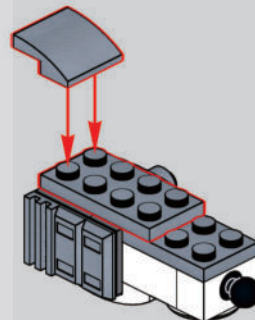

198

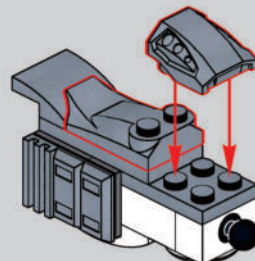

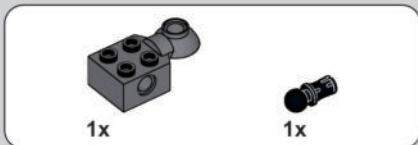
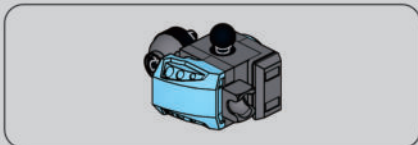

199

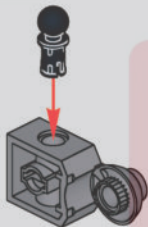

200

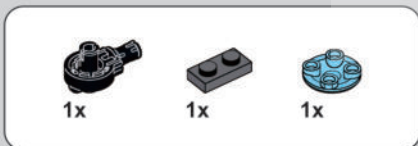
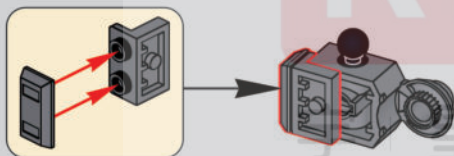

201

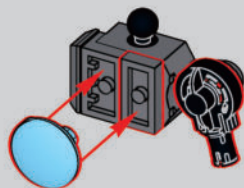

202

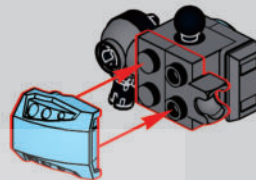

203

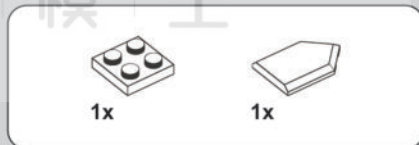
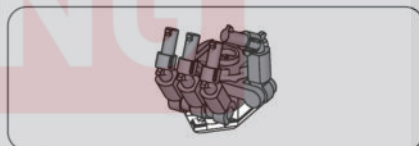
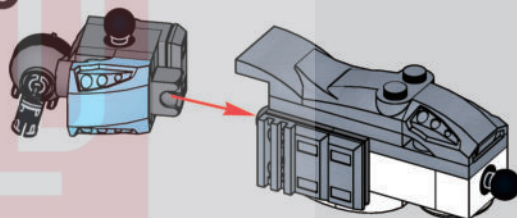

204

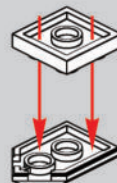





1x



1x

# 205



1x



1x



1x

# 206

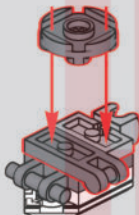

4x



4x

# 207

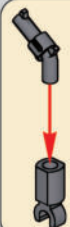

3x

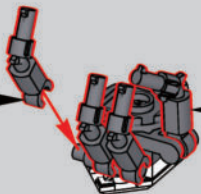

# 208

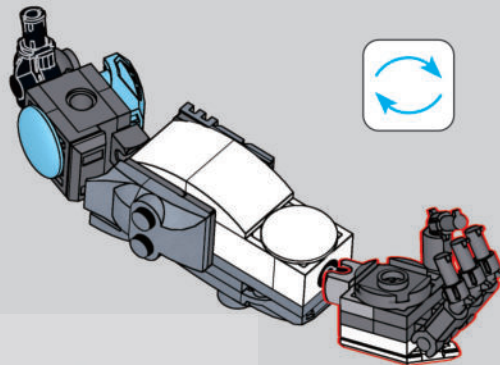

# 209

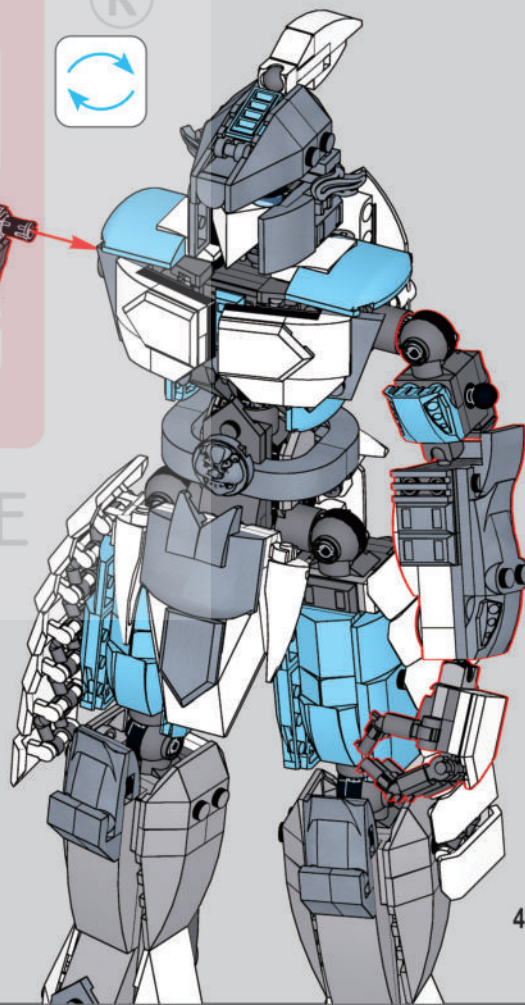
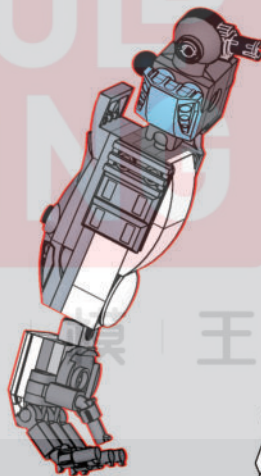

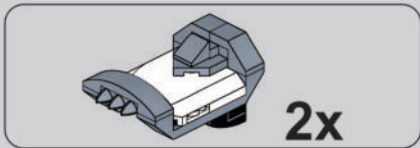

210

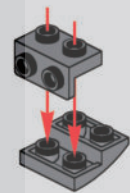

211

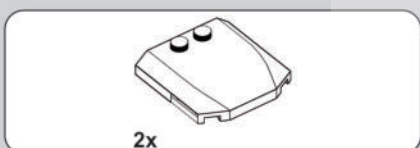
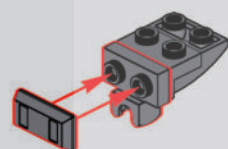

212

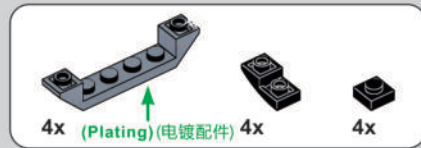
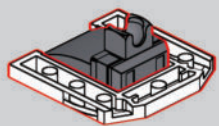

213

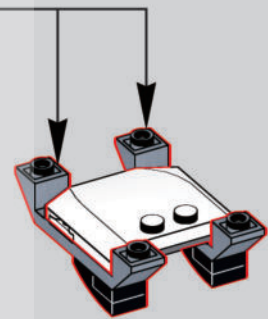
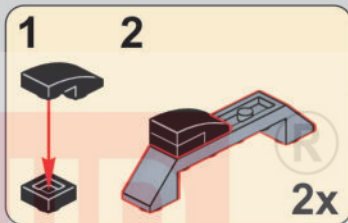

214

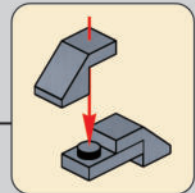
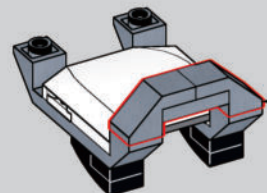



2x



(Plating) (电镀配件)



2x



# 215

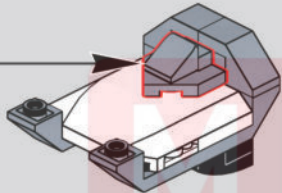
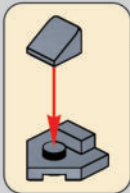

2x



(Plating) (电镀配件)



2x



# 216

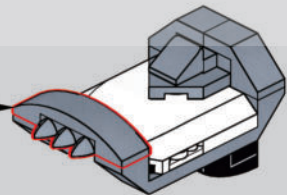

2x

# 217

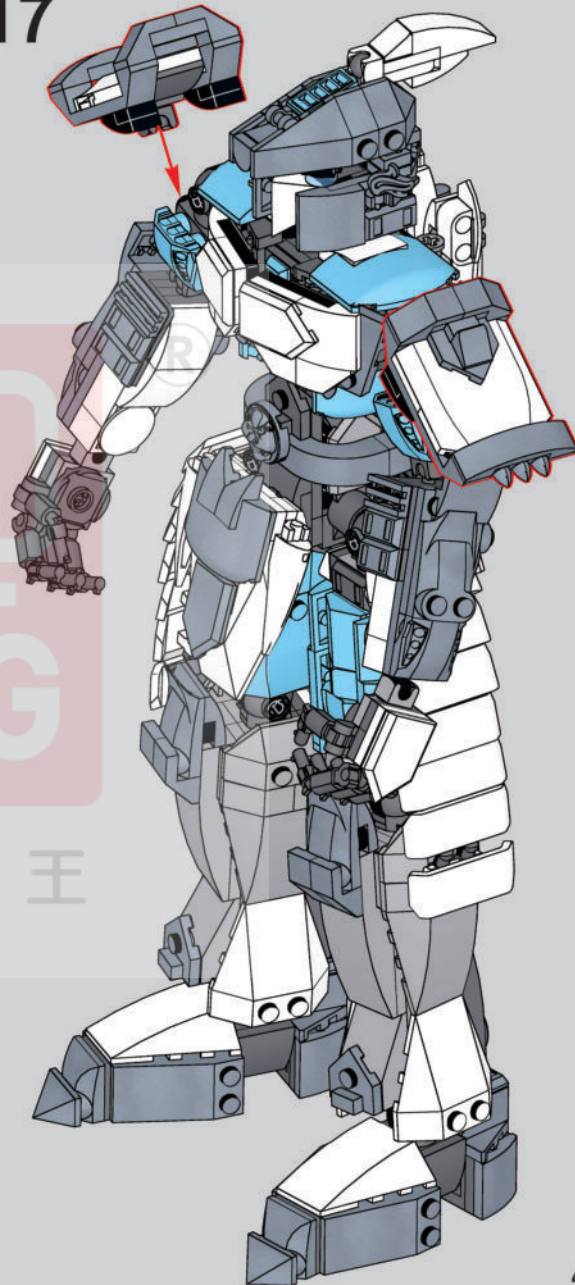
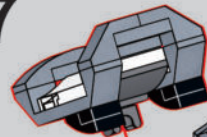

宇 | 星 | 模 | 王

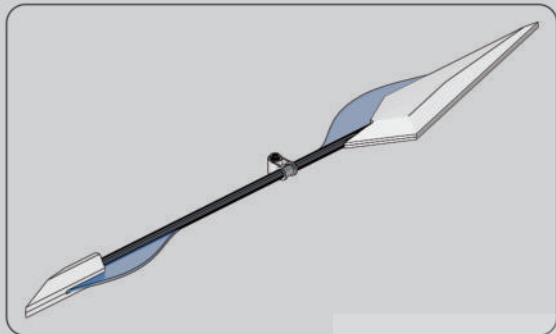

218



219

宇 | 星 | 模 | 王



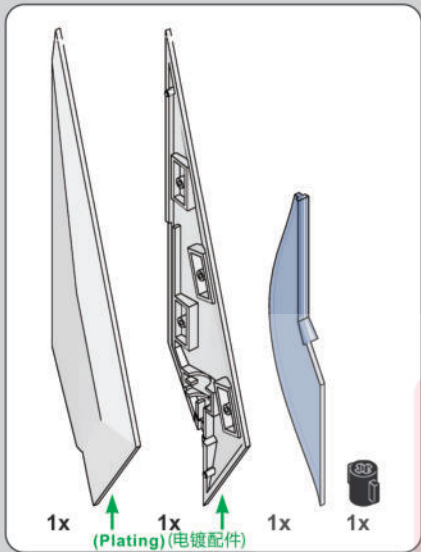

220

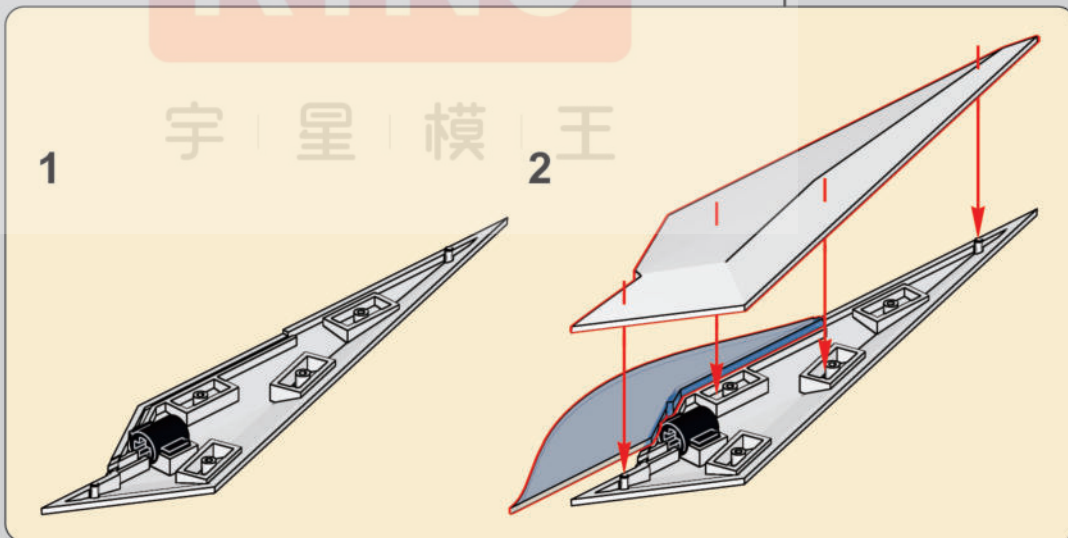
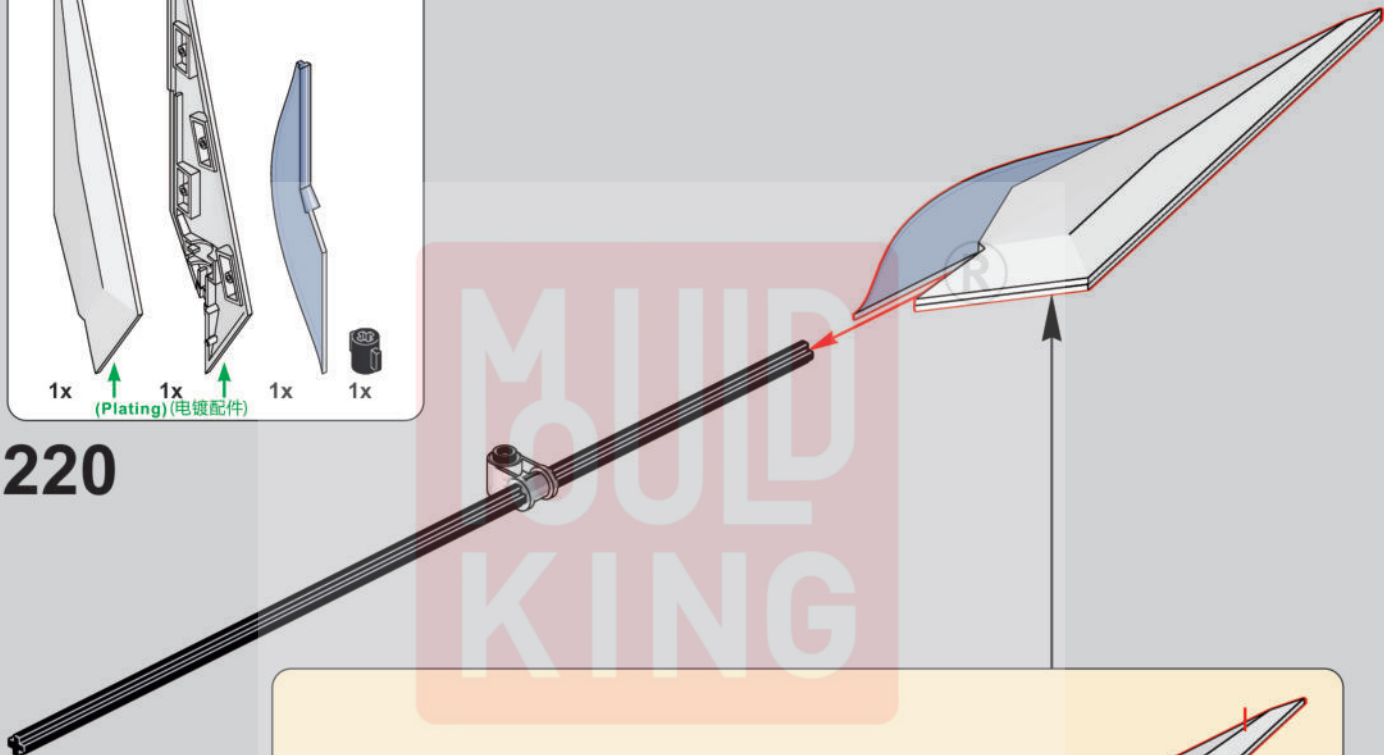

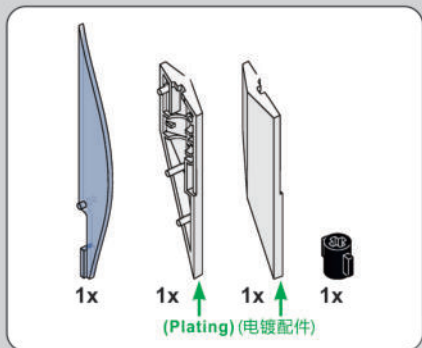

221

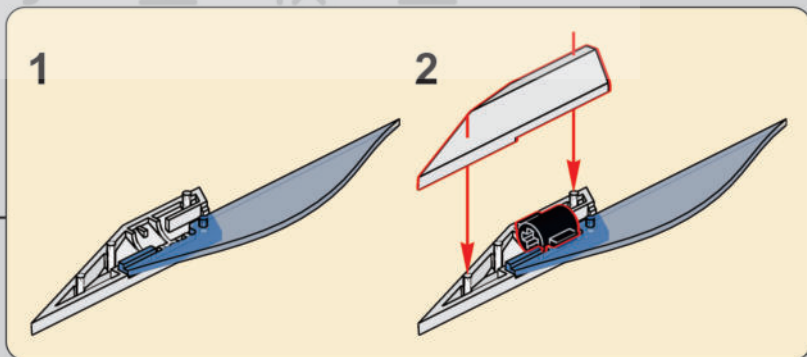
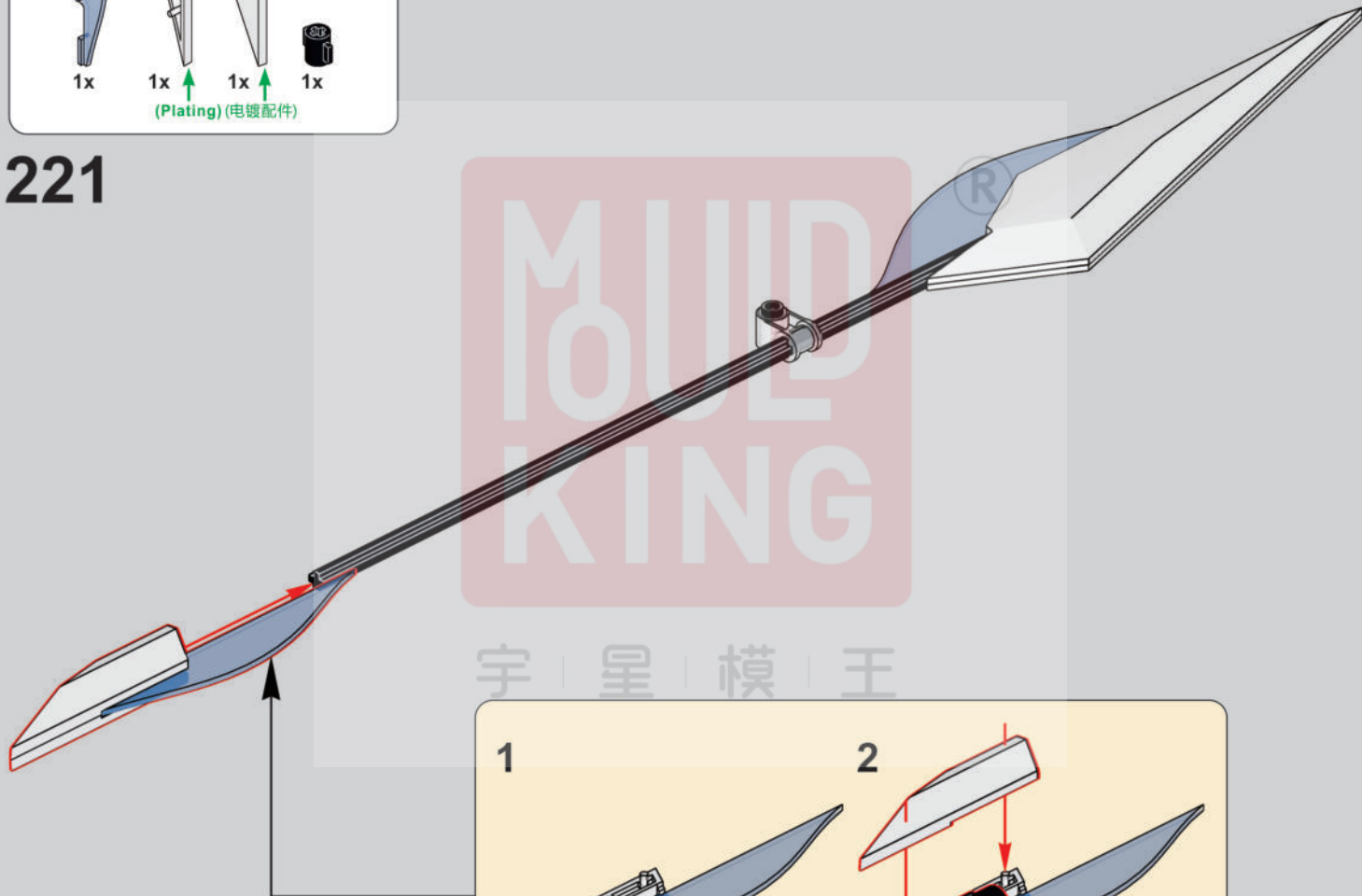

222

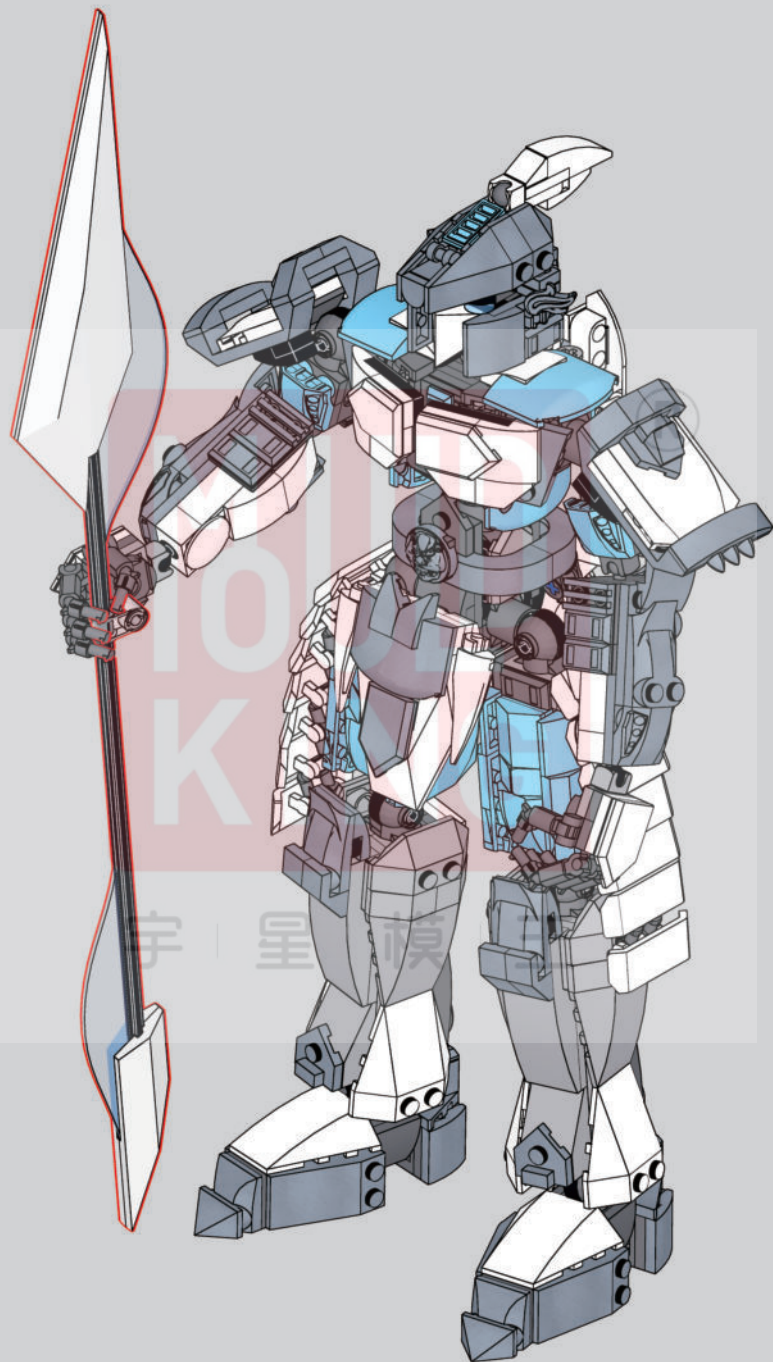



®

宇 | 星 | 模 | 王

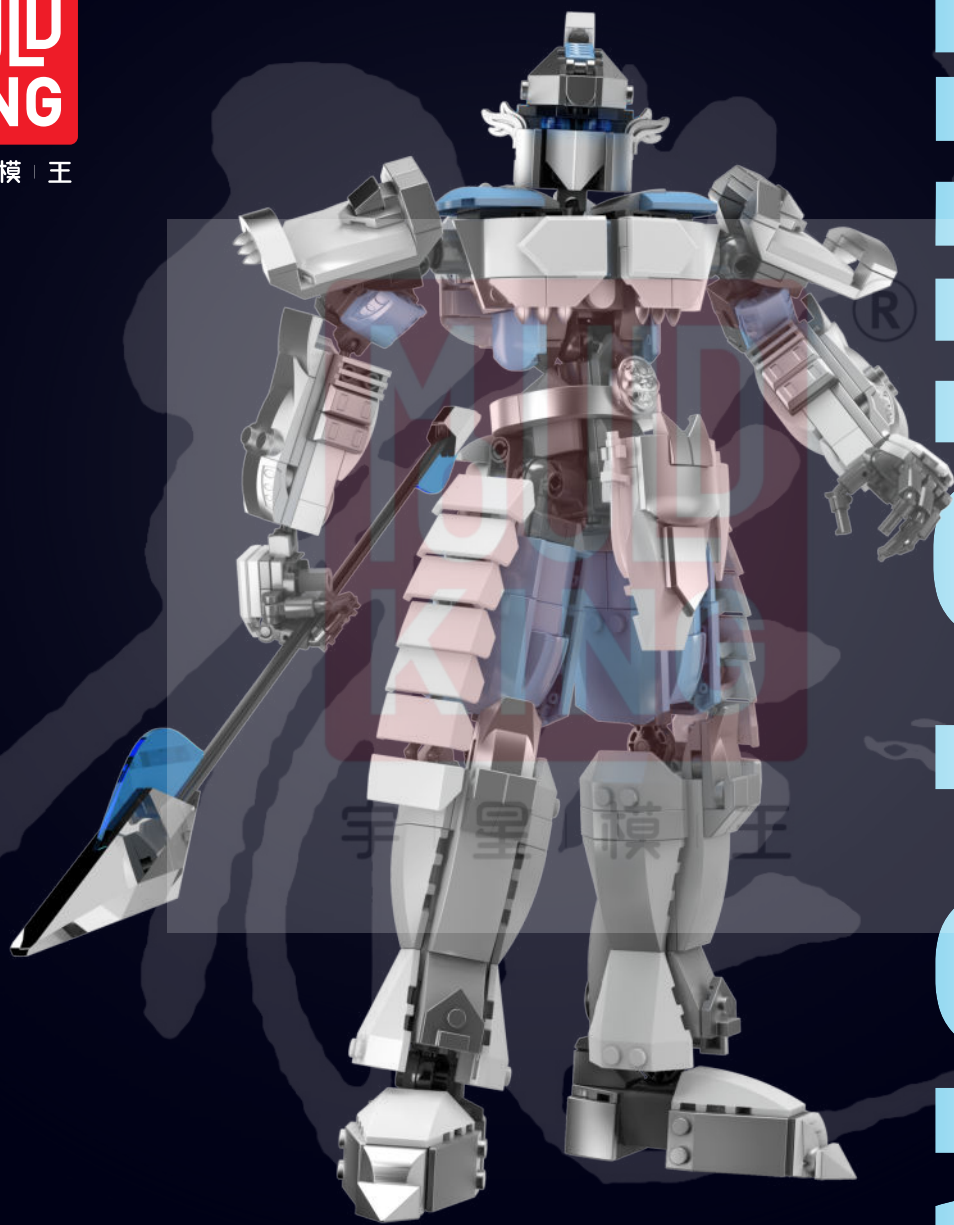

LEGO