

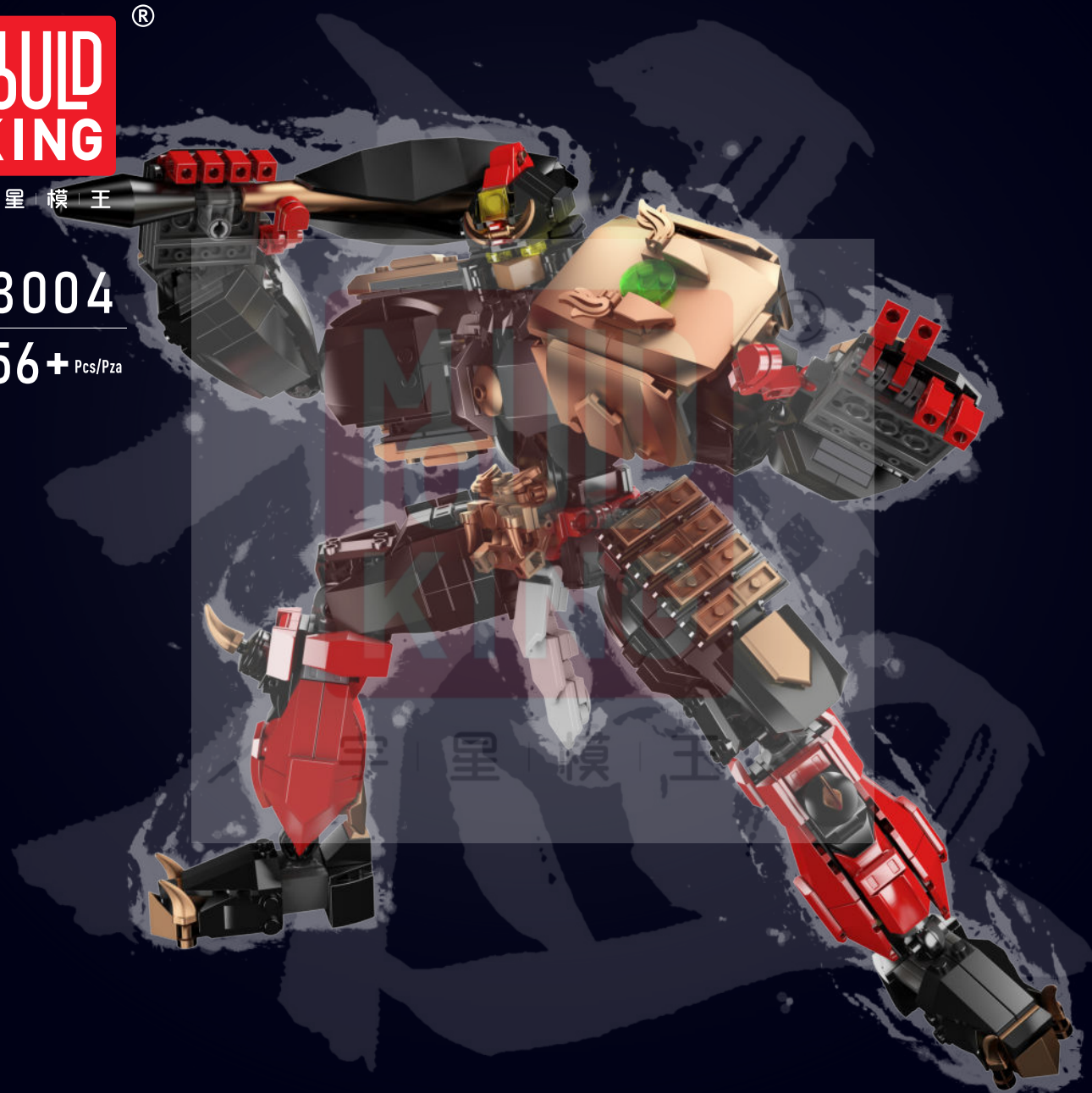

宇星模王

93004

956+ Pcs/Pza



OPEN

Customer Service

客户服务



www.yx-mk.com



MOULD KING

广东宇星科技

微信扫描二维码，关注公众号。
获取第一手的新品资讯，享受便捷的补件服务。

酷砖家
BriXpert

酷砖家系列是宇星设立的全新子品牌/系列，本系列所有套装均由国内外顶级设计师操刀设计或授权，旨在为消费者带来高水准的积木设计套装和与众不同的拼搭体验。

BriXpert series is a new sub-brand/series set up by Mould King. Models of this series are all designed or authorized by top designers/MOCers around the world, aiming at bringing consumers with high-level brick sets and a unique building experience.





五虎上将，出自于《三国演义》，是指汉末三国时期，跟随刘备建立蜀汉政权的五位将军，分别为关羽、张飞、赵云、马超、黄忠。陈寿最早作《三国志》时，将五人并列合为一传，但还并未提出五虎上将的概念，而后经过漫长的历史演变，这五人被塑造成五虎将，并在文学作品、历史书籍、个人作品集都有不同程度的记录，在民间更是以艺术的形式被广为流传。随着时代的发展，五人的顺序也出现各种版本的改变。清乾隆皇帝主持修订的《四库全书》也有将五虎将收录。

Five Tiger Generals, from "The Romance of the Three Kingdoms", refers to the five generals who followed Liu Bei to establish the Shuhan regime during the Three Kingdoms period at the end of Han Dynasty in Chinese history, namely Guan Yu, Zhang Fei, Zhao Yun, Ma Chao, and Huang Zhong. When Chen Shou first wrote "Three Kingdoms", he put five people side by side into one biography, but he didn't put forward the concept of five generals. After a long historical evolution, these five people were shaped into the Five Tigers, and they were recorded to varying degrees in literary works, history books, and personal collections, and they were widely circulated among the people in the form of art. With the development of the times, the order of the characters of the five people has also changed in various versions. The "Siku Quanshu" presided over by Emperor Qianlong of the Qing Dynasty also included the Five Tiger Generals.



张飞，字益德（也作“翼德”），涿郡（今河北保定涿州市）人，三国时期蜀汉名将。张飞勇武过人，与关羽并称为“万人敌”。公元 184 年黄巾起义爆发，刘备在涿县组织起了一支义勇军参与扑灭黄巾军的战争，张飞与关羽一起加入，随刘备辗转各地。三人情同兄弟，寝则同床，刘备出席各种宴会时，他和关羽终日侍立在刘备身旁。公元 196 年因交恶曹豹而被吕布所破。吕布败亡之后，张飞被任命为中郎将。公元 200 年刘备衣带诏事情泄露，率领关羽、张飞逃走，杀徐州刺史车胄。后刘备战败，关羽被擒，刘备与张飞投奔袁绍。公元 208 年刘备于长坂坡败退时，张飞仅率二十骑断后，据当阳桥厉声大喝，曹军无人敢逼近，刘备因此得以免难。刘备入蜀后，张飞与诸葛亮、赵云进军西川，分定郡县。在抵达江州时义释了刘璋手下的巴郡太守严颜。在巴西之战中，击败魏国名将张郃。在武都之战中，兵败而还。刘备称帝后，张飞晋升为车骑将军、领司隶校尉，封西乡侯。同年，张飞因为暴而无恩，被部将范强、张达杀害。谥曰桓侯。

Zhang Fei, courtesy name Yide, was born in Zhuojun (now Zhuozhou City, Baoding, Hebei, China), and was a famous general of the Shu Han Dynasty during the Three Kingdoms period in Chinese history. Zhang Fei is so brave that he and Guan Yu are called "the enemy of ten thousand people". When the Yellow Turban Uprising broke out in 184 AD, Liu Bei organized a volunteer army in Zhuoxian County to participate in the war to exterminate the Yellow Turban Army. Zhang Fei and Guan Yu joined together and followed Liu Bei to various places. The three love each other as brothers, and they share the same bed when they sleep. When Liu Bei attends various banquets, he and Guan Yu stand by Liu Bei's side all day long. In 196 AD there was a war with Lu Bu due to a conflict with Cao Bao. After Lu Bu's defeat, Zhang Fei was appointed General of Zhonglang. In 200 A.D., Liu Bei's edict was leaked, led Guan Yu and Zhang Fei to escape, and killed Che Zhou, the governor of Xuzhou. After Liu Bei was defeated, Guan Yu was captured by the enemy, and Liu Bei and Zhang Fei went to Yuan Shao. When Liu Bei was defeated at Changbanpo in 208 A.D., Zhang Fei only led 20 cavalry to help Liu Bei retreat. He yelled at Dangyang Bridge, and no one in Cao's army dared to approach, so Liu Bei was spared. After Liu Bei entered Shu, Zhang Fei, Zhuge Liang and Zhao Yun marched into Xichuan. When he arrived in Jiangzhou, he released Liu Zhang's Bajun prefect Yan Yan because of his loyalty. In the Battle of Brazil, he defeated Zhang Yun, a famous Wei general. In the battle of Wudu, he was defeated and returned. After Liu Bei proclaimed himself emperor, Zhang Fei was promoted to General of Chariots and Cavalry, Captain of Sili Xiaowei, and granted the title of Marquis of Xixiang. In the same year, Zhang Fei was killed by the generals Fan Qiang and Zhang Da because of his violence and mercilessness. His posthumous title is Marquis Huan.



据水断桥

建安十三年(208年),丞相曹操南征刘表,会刘表病死,少子刘琮投降曹操。刘备自樊城经襄阳南下江陵,诸葛亮劝刘备袭取襄阳,被刘备拒绝。曹操抵达襄阳,听说刘备已经南下,立即派出曹纯率领五千精骑追击,一日一夜追出三百余里,在当阳长坂坡追上刘备,刘备和诸葛亮、张飞、赵云等数十骑逃亡。张飞奉命率二十骑断后,赵云则保护甘夫人和阿斗慢行。张飞依仗地势,据水断桥,瞋目横矛,咆哮道:“身是张益德也,可来共决死!(我就是张益德,放马过来决一死战!)”,吼声震天。因张飞素有勇名,敌军内无人敢于向前,刘备等人得以顺利撤退至汉津,与关羽船队会合,然后抵达夏口,会合刘表长子江夏太守刘琦。赤壁之战中,刘备、关羽、张飞的战斗力给讨虏将军帐下左部督周瑜留下了深刻印象,他在之后给孙权的上书中称“刘备以枭雄之姿,而有关羽、张飞熊虎之将”。

Zhang Fei broke the bridge according to the water. In the thirteenth year of Jian'an (208), Prime Minister Cao Cao marched south to Liu Biao, and Liu Biao died of illness. The youngest son Liu Cong surrendered to Cao Cao. Liu Bei went south from Fancheng to Jiangling via Xiangyang. Zhuge Liang persuaded Liu Bei to attack Xiangyang, but Liu Bei refused. When Cao Cao arrived in Xiangyang, he heard that Liu Bei had gone south, so he immediately sent Cao Chun to lead five thousand cavalry in pursuit. They chased for more than three hundred miles in a day and a night, and caught up with Liu Bei in Changbanpo, Dangyang. Liu Bei, Zhuge Liang, Zhang Fei, Zhao Yun and other dozens of horses fled. After Zhang Fei was ordered to lead 20 riders, Zhao Yun protected Mrs. Gan and Adou to drive slowly. Relying on the terrain and breaking the bridge by the water, Zhang Fei roared, "I am Zhang Yide, let the horse come over and fight to the death!", his roar shaking the sky. Because of Zhang Fei's reputation for bravery, no one in the enemy army dared to move forward. Liu Bei and others were able to retreat to Hanjin and join Guan Yu's fleet. During the Battle of Chibi, the fighting power of Liu Bei, Guan Yu, and Zhang Fei left a deep impression on Zhou Yu, the left governor of the general's account. In his letter to his master Sun Quan, he stated that "Liu Bei is a hero, while Guan Yu and Zhang Fei are generals of bears and tigers."

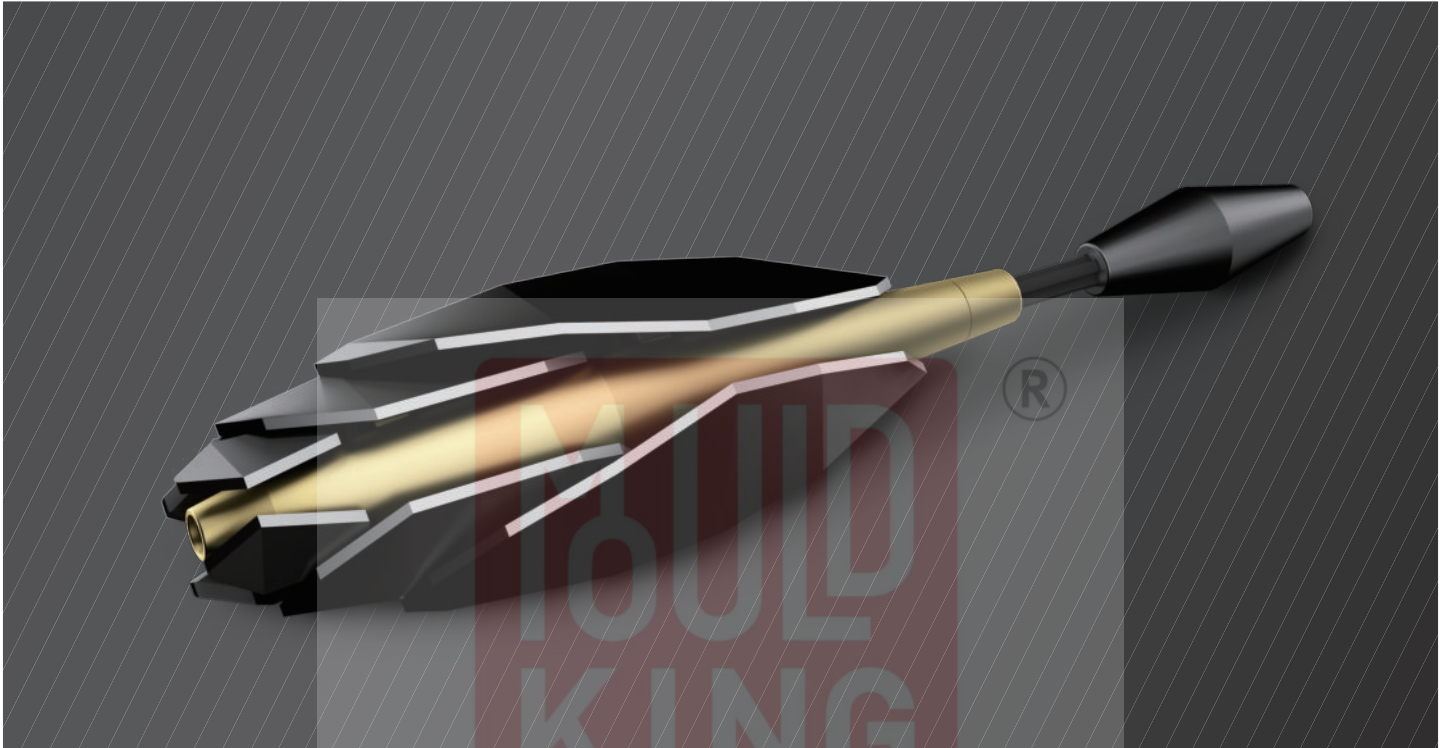

蛇鳞锤

宇 | 皇 | 模 | 王

“强者的武器，强而有力！”

以丈八蛇矛为蓝本配合张飞身型全新设计的蛇鳞状战锤，鳞片可伸缩，外形简洁大气，完美衬托张飞的勇者之风。

"The weapon of the strong, strong and powerful!"

Based on the Zhangba Snake Spear as the model and combined with Zhang Fei's tall stature, it is a newly designed snake-scale warhammer. Its scales are stretchable, and its shape is simple and elegant, which perfectly complements Zhang Fei's brave spirit.

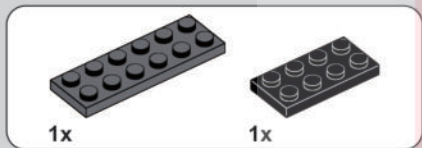
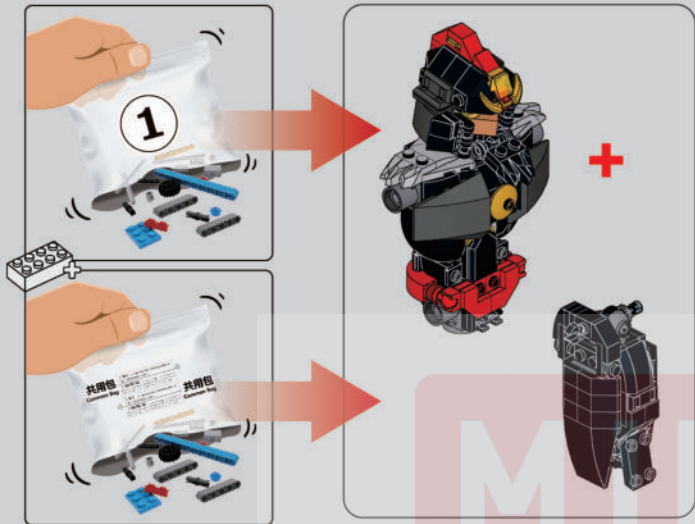

1

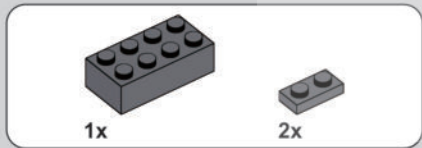
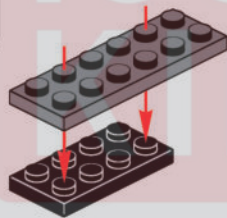

2

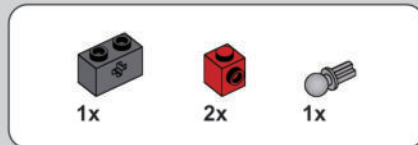
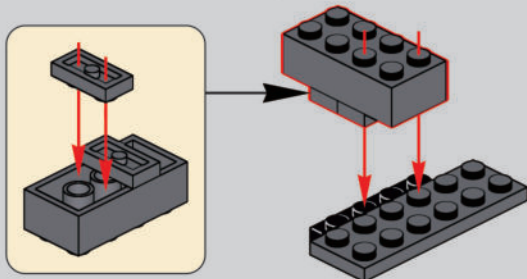

3

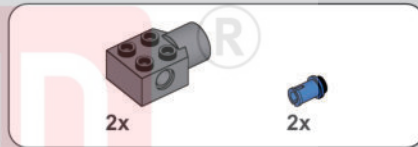
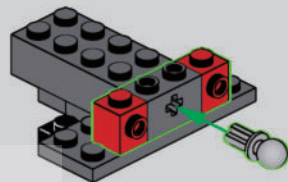

4

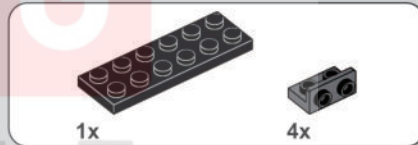
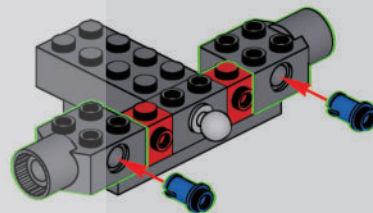

5

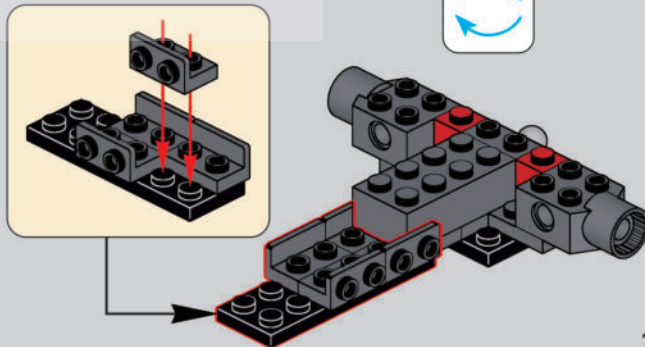

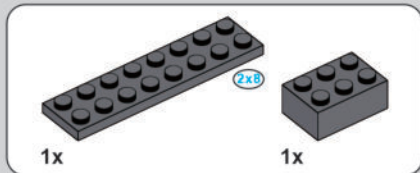

6

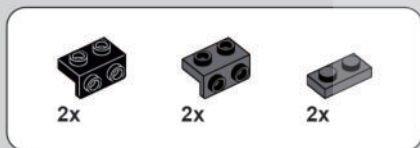
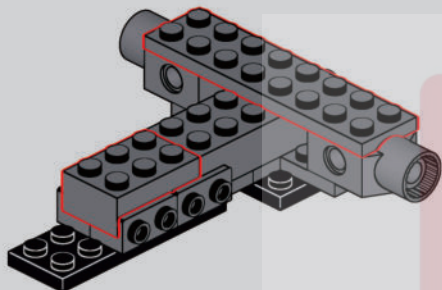

7

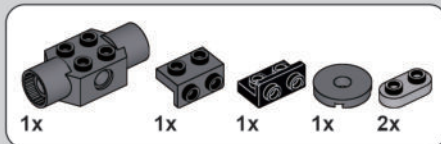
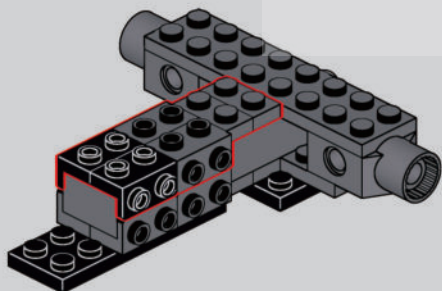

8

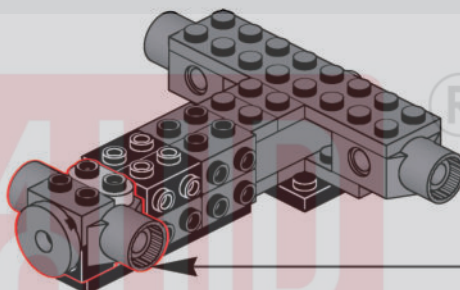

9

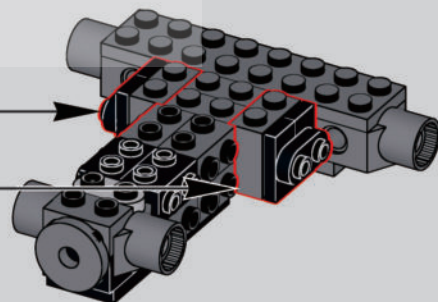
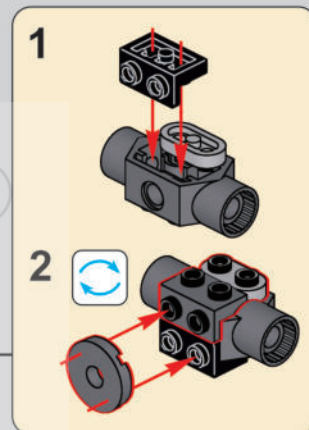
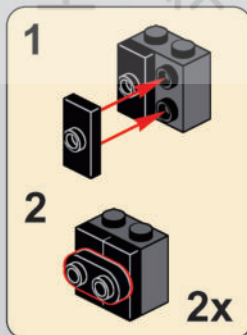

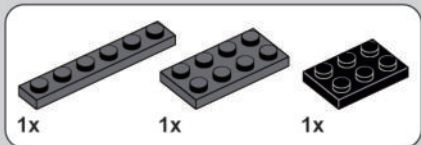

10

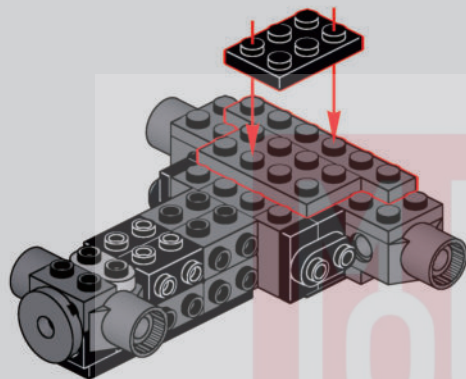

11

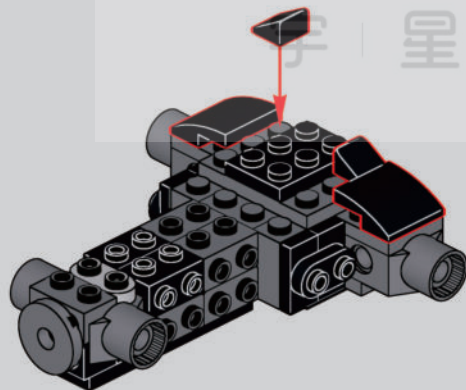

12

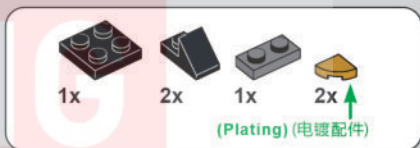
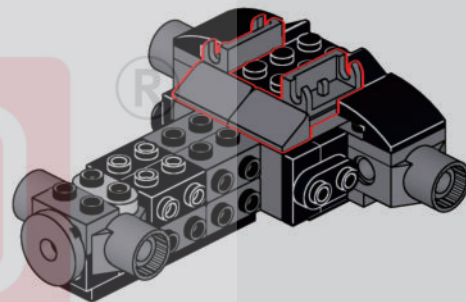

13

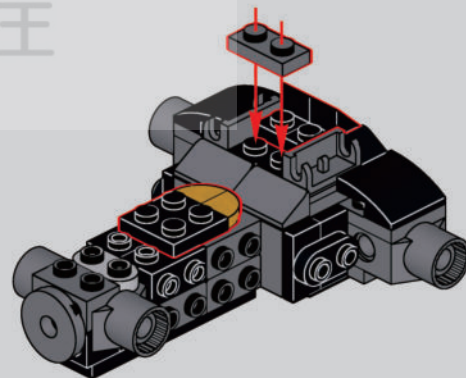

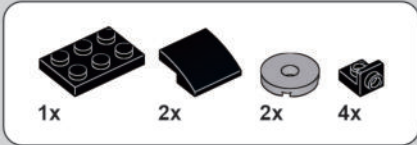

14

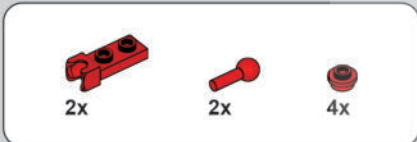
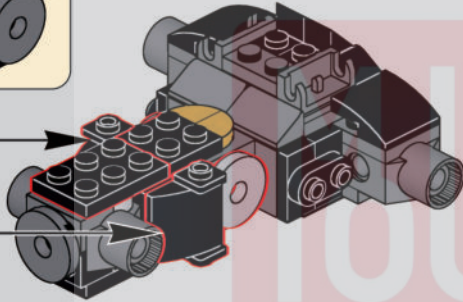
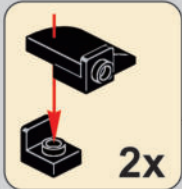
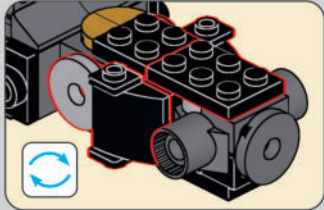

15

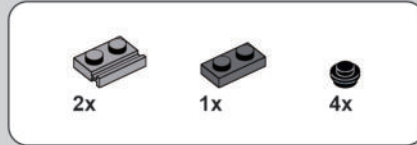
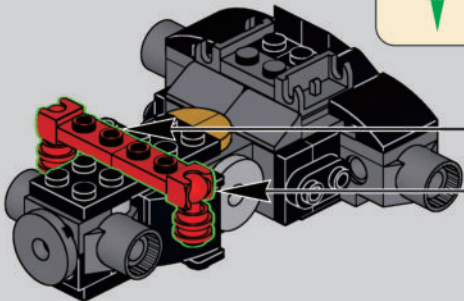
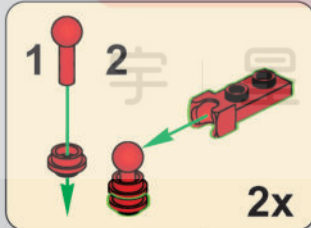

16

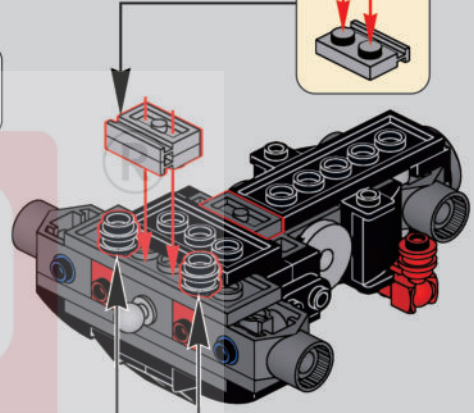
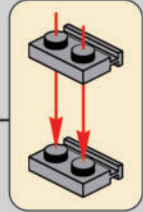

17

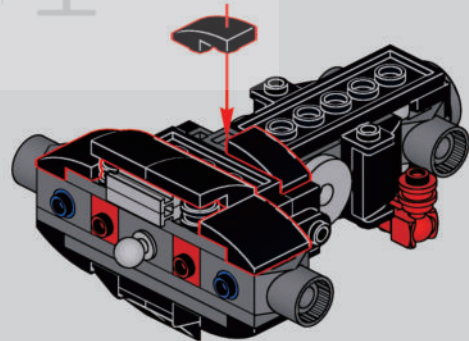



18

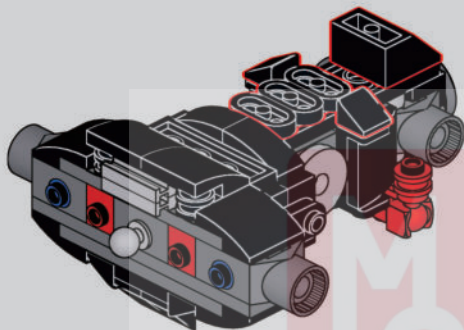

19

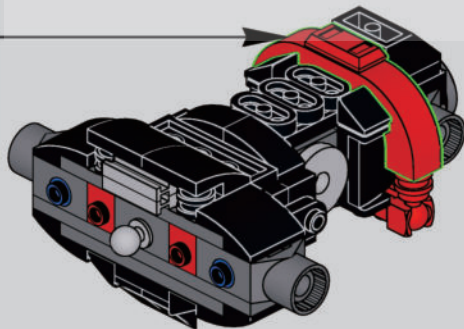
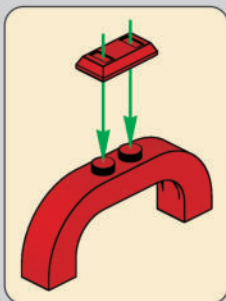

20

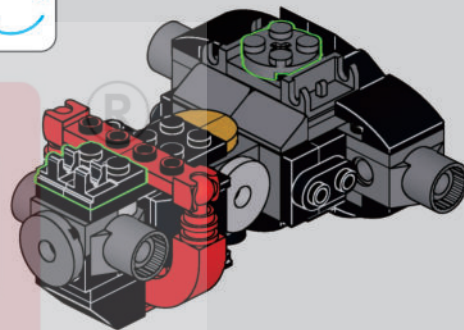

21

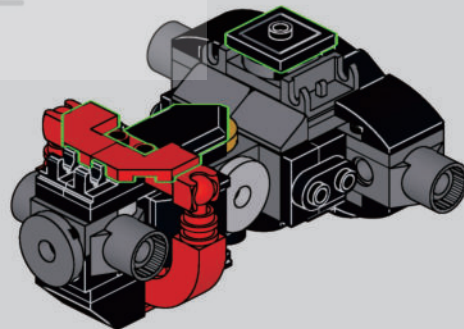

宇 | 星 | 模 | 王



22

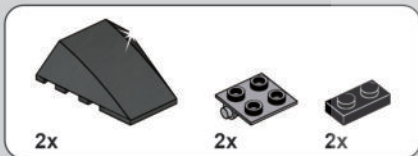
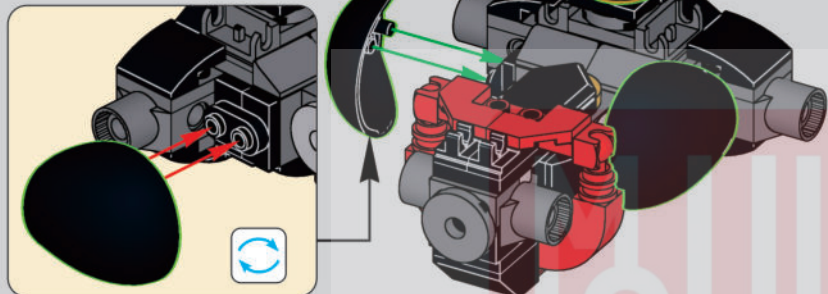

23

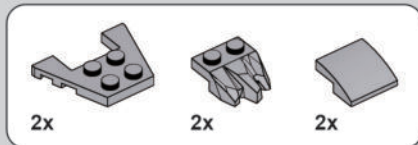
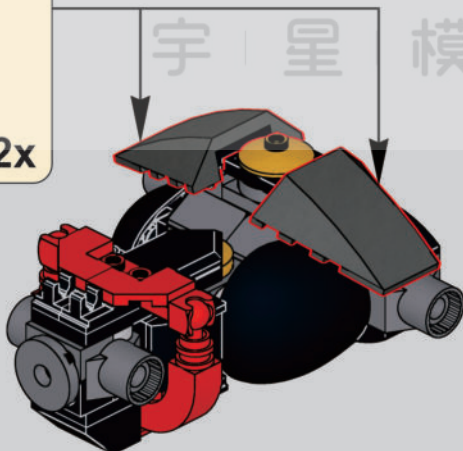
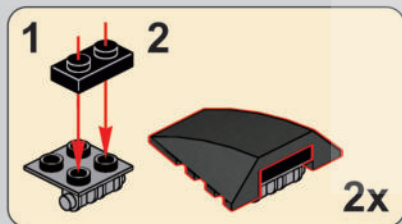

24

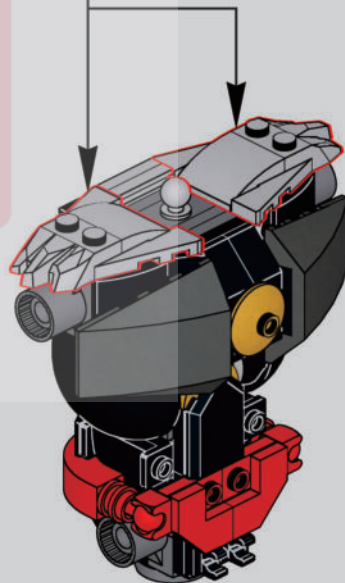
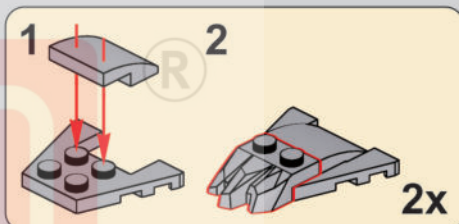



25

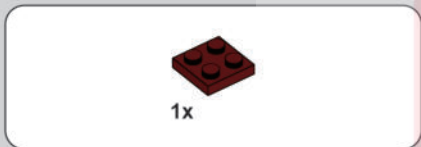
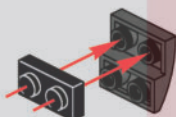

26

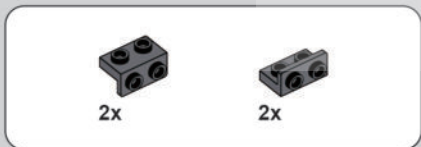

27

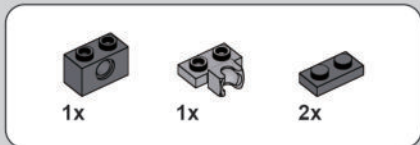
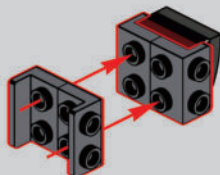

28

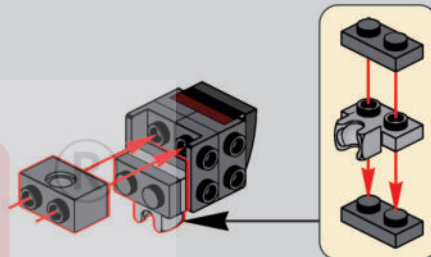

29

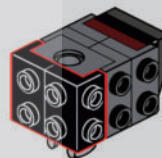

30

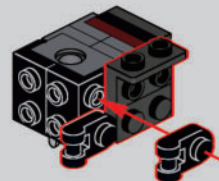



31

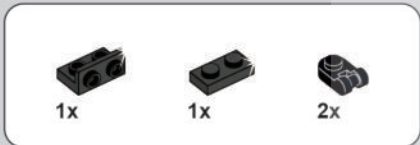
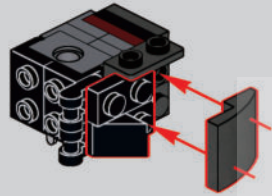

32

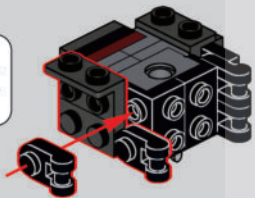

33

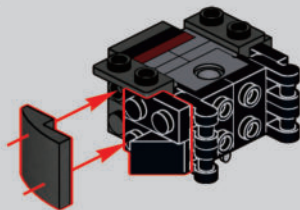

34

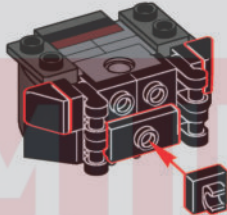

35

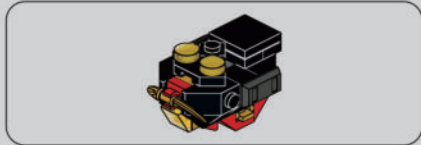
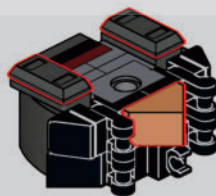

36

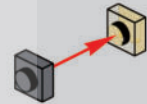

37

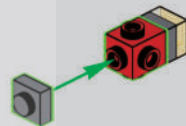

38

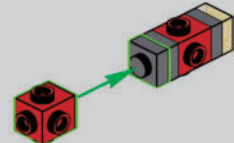

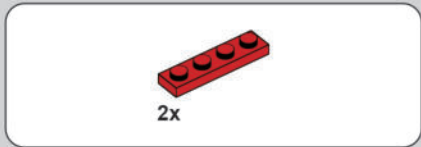

39

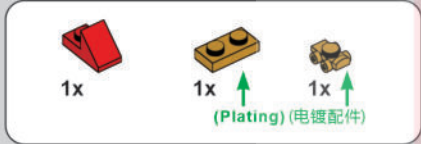
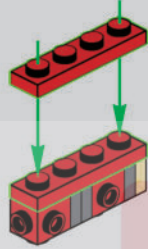

40

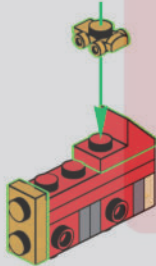

41

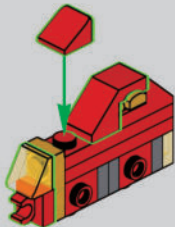

42

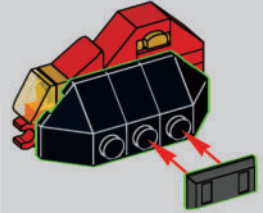

43

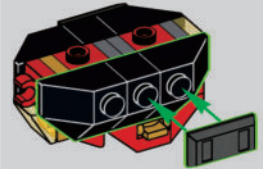

44

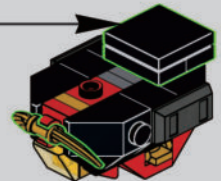
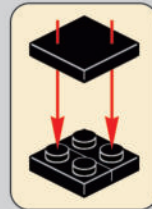



1x



1x



2x

45

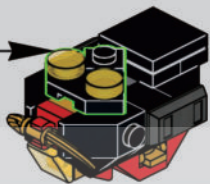
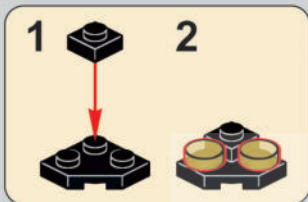

46

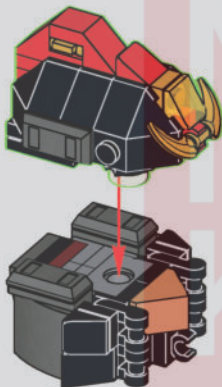

48

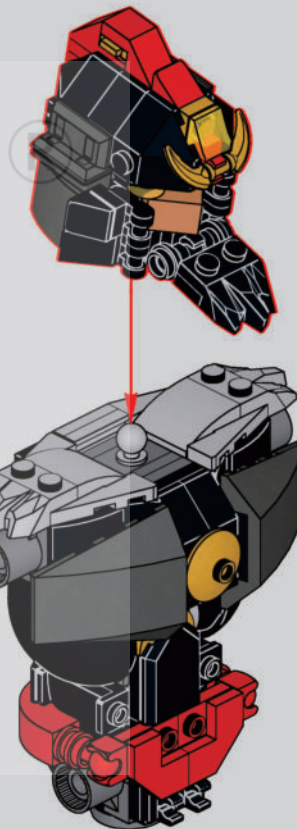

1x



1x



2x

47

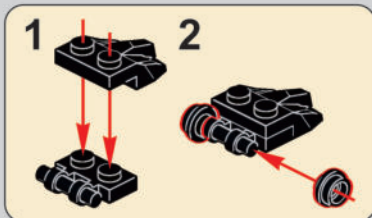

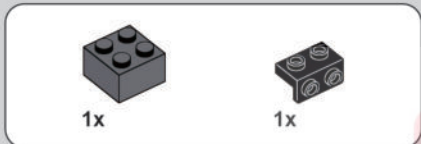
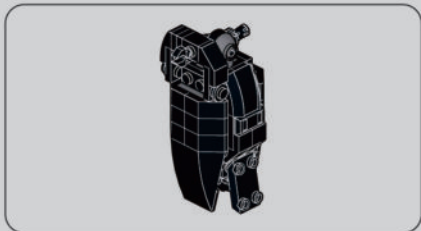

49

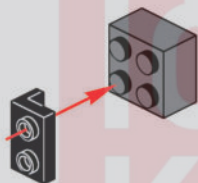

50

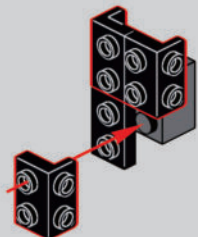

51

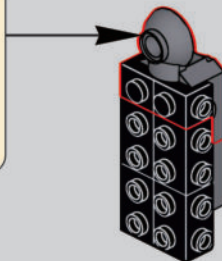
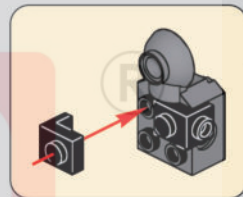

52

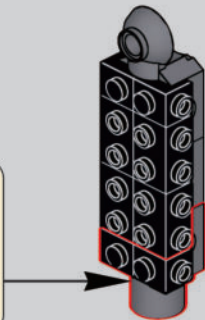
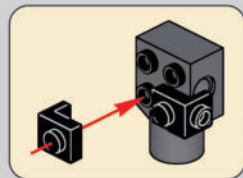



53

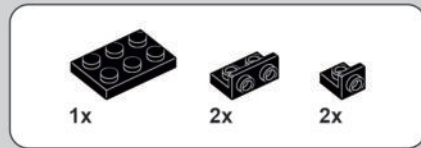
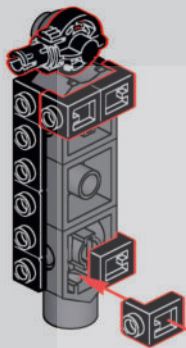

55

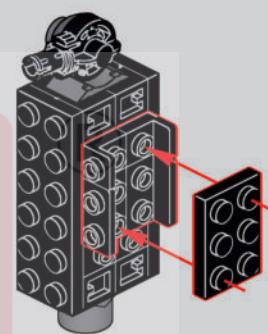

54

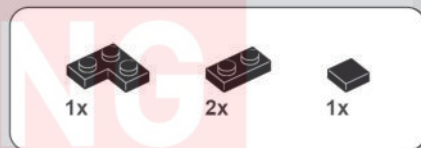
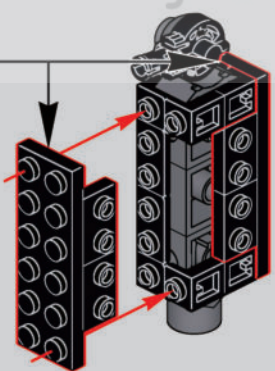
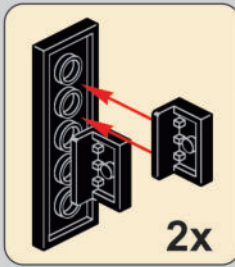

56

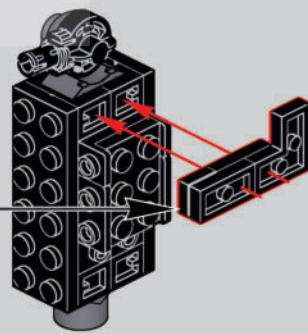
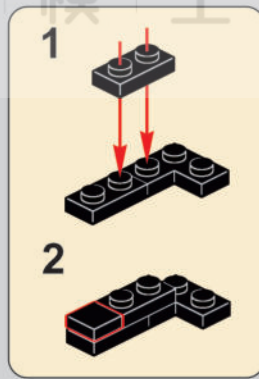

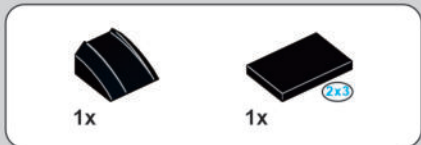

57

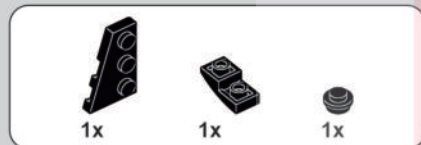
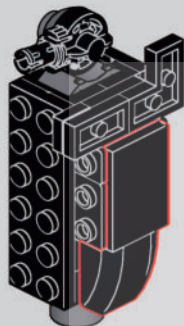

58

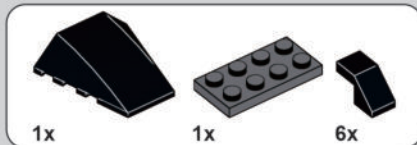
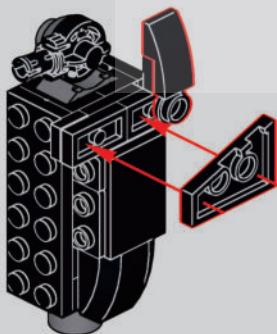

59

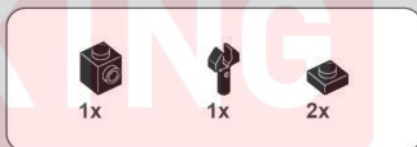
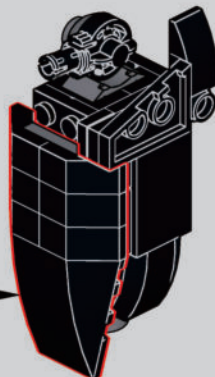
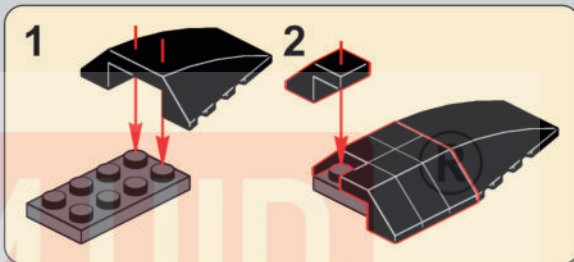

60

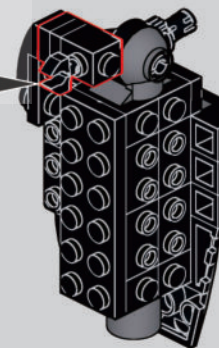
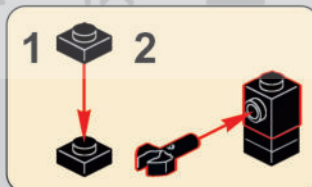



61

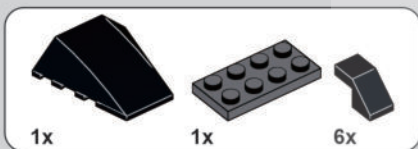
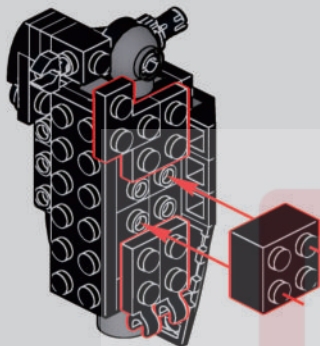

62

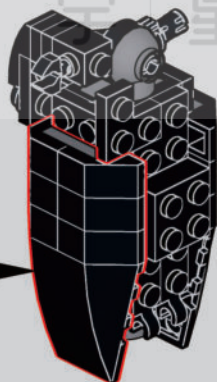
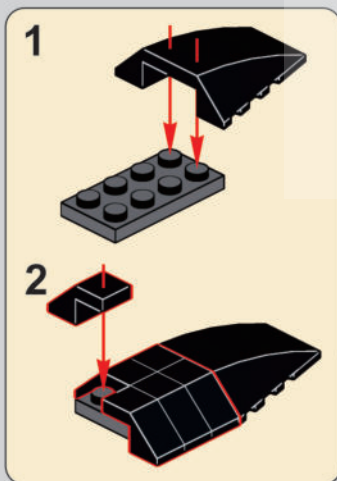

63

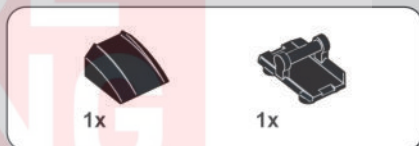
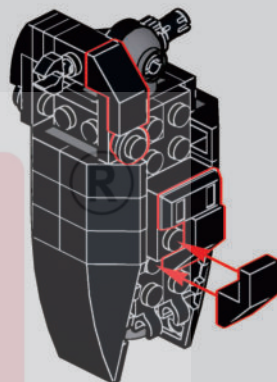

64

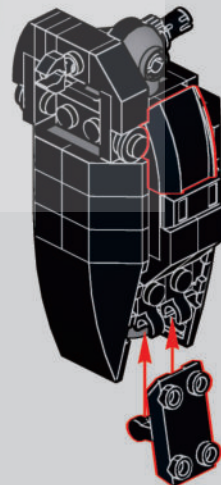

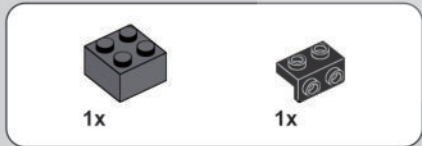
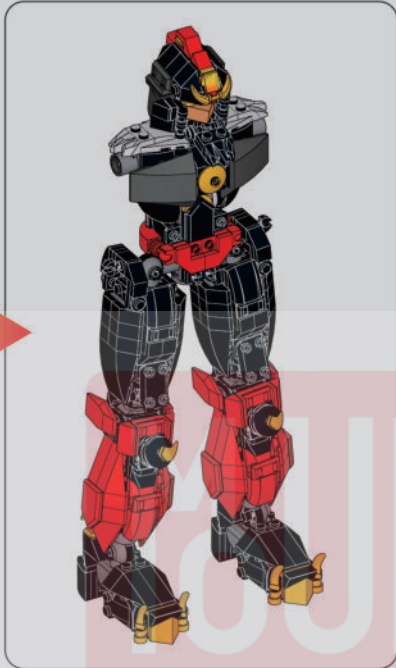

65

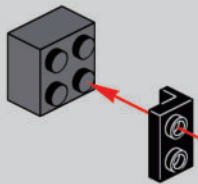

66

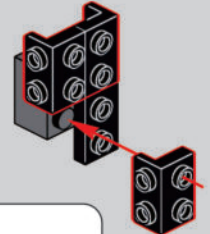

67

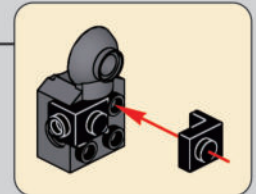
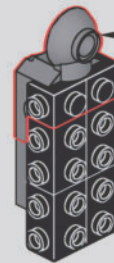

68

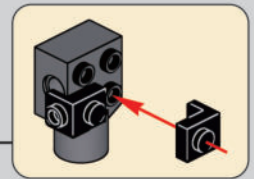



69

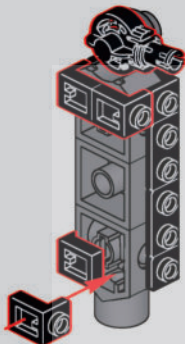

70

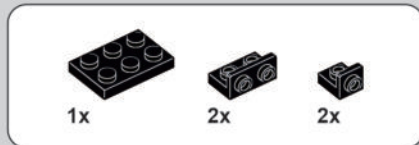
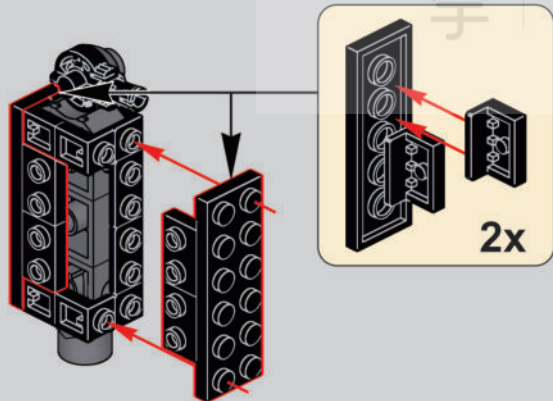

71

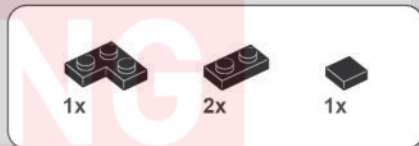
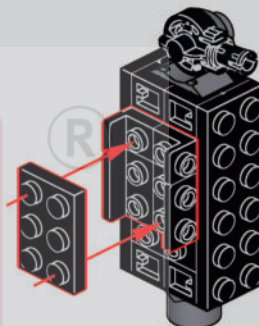

72

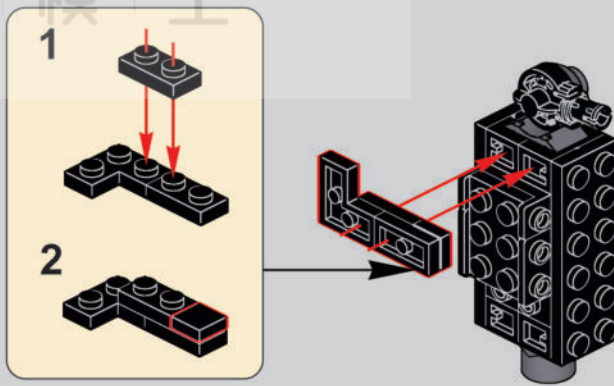

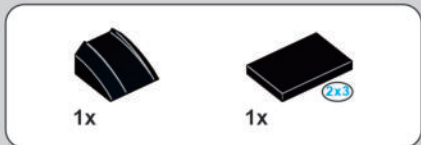

73

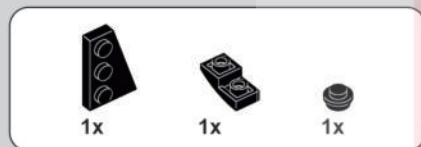
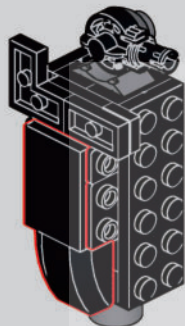

74

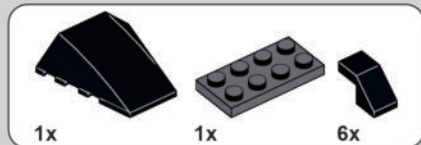
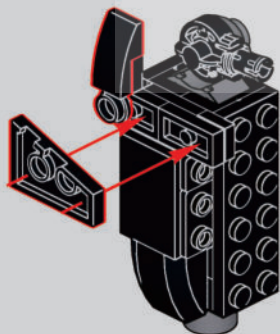

75

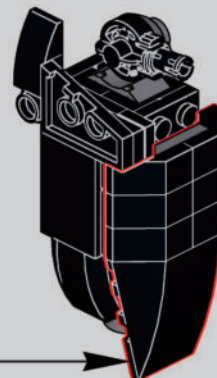
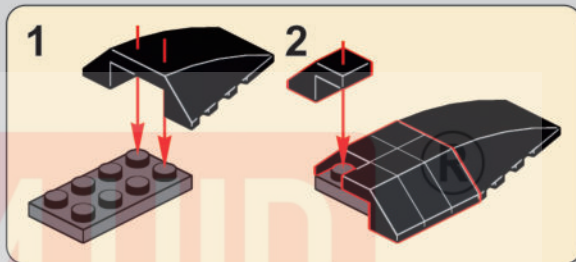

76

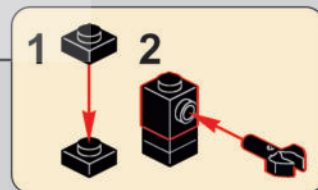
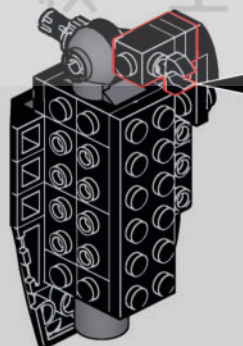



77

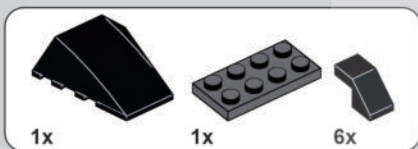
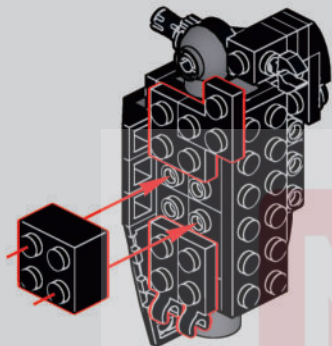

78

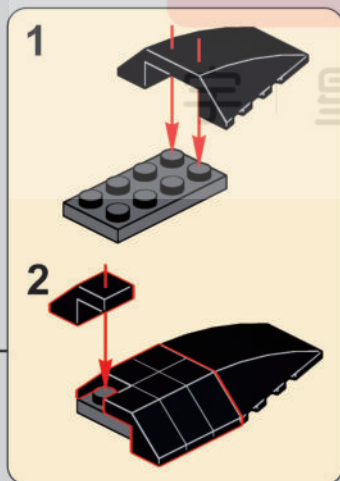
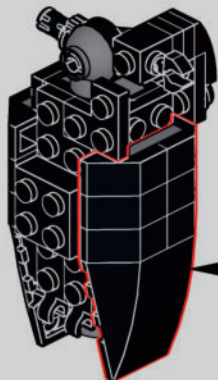

79

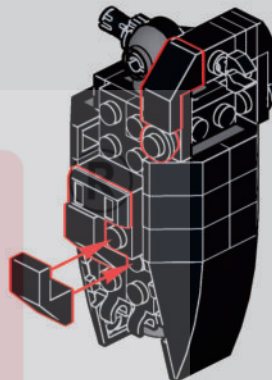

80

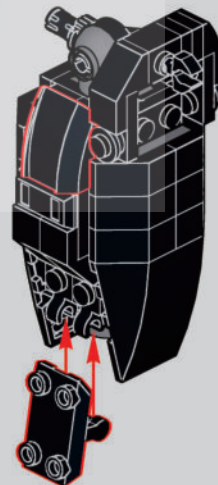

81

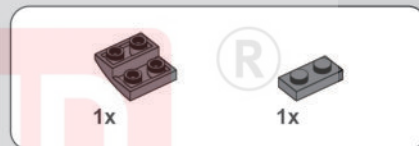
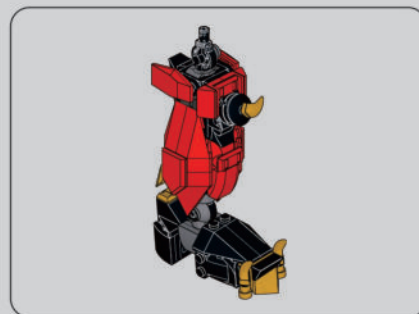
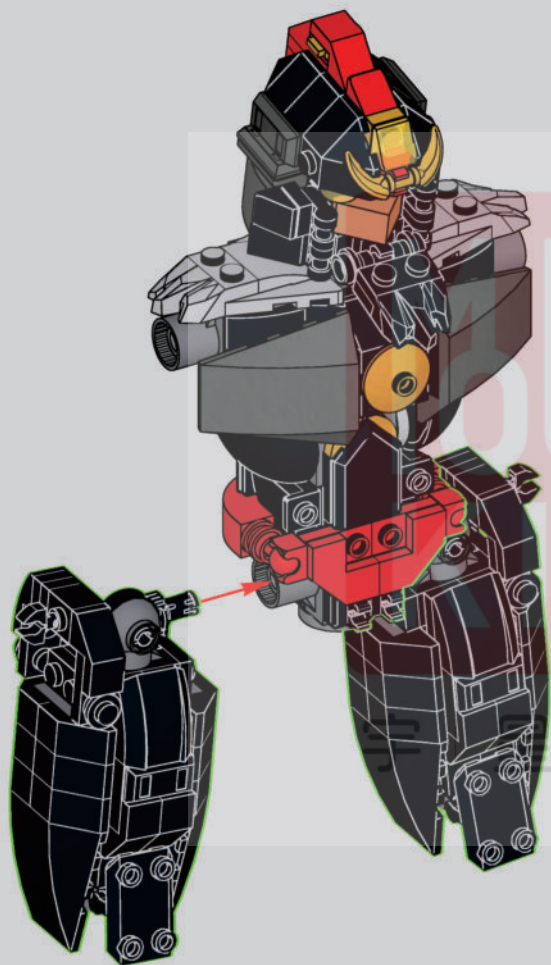

82

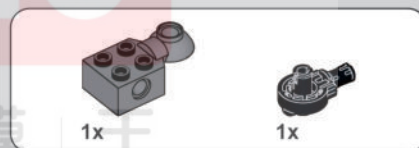
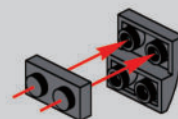

83

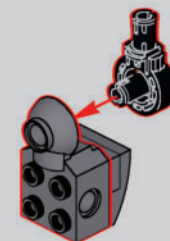

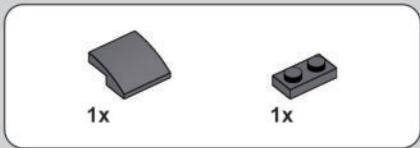

84

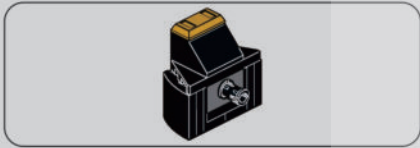
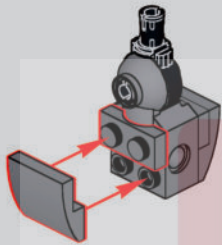

85

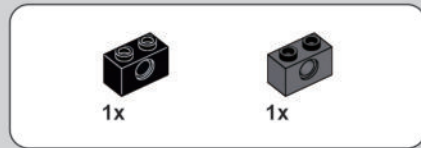
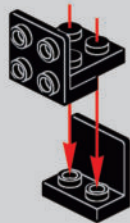

86

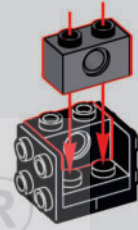

87

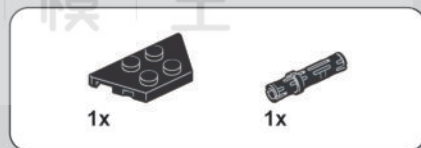
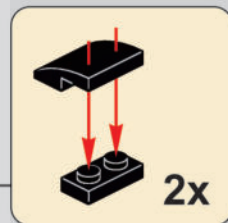
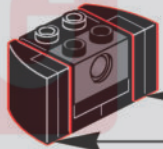

88

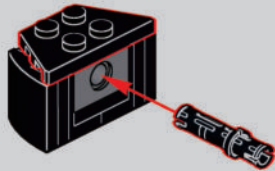



89

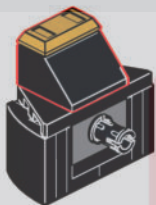

90

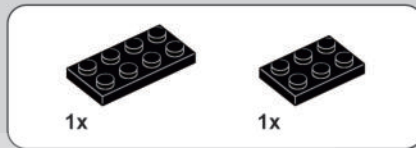
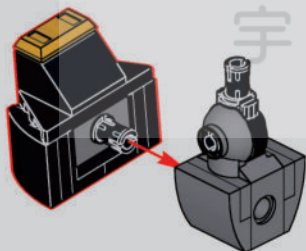

91

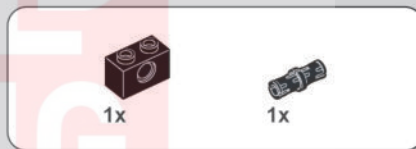
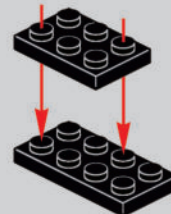

92

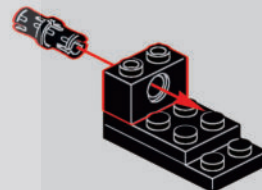

93

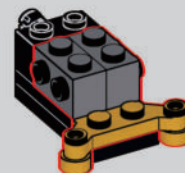



94

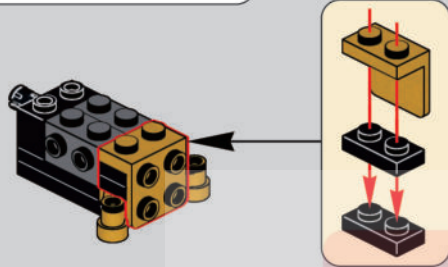

95

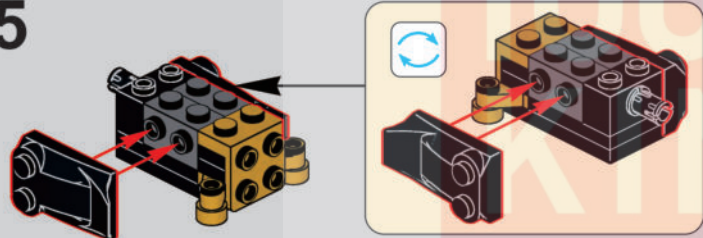

96

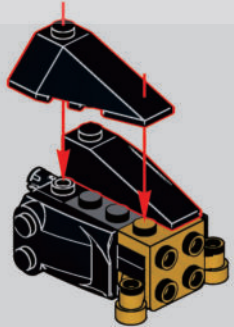

97

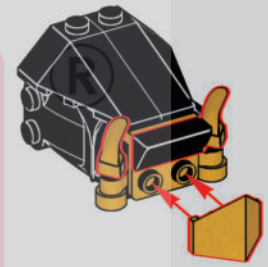

98

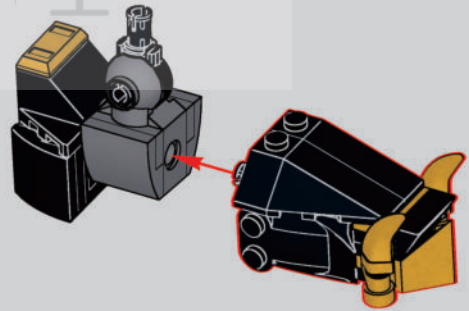

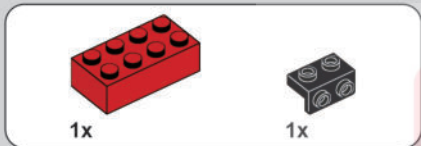
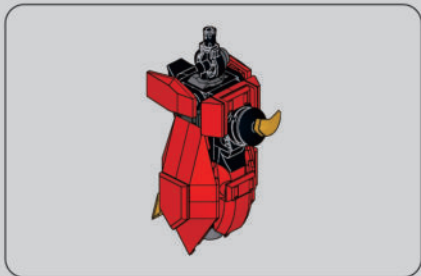

99

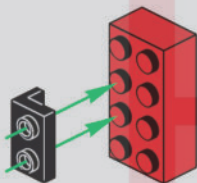

100

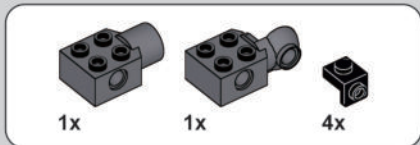
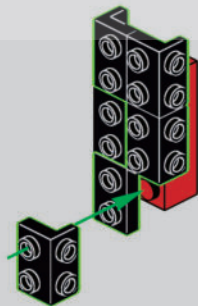

101

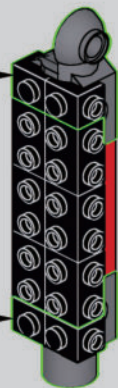
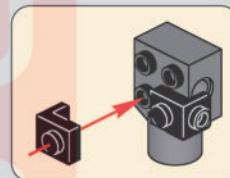
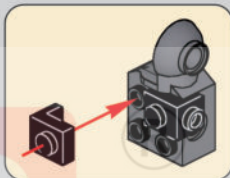

102

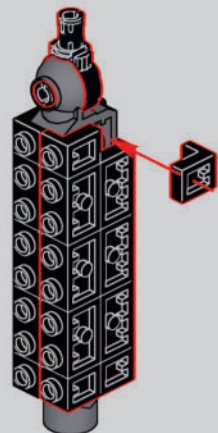



1x



1x



2x

103

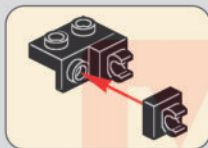
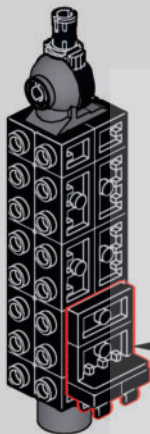

2x

104

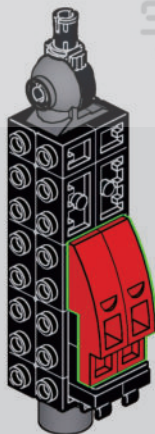

1x



1x



1x



1x

105

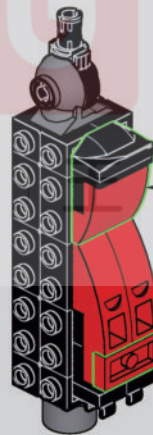
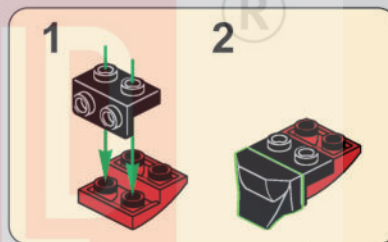

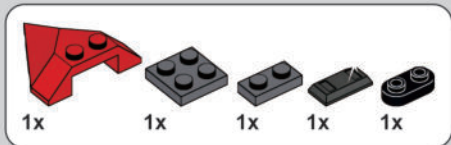

106

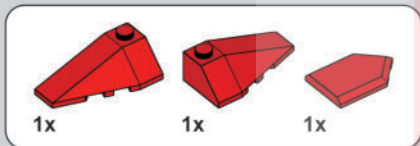
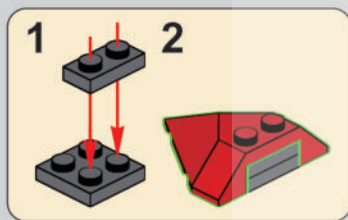

107

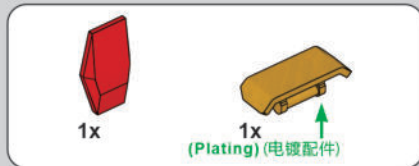
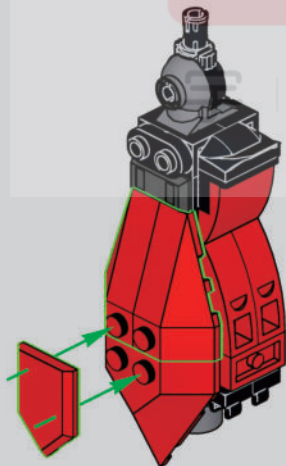

108

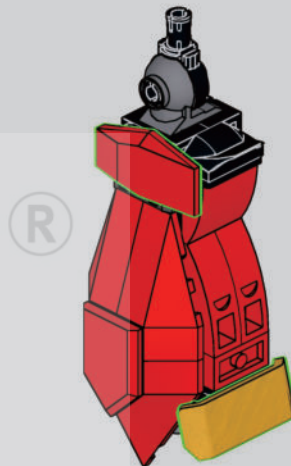

109

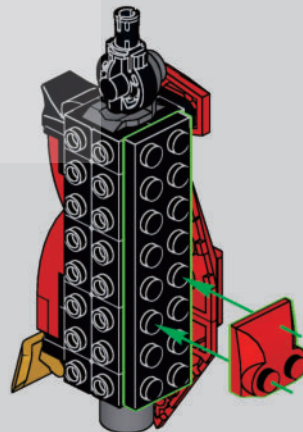



110

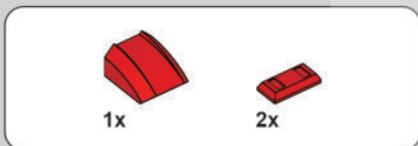
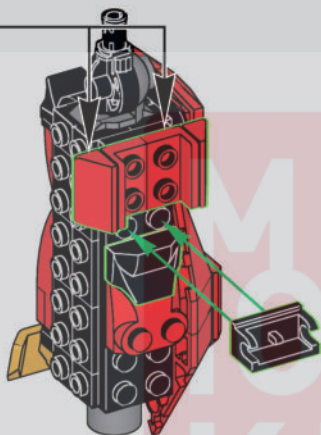
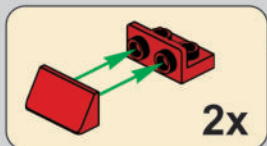

111

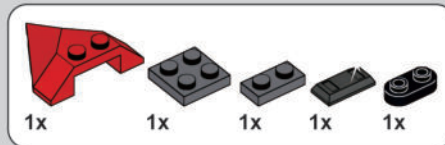
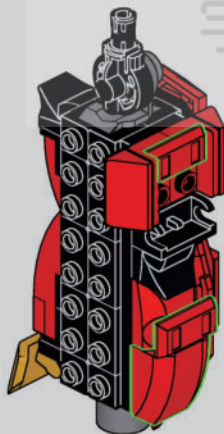

112

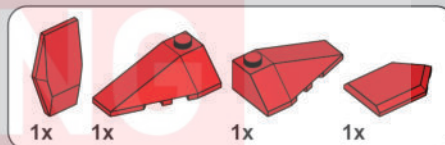
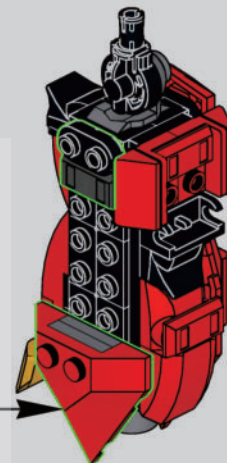
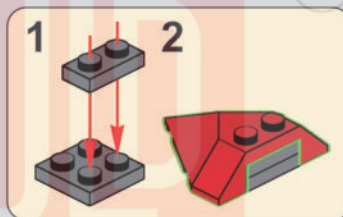

113

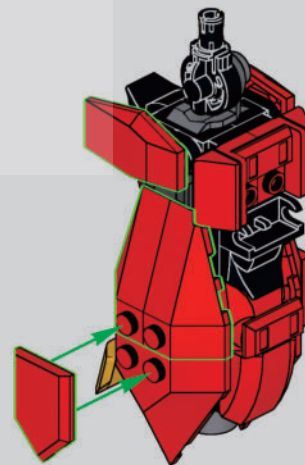



114

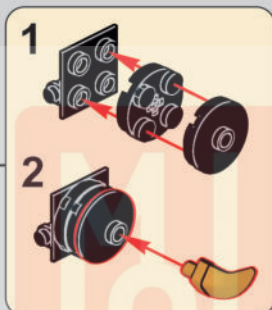
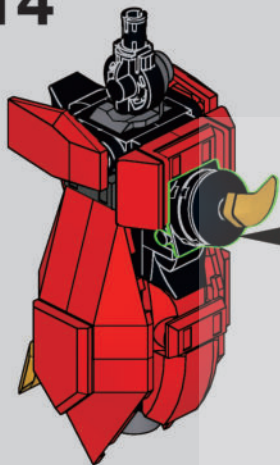

115

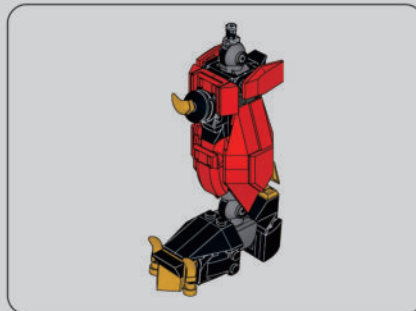

116

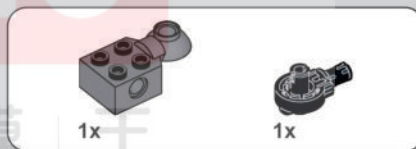
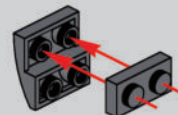

117

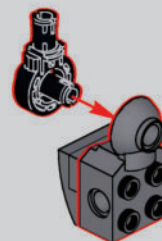

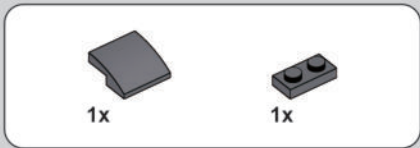

118

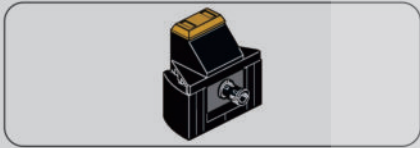
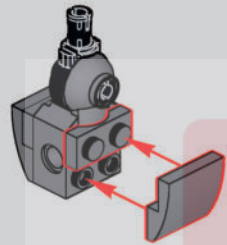

119

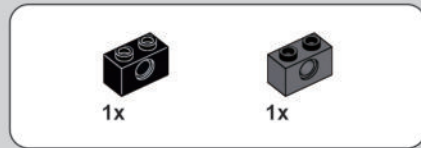
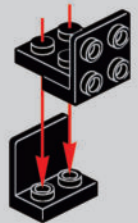

120

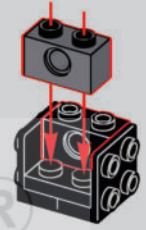

121

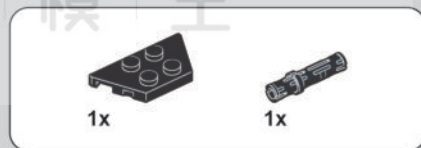
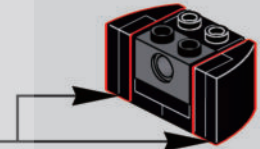
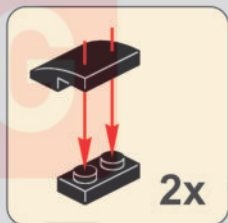

122

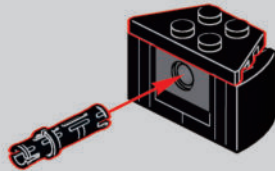



123

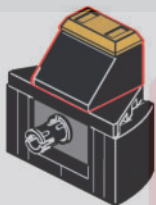

124

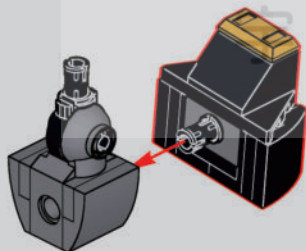

125

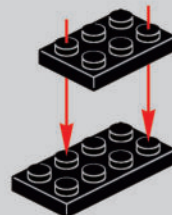

126

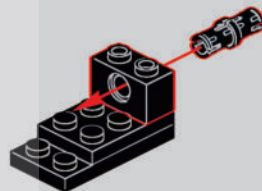

127

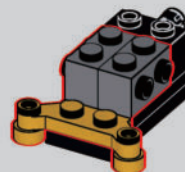



128

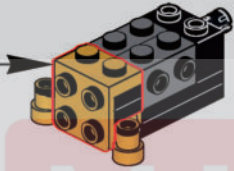
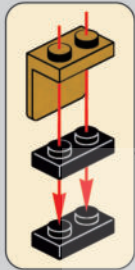

129

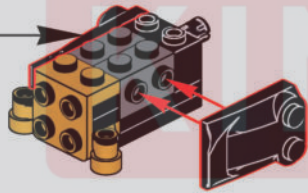
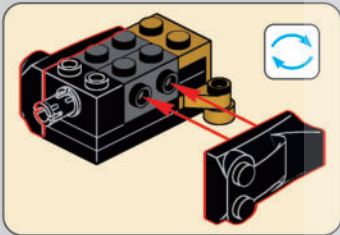

130

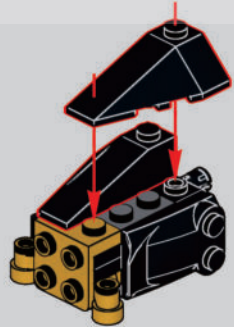

131

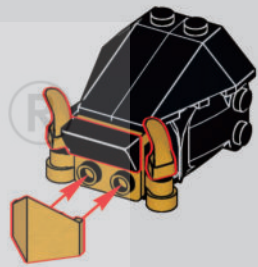

132

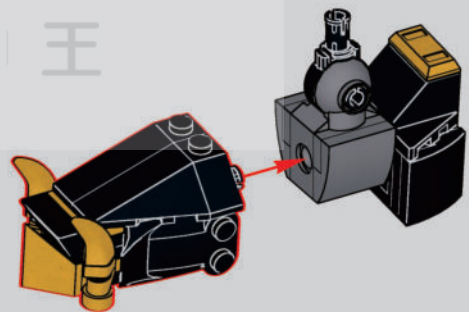

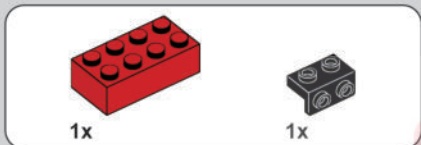
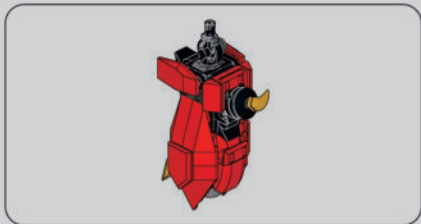

133

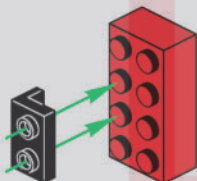

134

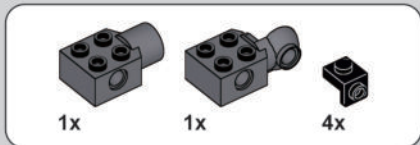
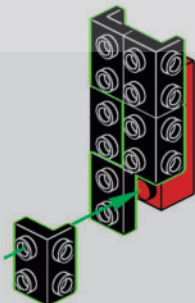

135

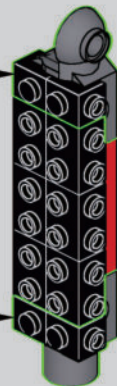
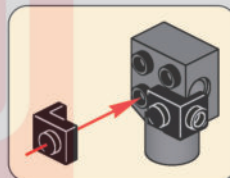
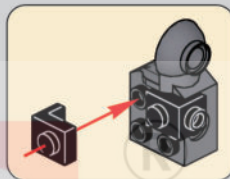

136

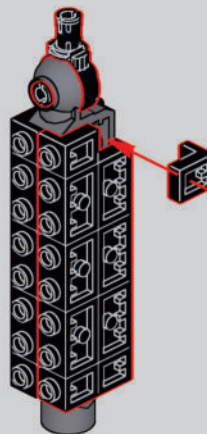



1x

1x

2x

137

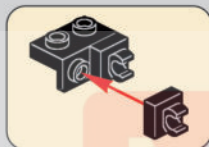
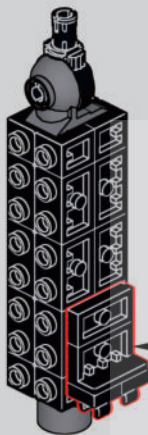

1x

1x

1x

1x

139

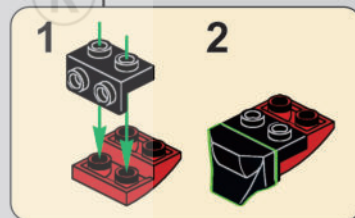

2x

138

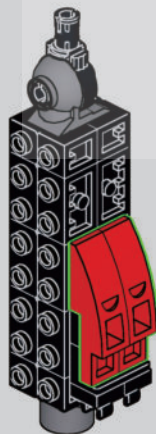

1x

1x

1x

1x

1x

140

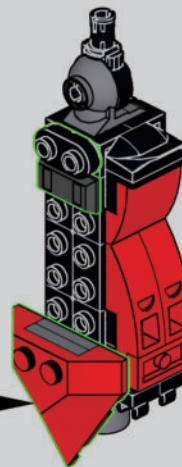
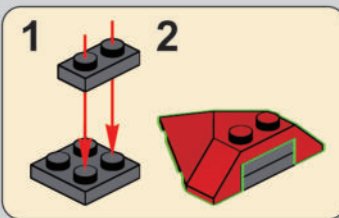

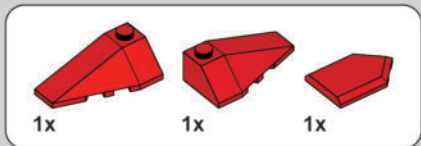

141

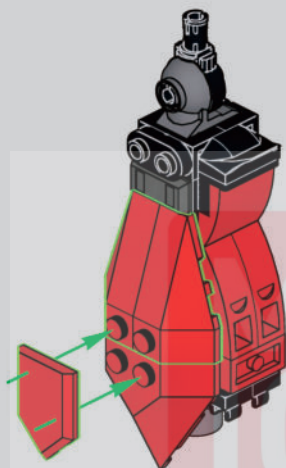

142

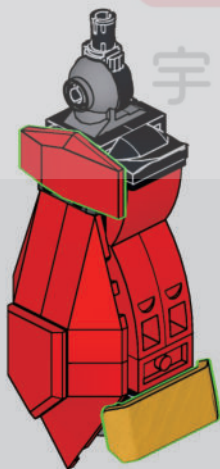

143

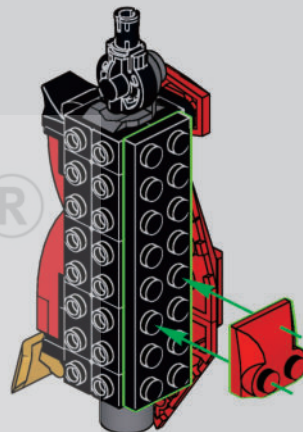

144

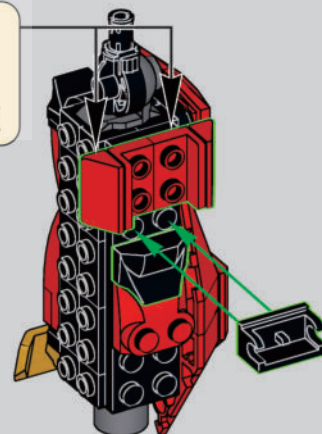
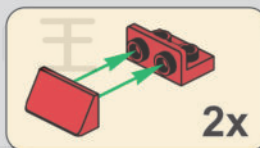

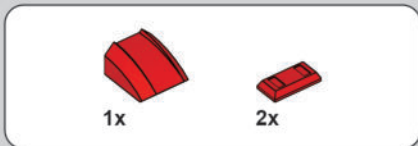

145

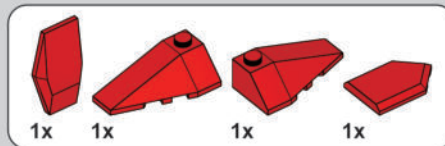
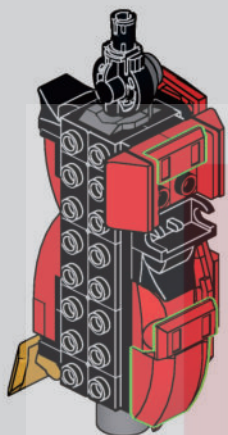

147

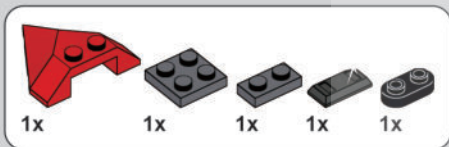
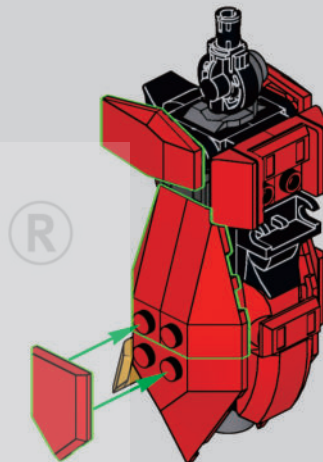

146

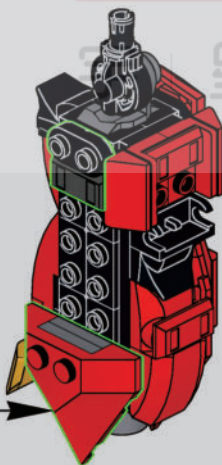
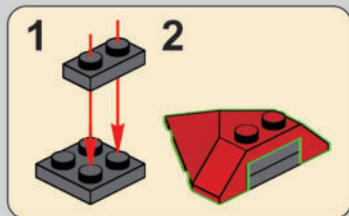

148

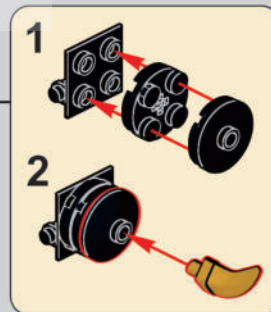
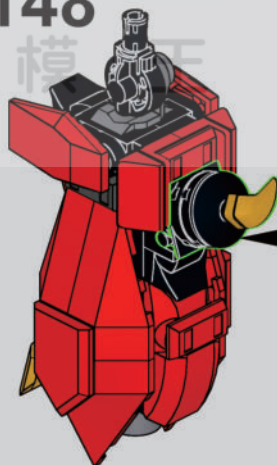

149

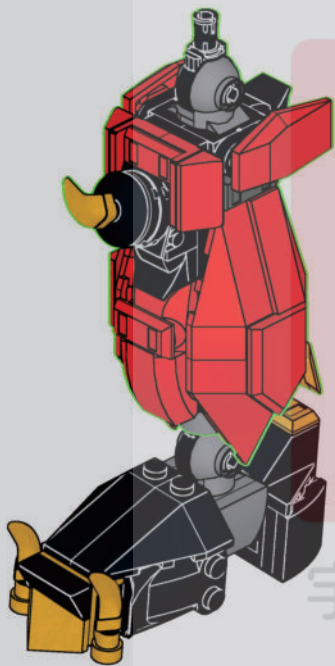

150

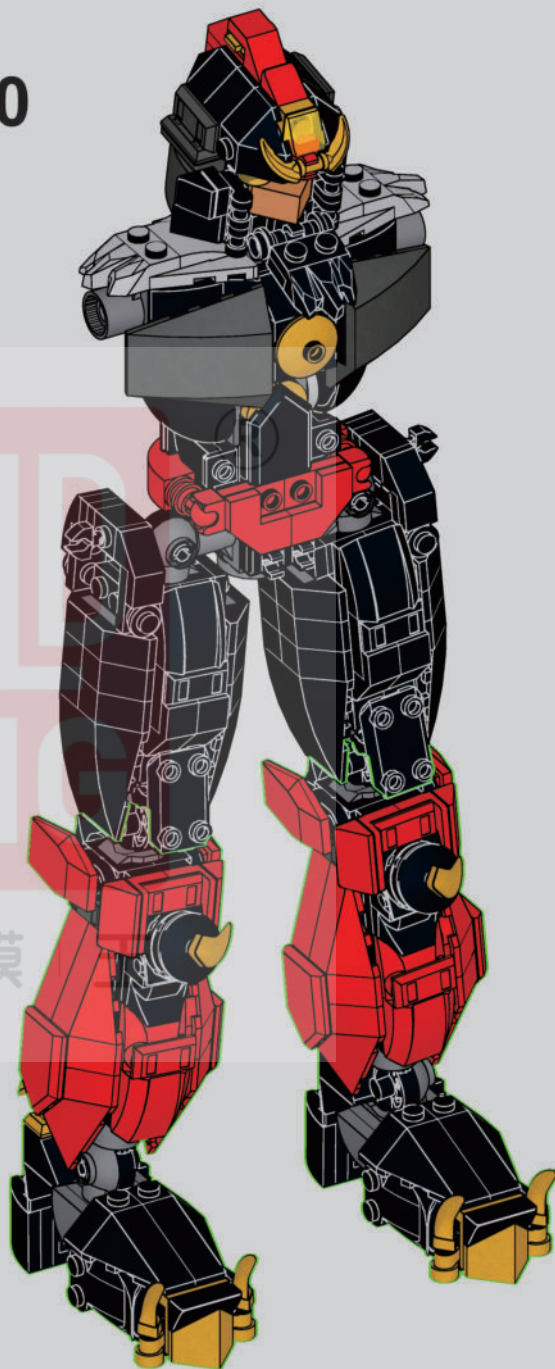

MOULD
KING
宇 | 星 | 模

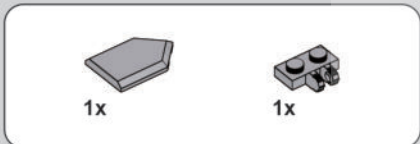
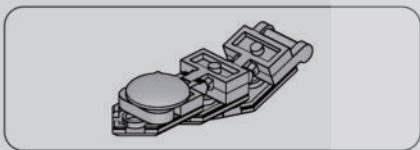

151

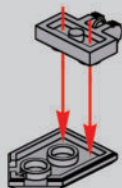

152

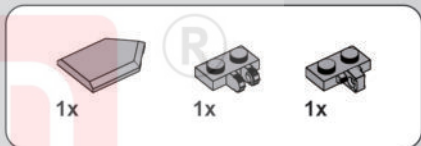
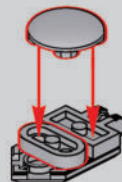

153

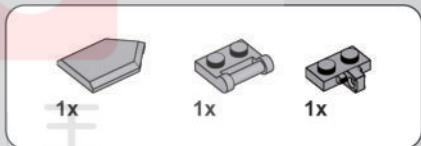
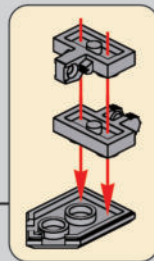
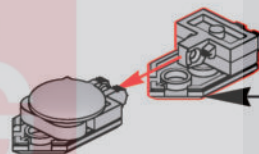

154

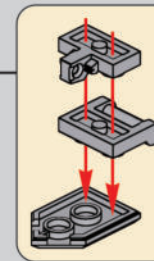
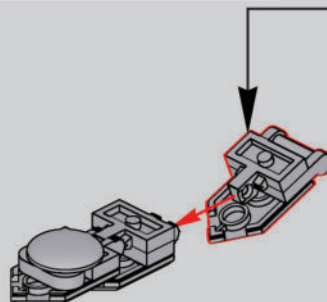

155

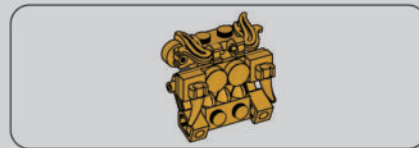
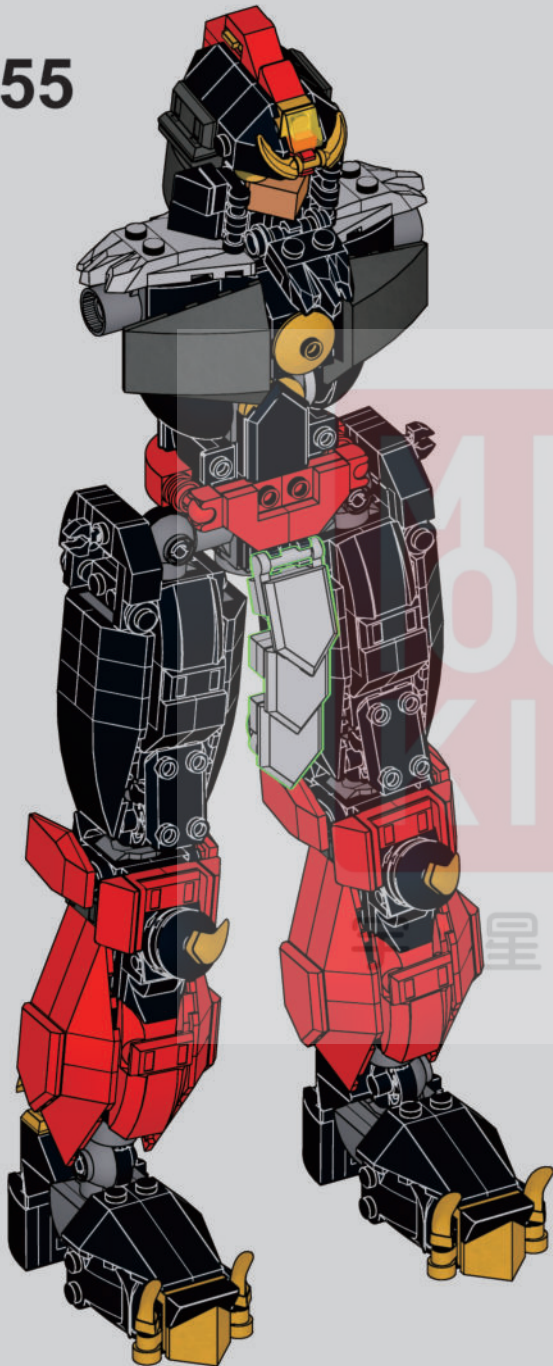

156



157



158

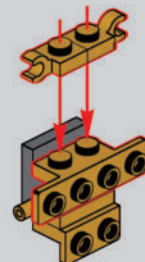
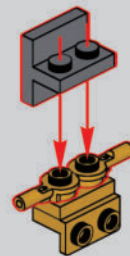
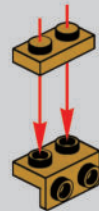

1x ↑ 2x ↑
 (Plating) (电镀配件)

159

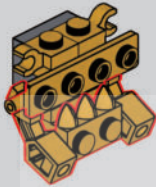

1x ↑ 2x ↑ 2x ↑ 2x ↑
 (Plating) (电镀配件)

160

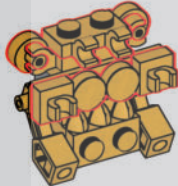

2x ↑ 2x ↑
 (Plating) (电镀配件)

161

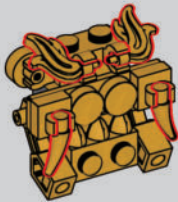

162

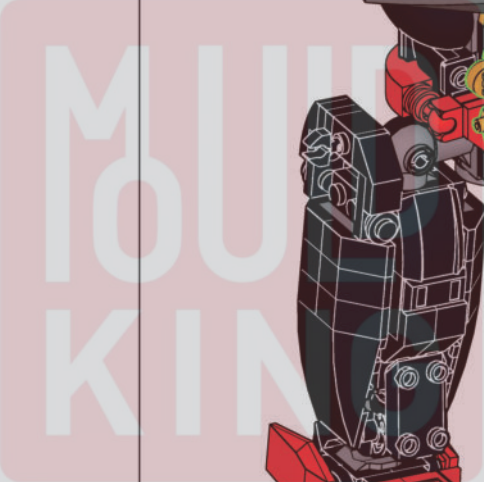
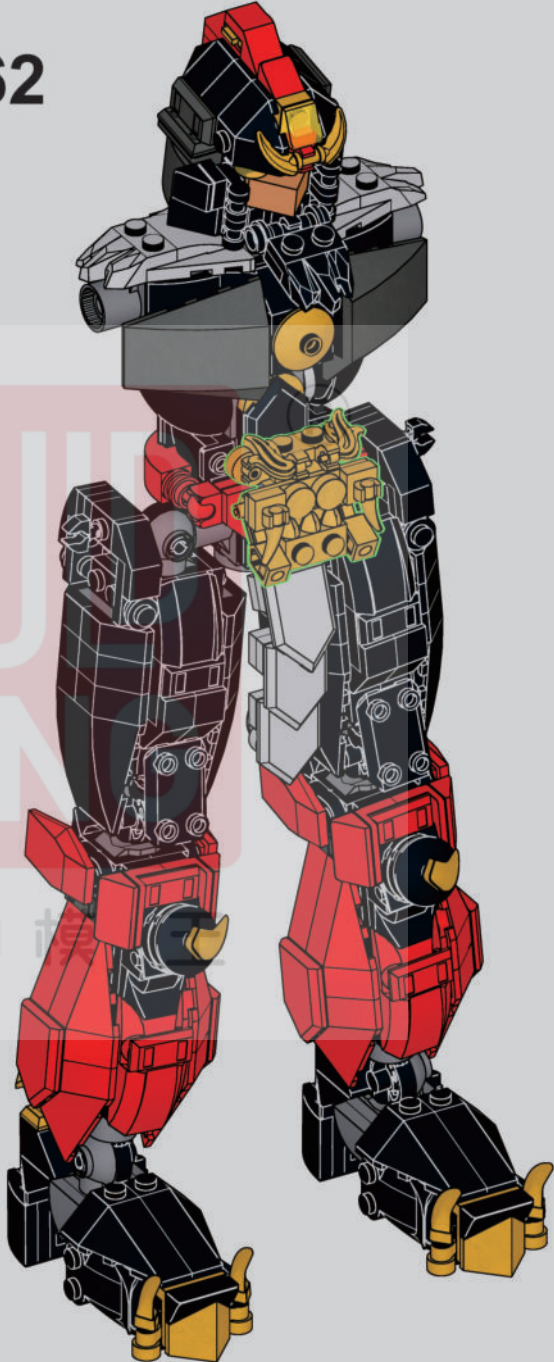

宇 | 星 | 模 | 组

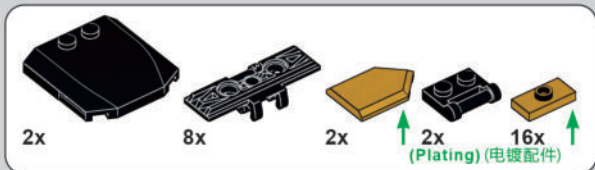

163

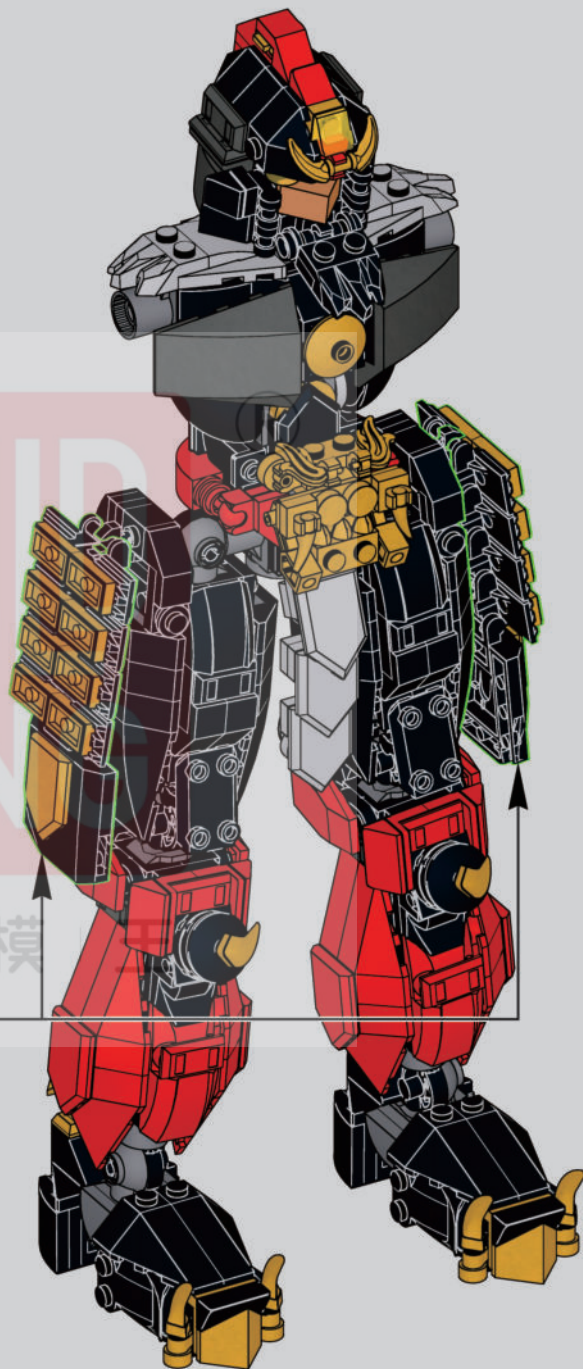
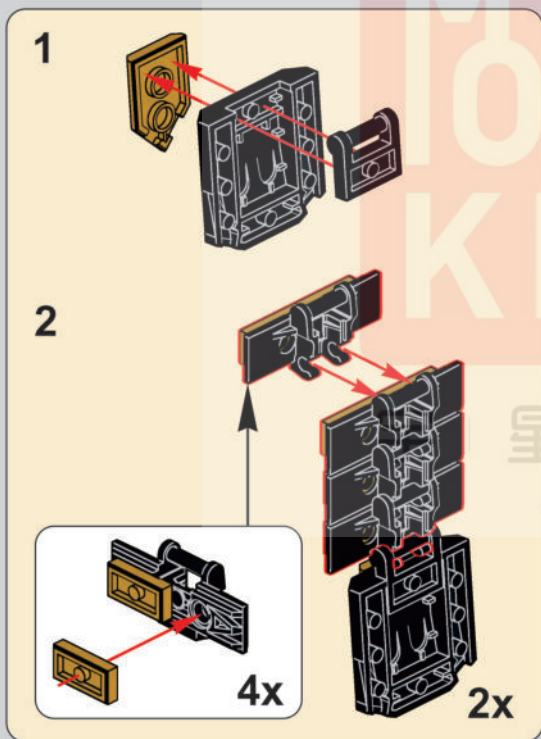

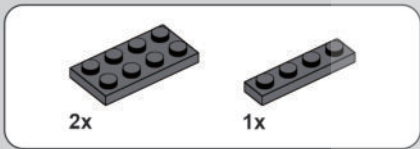
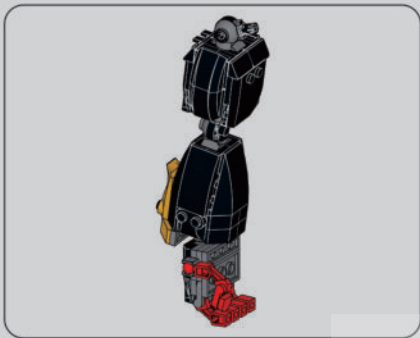

164

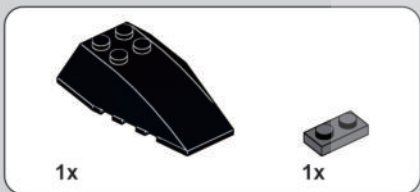
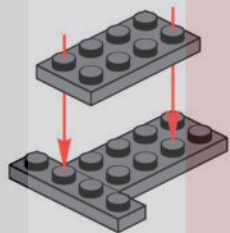

165

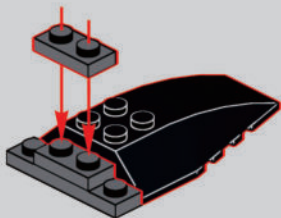

166

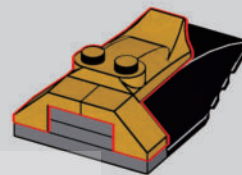

167

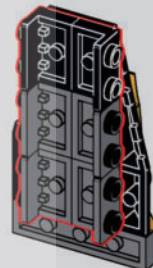

168

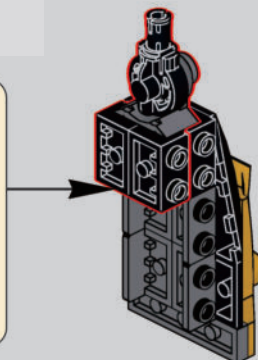
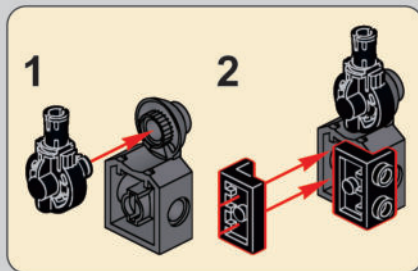

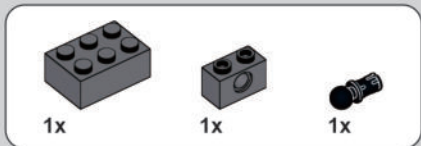

169

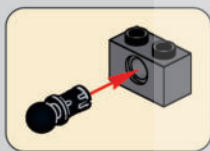
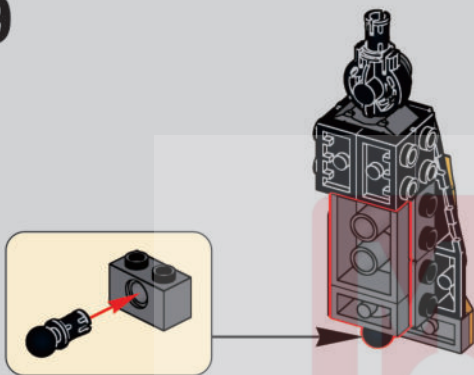

170

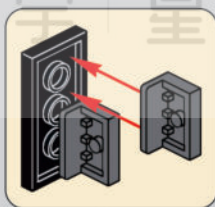
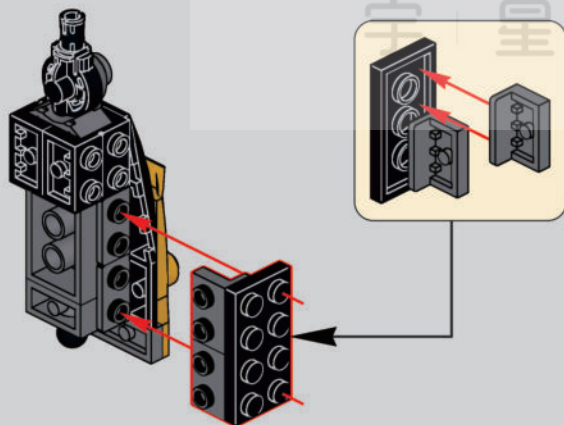

171

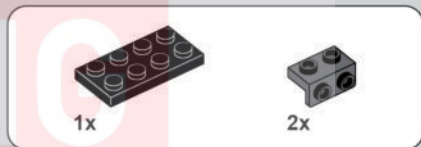
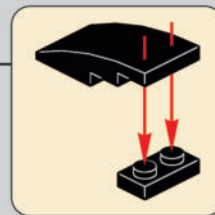
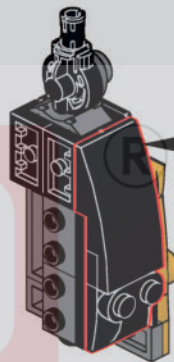

172

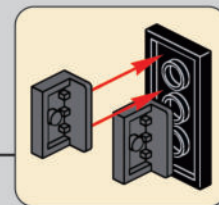
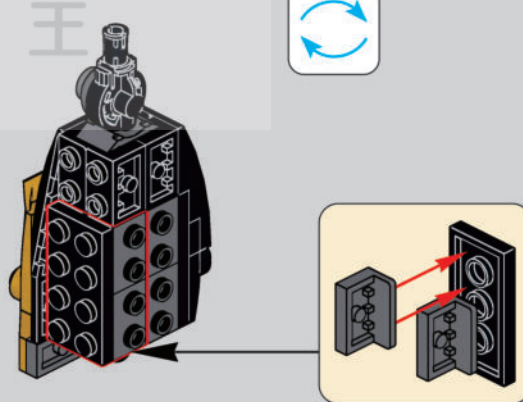

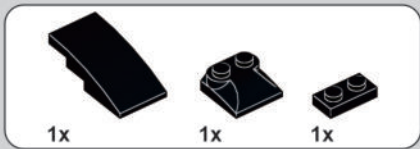

173

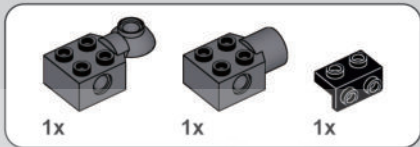
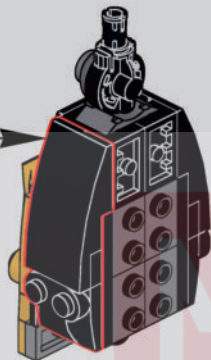
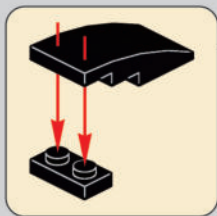

175

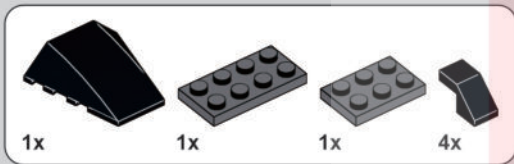
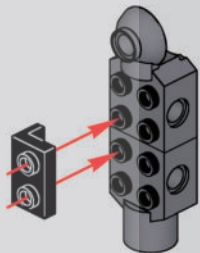

174

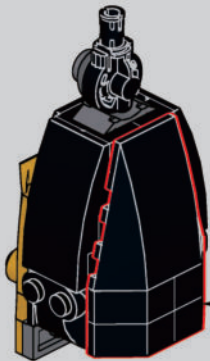
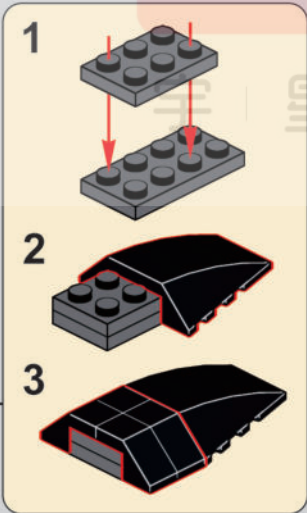

176

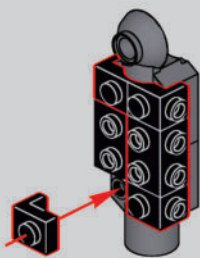



4x

177

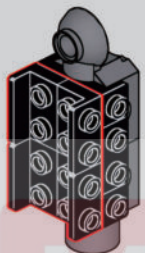

1x



1x

180

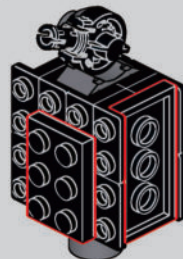

2x



4x

178

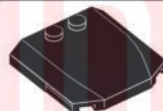
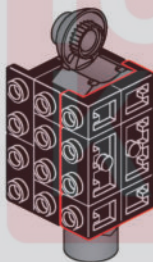

1x



2x



2x

181

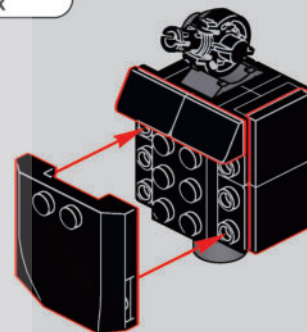

4x



1x

179

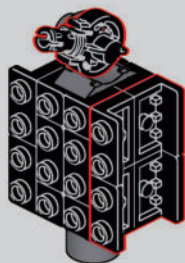

1x



2x



1x

182

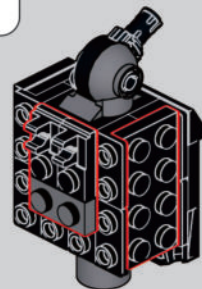

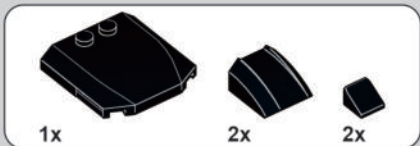

183

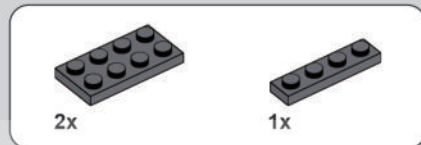
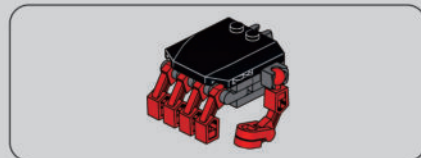
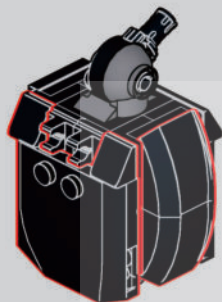

185

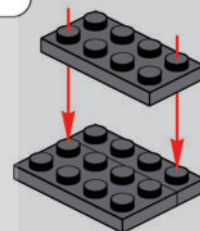

184

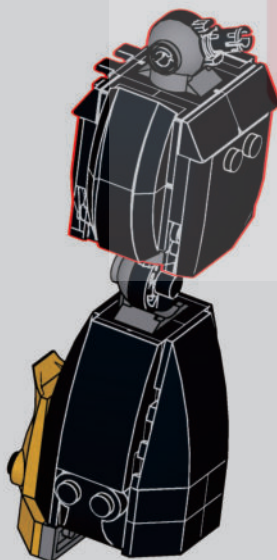

186

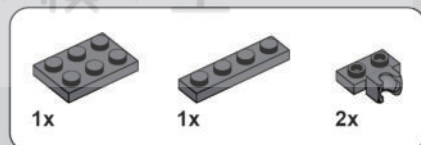
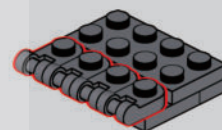

187

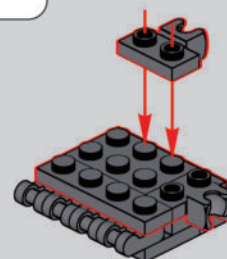

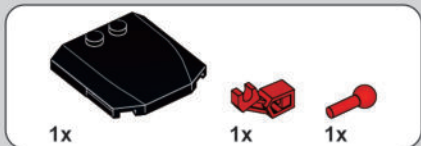

188

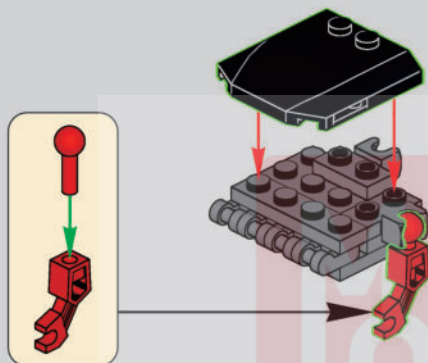

189

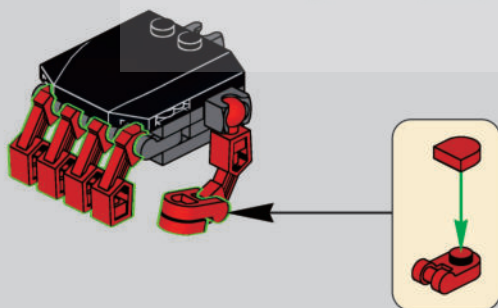

190



宇 | 星 | 模 | 王

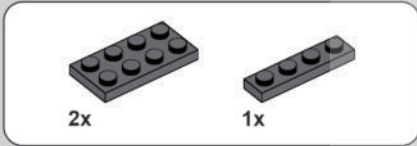
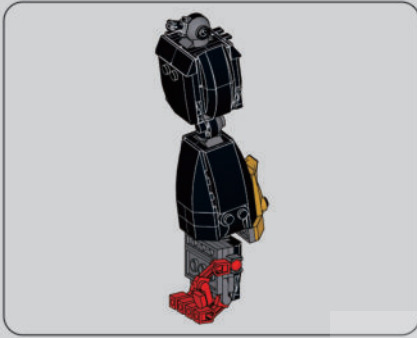

191

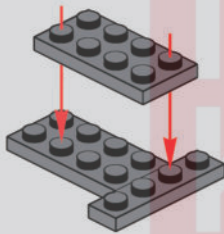

192

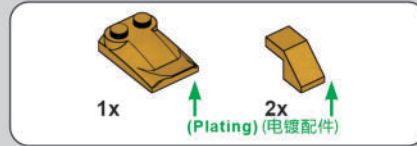
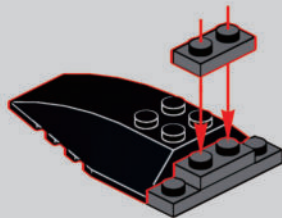

193

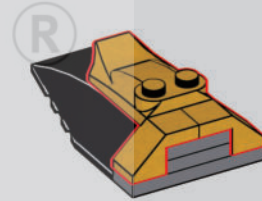

194

宇 | 星 | 模 | 王



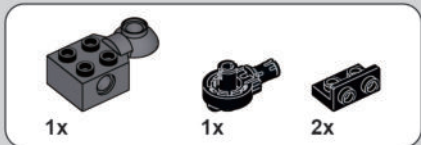

195

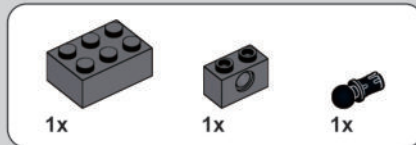
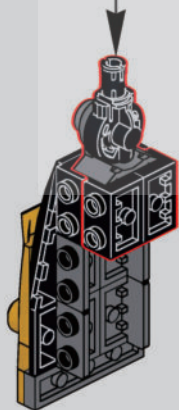
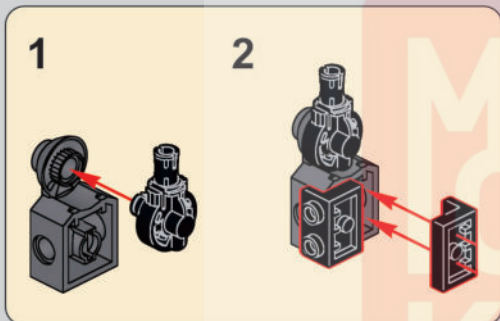

196

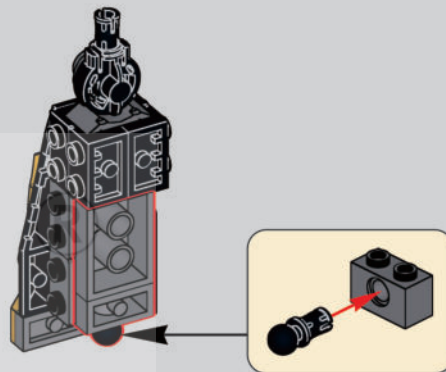

197

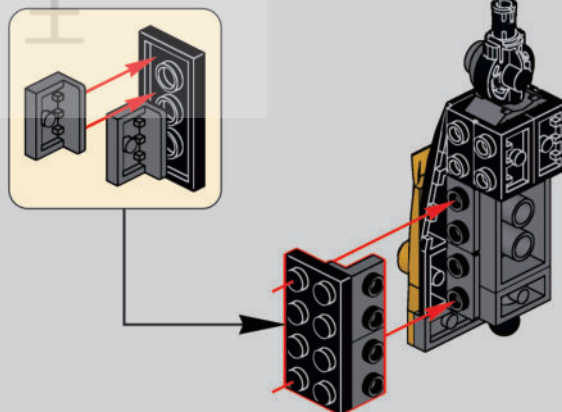

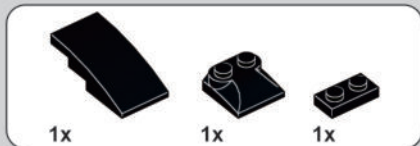

198

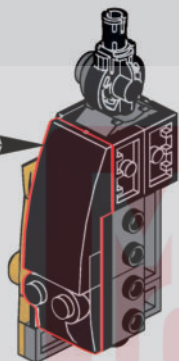
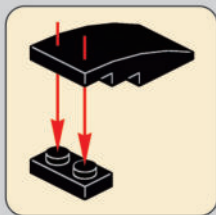

199

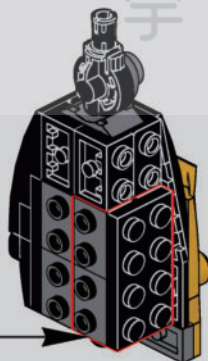
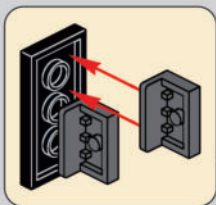

200

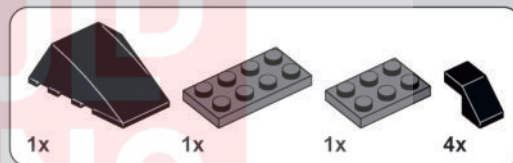
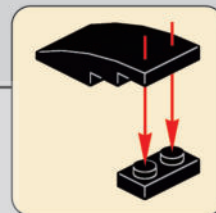

201

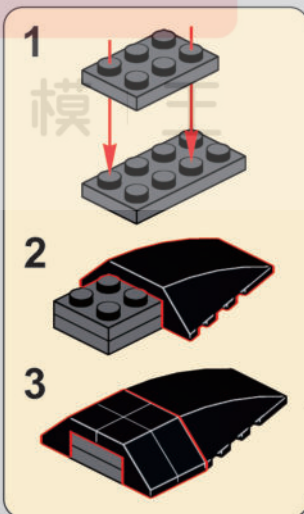

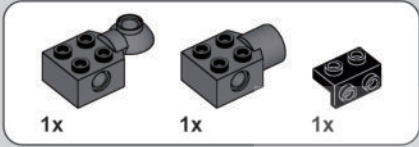

202

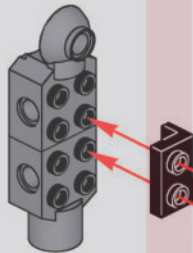

203

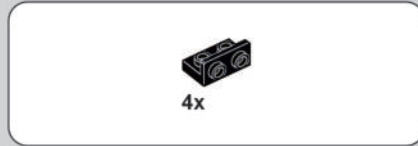
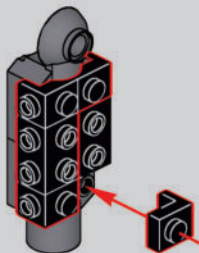

204

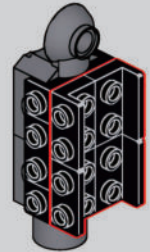

205

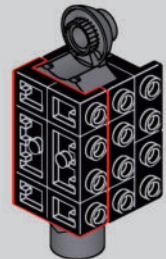

206

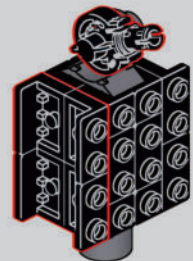

MOLD KING
宇 | 星 | 模 | 王



207

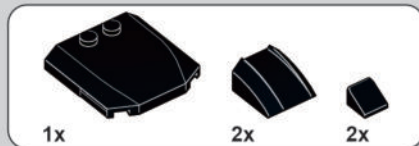
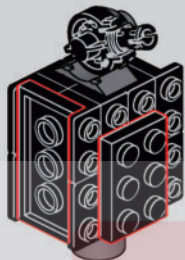

210

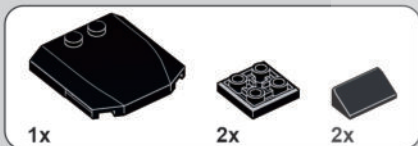
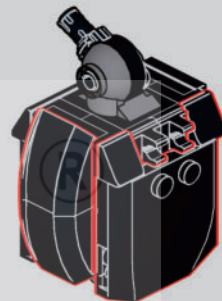

208

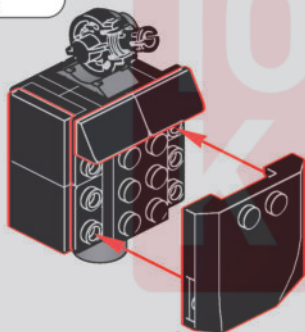

211

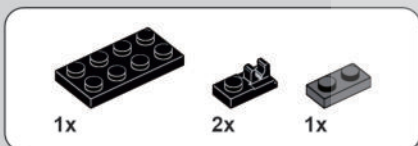

209

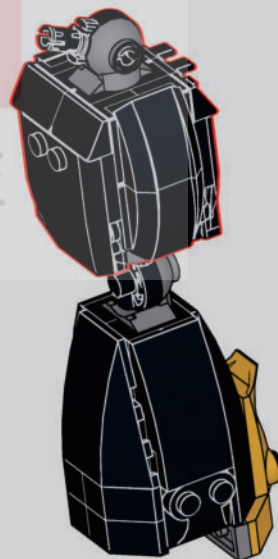
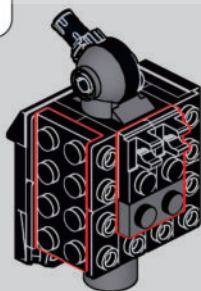

MOULD KING
宇 | 星 | 模 | 王

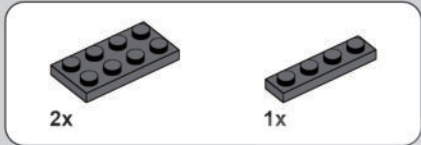
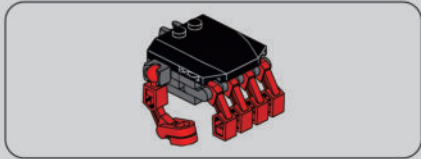

212

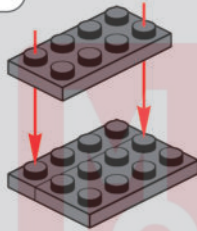

213

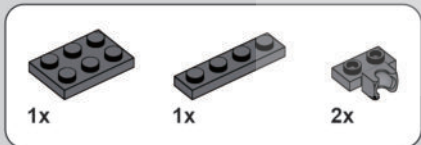
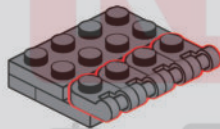

214

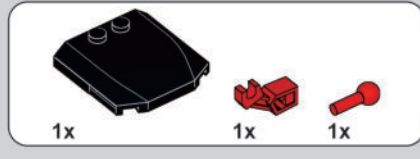
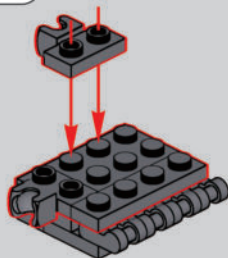

215

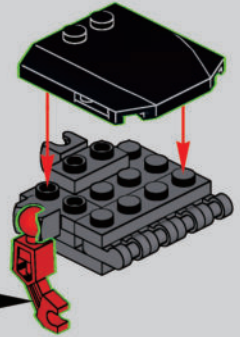
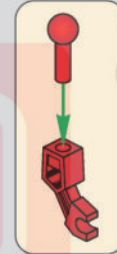

216

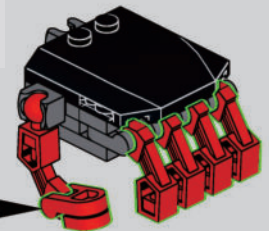
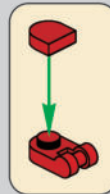

217

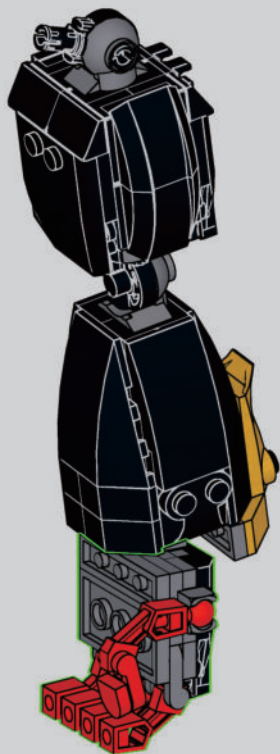

218



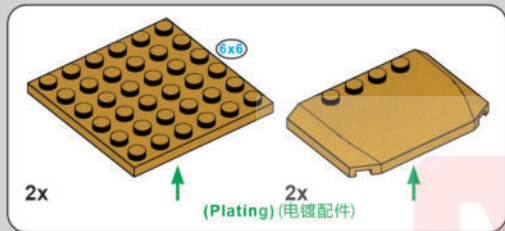
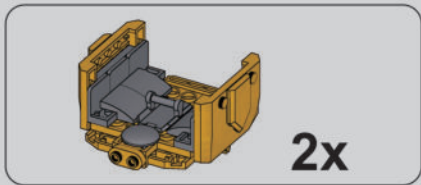

219

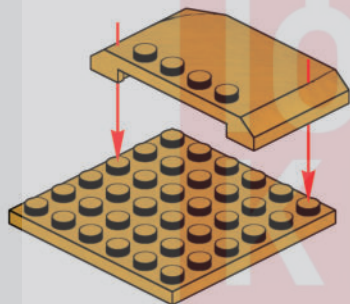

220

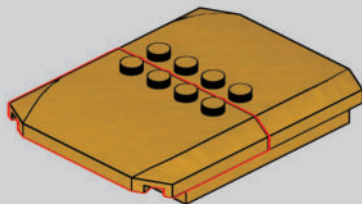

221

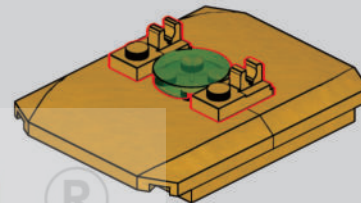

222

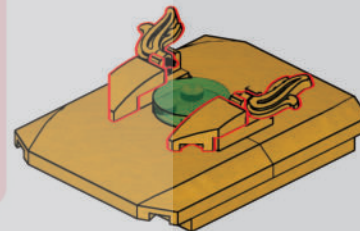

223

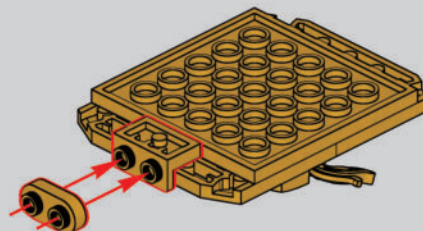



2x



2x

224

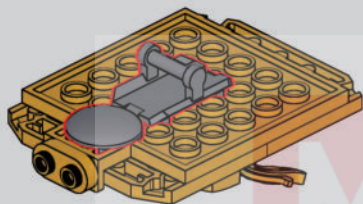

8x



4x

226

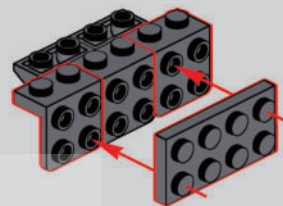

4x



4x

(Plating) (电镀配件)

227

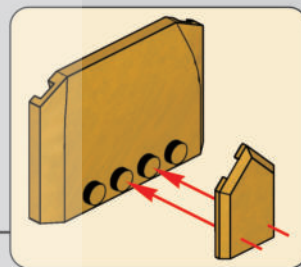

2x

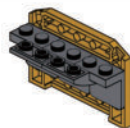

2x



4x



8x

225

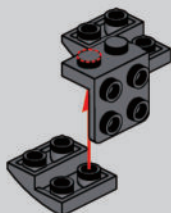

228

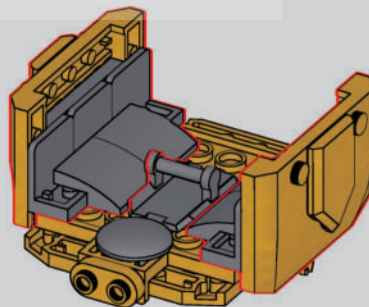

2x

229

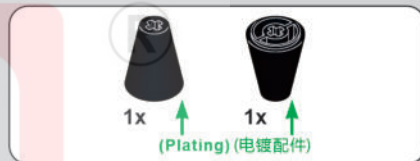
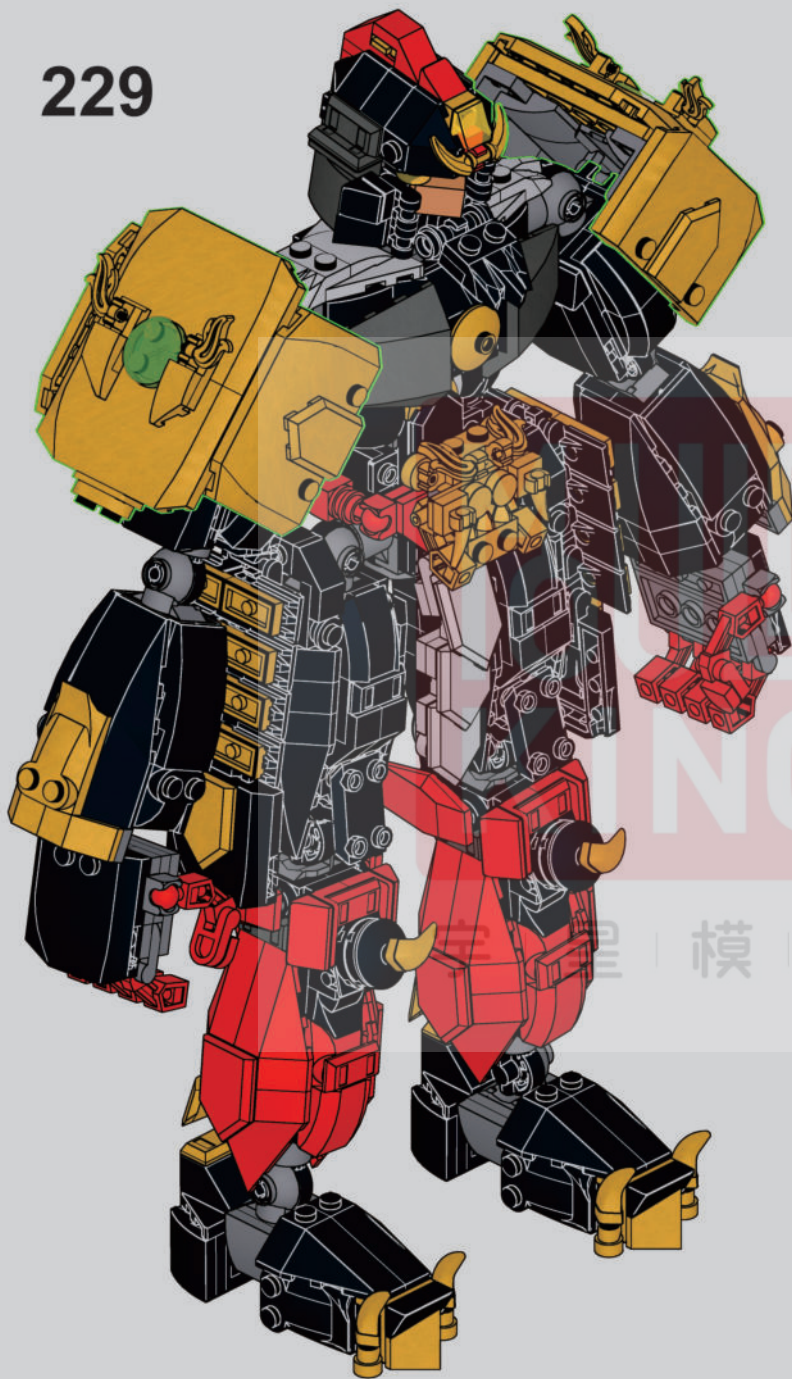

230



231

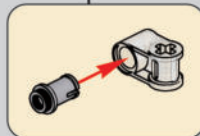

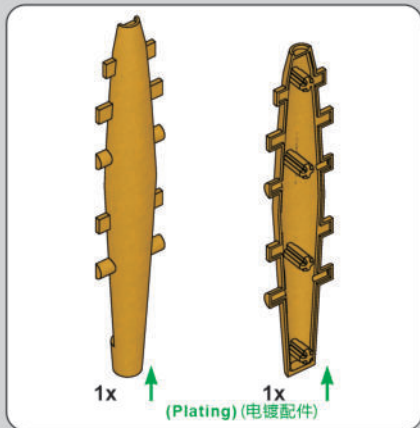

232

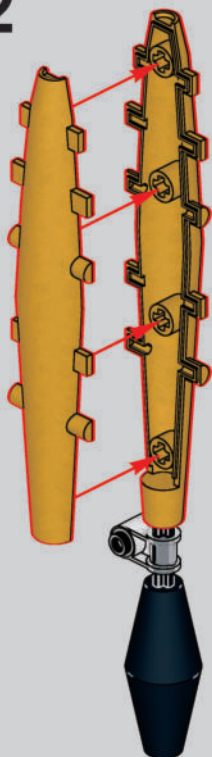

233

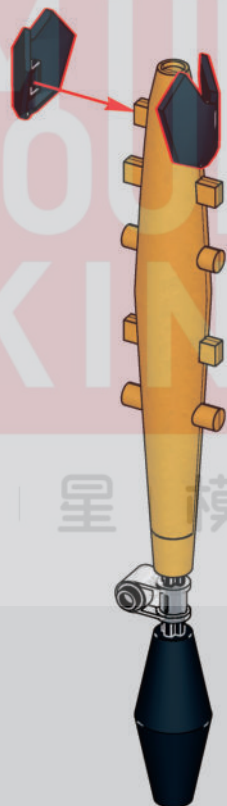

234

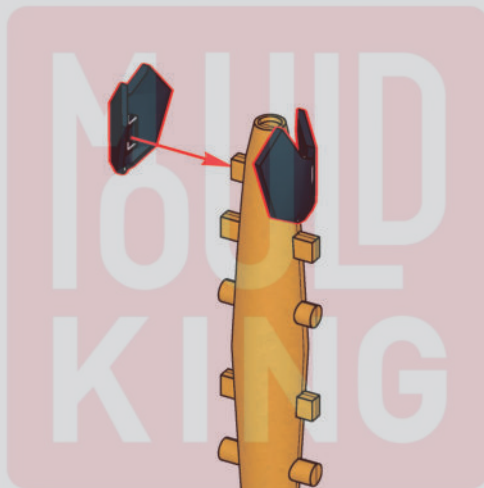
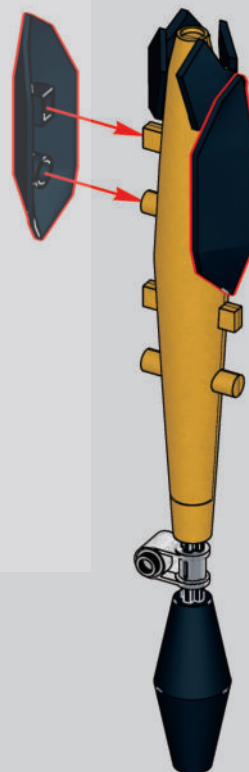

®

宇 | 星 | 模 | 王

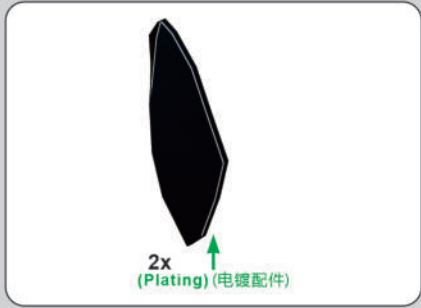

235

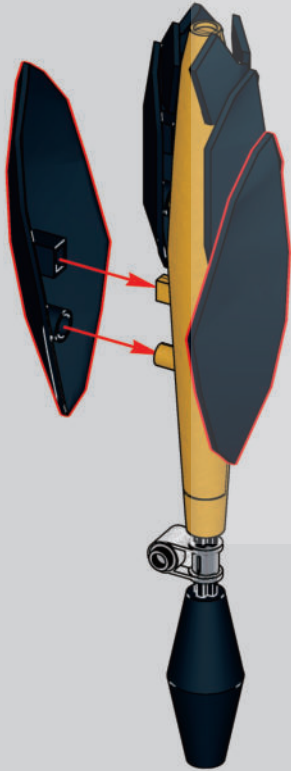

236

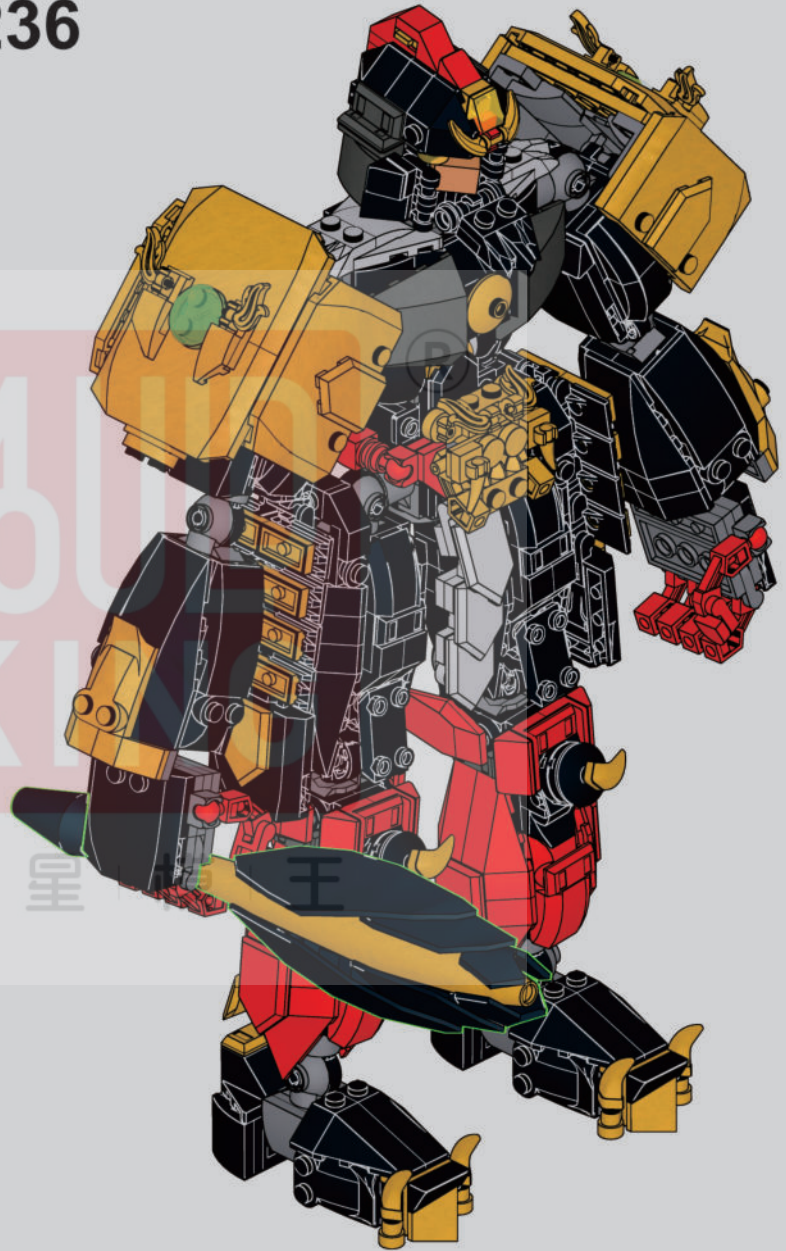

**MOULD
KING**

宇 | 星 | 模 | 王

®

